

3/8" KELEBEK SOMUN SIKMA-SÖKME



SM-401	\$57,20
Soket	3/8"
Max. Torku	10kg/m
Ağırlığı	0,96 Kg
Uzunluğu	140mm
Devir	10000d/dk
Çekiç Sistemi	Tek çekiç
Hava Girişi	1/4"

3/8" KELEBEK SOMUN SIKMA-SÖKME



SM-401A	\$90,80
Soket	3/8"
Max. Torku	12kg/m
Ağırlığı	1,00 Kg
Uzunluğu	140mm
Devir	10000d/dk
Çekiç Sistemi	Tek çekiç
Hava Girişi	1/4"

3/8" DÜZ TİP SOMUN SIKMA-SÖKME



SG-0775S	\$217,80
Soket	3/8"
Max. Torku	9,50kg/m
Ağırlığı	1,10 Kg
Uzunluğu	210mm
Devir	7000d/dk
Çekiç Sistemi	Çift çekiç
Hava Girişi	1/4"

3/8" KABZELİ SOMUN SIKMA-SÖKME



SG-0777	\$217,80
Soket	3/8"
Max. Torku	10kg/m
Ağırlığı	1,00 Kg
Uzunluğu	190mm
Devir	7000d/dk
Çekiç Sistemi	Çift çekiç
Hava Girişi	1/4"

3/8" KABZELİ SOMUN SIKMA-SÖKME



SG-0775	\$81,40
Soket	3/8"
Max. Torku	10kg/m
Ağırlığı	1,20 Kg
Uzunluğu	127mm
Devir	10000d/dk
Çekiç Sistemi	Tek çekiç
Hava Girişi	1/4"

3/8" KABZELİ SOMUN SIKMA-SÖKME



SM-41-4012P	\$151,30
Soket	3/8"
Max. Torku	34kg/m
Ağırlığı	1,20 Kg
Uzunluğu	153mm
Devir	10000d/dk
Çekiç Sistemi	İkiz gözlük çekiç
Hava Girişi	1/4"

Composite

Composit
Gövde
Düşük ses

1/2" KABZELİ SOMUN SIKMA-SÖKME

	SM-403	SM-403K
	\$60,50	\$84,70
Soket	1/2"	SET
Max. Torku	34kg/m	m9,10,11,13,14
Ağırlığı	2,40 Kg	17,19,22,24,27
Uzunluğu	160mm	Lokmalar
Devir	7000d/dk	Uzatma
Çekiç Sistemi	Tek çekiç	
Hava Girişi	1/4"	



1/2" KABZELİ SOMUN SIKMA-SÖKME



SG-0717	\$121,00
Soket	1/2"
Max. Torku	52kg/m
Ağırlığı	2,70 Kg
Uzunluğu	190mm
Devir	7000d/dk
Çekiç Sistemi	Pimli çekiç
Hava Girişi	1/4"

1/2" KABZELİ SOMUN SIKMA-SÖKME



SM-43-4038P	\$181,50
Soket	1/2"
Max. Torku	105kg/m
Ağırlığı	1,94 Kg
Uzunluğu	185mm
Devir	7500d/dk
Çekiç Sistemi	İkiz gözlük çekiç
Hava Girişi	1/4"

Composite

Composit
Gövde
Düşük ses

1/2" KABZELİ SOMUN SIKMA-SÖKME



SM-43-4131P1	\$181,50
Soket	1/2"
Max. Torku	78kg/m
Ağırlığı	2,08 Kg
Uzunluğu	186mm
Devir	9000d/dk
Çekiç Sistemi	İkiz gözlük çekiç
Hava Girişi	1/4"

Composite

Composit
Gövde
Düşük ses

1/2" KABZELİ SOMUN SIKMA-SÖKME



SM-43-4037G	\$174,90
Soket	1/2"
Max. Torku	90kg/m
Ağırlığı	2,70 Kg
Uzunluğu	185mm
Devir	9000d/dk
Çekiç Sistemi	İkiz gözlük çekiç
Hava Girişi	1/4"

1/2" KABZELİ MİNİ SOMUN SIKMA-SÖKME



SM-43-4012P	\$154,00
Soket	1/2"
Max. Torku	63kg/m
Ağırlığı	1,20 Kg
Uzunluğu	153mm
Devir	11000d/dk
Çekiç Sistemi	İkiz gözlük çekiç
Hava Girişi	1/4"

MINI

Composit
Gövde
Düşük ses

1/2" KABZELİ CIRCIR TİP MİNİ
SOMUN SIKMA-SÖKME



SM-43-4010	\$176,00
Soket	1/2"
Max. Torku	32kg/m
Ağırlığı	1,19 Kg
Uzunluğu	88mm
Devir	8000d/dk
Çekiç Sistemi	Tekli gözlük çekiç
Hava Girişi	1/4"

MINI

Composit
Gövde
Düşük ses

3/4" KABZELİ SOMUN SIKMA-SÖKME



SG-0740	\$148,50
Soket	3/4"
Max. Torku	68kg/m
Ağırlığı	4,80 Kg
Uzunluğu	242mm
Devir	4500d/dk
Çekiç Sistemi	Tek çekiç
Hava Girişi	1/4"

3/4" KABZELİ SOMUN SIKMA-SÖKME



SG-0751	\$242,00
Soket	3/4"
Max. Torku	95kg/m
Ağırlığı	4,80 Kg
Uzunluğu	248mm
Devir	4800d/dk
Çekiç Sistemi	Pimli çekiç
Hava Girişi	1/4"

3/4" KABZELİ SOMUN SIKMA-SÖKME



SG-0752	\$302,50
Soket	3/4"
Max. Torku	102kg/m
Ağırlığı	4,50 Kg
Uzunluğu	229mm
Devir	6500d/dk
Çekiç Sistemi	İkiz gözlük çekiç
Hava Girişi	1/4"

3/4" KABZELİ SOMUN SIKMA-SÖKME



SM-45-4153P	\$453,80
Soket	3/4"
Max. Torku	150kg/m
Ağırlığı	3,79 Kg
Uzunluğu	220mm
Devir	5500d/dk
Çekiç Sistemi	İkiz gözlük çekiç
Hava Girişi	3/8"

Composite

Composit
Gövde
Düşük ses

3/4" KABZELİ SOMUN SIKMA-SÖKME



SM-45-4057G	\$313,50
Soket	3/4"
Max. Torku	150kg/m
Ağırlığı	4,60 Kg
Uzunluğu	220mm
Devir	5500d/dk
Çekiç Sistemi	İkiz gözlük çekiç
Hava Girişi	3/8"

3/4" KABZELİ SOMUN SIKMA-SÖKME



	SM-45-4051P	SM-45-4051PL
	\$453,80	\$502,20
Soket	3/4"-Kısa	3/4"-Uzun
Max. Torku	190kg/m	190kg/m
Ağırlığı	3,30 Kg	3,90 Kg
Uzunluğu	215mm	368mm
Devir	5500d/dk	5500d/dk
Çekiç Sistemi	İkiz gözlük çekiç	İkiz gözlük çekiç
Hava Girişi	3/8"	3/8"

Composite

Composit
Gövde
Düşük ses

1" KABZELİ SOMUN SIKMA-SÖKME



	SG-0707S	SG-0707L
	\$473,00	\$514,30
Soket	1"-Kısa	1"-Uzun
Max. Torku	163kg/m	163kg/m
Ağırlığı	11,00 Kg	12,80 Kg
Uzunluğu	455mm	582mm
Devir	3500d/dk	3500d/dk
Çekiç Sistemi	Pimli çekiç	Pimli çekiç
Hava Girişi	3/8"	3/8"

1" KABZELİ SOMUN SIKMA-SÖKME



	SG-0706S	SG-0706L
	\$592,90	\$641,30
Soket	1"-Kısa	1"-Uzun
Max. Torku	245kg/m	245kg/m
Ağırlığı	9,00 Kg	10,00 Kg
Uzunluğu	302mm	429mm
Devir	3500d/dk	3500d/dk
Çekiç Sistemi	Pimli çekiç	Pimli çekiç
Hava Girişi	1/2"	1/2"

1" DÜZ TİP SOMUN SIKMA-SÖKME

SG-0705S	SG-0705L
\$473,00	\$514,30

Soket	1"-Kısa	1"-Uzun
Max. Torku	163kg/m	163kg/m
Ağırlığı	12,00 Kg	12,20 Kg
Uzunluğu	302mm	429mm
Devir	3500d/dk	3500d/dk
Çekiç Sistemi	Tek çekiç	Tek çekiç
Hava Girişi	3/8"	3/8"



1" DÜZ TİP SOMUN SIKMA-SÖKME

SG-0704S	SG-0704L
\$592,90	\$641,30

Soket	1"-Kısa	1"-Uzun
Max. Torku	245kg/m	245kg/m
Ağırlığı	11,00 Kg	12,80 Kg
Uzunluğu	432mm	582mm
Devir	3500d/dk	3500d/dk
Çekiç Sistemi	Pimli çekiç	Pimli çekiç
Hava Girişi	1/2"	1/2"



1" KABZELİ SOMUN SIKMA-SÖKME

SM-47-4051P	SM-47-4051PL
\$514,30	\$544,50

Soket	1"-Kısa	1"-Uzun
Max. Torku	190kg/m	190kg/m
Ağırlığı	3,40 Kg	4,30 Kg
Uzunluğu	223mm	370mm
Devir	5500d/dk	5500d/dk
Çekiç Sistemi	İkiz gözlük çekiç	İkiz gözlük çekiç
Hava Girişi	3/8"	3/8"



Composite

Composit
Gövde
Düşük ses

1/2" TORK KONTROLLÜ SOMUN SIKMA-SÖKME

SM-43-4033A	\$181,50
Soket	1/2"
Sıkma Torku	9-13kg/m
Sökme Torku	81kg/m
Ağırlığı	1,90 Kg
Uzunluğu	183mm
Devir	8000d/dk
Çekiç Sistemi	İkiz gözlük çekiç
Hava Girişi	1/4"

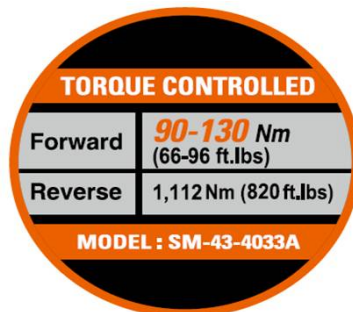

TORQUE CONTROLLED

Forward	90-130 Nm (66-96 ft.lbs)
Reverse	1,112 Nm (820 ft.lbs)

MODEL : SM-43-4033A



1/4"-3/8"-1/2" CIRCIR



	SM-32-3100	SM-30	SM-31
	\$59,40	\$48,40	\$48,40
Soket	1/4"	3/8"	1/2"
Max. Torku	4,15kg/m	7,00kg/m	7,00kg/m
Ağırlığı	0,50 Kg	1,20 Kg	1,20 Kg
Uzunluğu	168mm	255mm	255mm
Devir	300d/dk	150d/dk	150d/dk
Hava Girişi	1/4"	1/4"	1/4"



1/2" CIRCIR



SM-34-3117	\$181,50
Soket	1/2"
Max. Torku	10,20kg/m
Ağırlığı	1,28 Kg
Uzunluğu	280mm
Devir	400d/dk
Hava Girişi	1/4"

Composite

Composit
Gövde
Düşük ses
Otomotiv
Grubu

1/2" CIRCIR



SG-0735	\$157,30
Soket	1/2"
Max. Torku	12kg/m
Ağırlığı	2,00 Kg
Uzunluğu	365mm
Devir	150d/dk
Hava Girişi	1/4"

KABZELİ TORNAVİDA



Dıştan Tork Ayarlı	SM-882	SM-883
	\$250,80	\$276,10
Uç Ölçüsü	1/4"	1/4"
Kapasitesi	6mm	6mm
Çalışma Torku	5-13nm	5-16,4nm
Ağırlığı	1,35 Kg	1,50 Kg
Uzunluğu	228mm	254mm
Devir	1800d/dk	800d/dk
Hava Girişi	1/4"	1/4"

KABZELİ TORNAVİDA



SM-AS002	\$363,00
Uç Ölçüsü	1/4"
Kapasitesi	6mm
Çalışma Torku	0,2-5,1nm
Ağırlığı	0,90 Kg
Uzunluğu	210mm
Devir	600d/dk
Hava Girişi	1/4"

Auto Shut-Off

Dıştan
Tork
Ayarlı
Düşük ses
2 Adet
Tork Yay
Shut-Off

KABZELİ TORNAVİDA

SM-AS102A	\$363,00
Uç Ölçüsü	1/4"
Kapasitesi	6mm
Çalışma Torku	0,4-4,5nm
Ağırlığı	0,90 Kg
Uzunluğu	210mm
Devir	1000d/dk
Hava Girişi	1/4"



Auto Shut-Off

Dıştan
Tork
Ayarlı
Düşük ses
2 Adet
Tork Yayı
Shut-Off

KABZELİ TORNAVİDA



SM-82-7251F	\$189,20
Uç Ölçüsü	1/4"
Kapasitesi	6mm
Çalışma Torku	5-13nm
Ağırlığı	1,30 Kg
Uzunluğu	196mm
Devir	1800d/dk
Hava Girişi	1/4"

Composite

Kompozit
Gövde
Dıştan
Tork
Ayarlı
Düşük ses

KABZELİ TORNAVİDA



SM-AS104	\$363,00
Uç Ölçüsü	1/4"
Kapasitesi	6mm
Çalışma Torku	0,4-4,5nm
Ağırlığı	0,90 Kg
Uzunluğu	216mm
Devir	1000d/dk
Hava Girişi	1/4"

Auto Shut-Off

Dıştan
Tork
Ayarlı
Düşük ses
Shut-Off

KABZELİ TORNAVİDA



Composite

Kompozit Gövde Düşük ses	SM-82-7254P	SM-83-7254P
	\$189,20	\$223,90
Uç Ölçüsü	1/4"	1/4"
Kapasitesi	6mm	6mm
Çalışma Torku	5-13nm	5-16,4nm
Ağırlığı	1,30 Kg	1,40 Kg
Uzunluğu	196mm	214mm
Devir	1800d/dk	800d/dk
Hava Girişi	1/4"	1/4"

KABZELİ TORNAVİDA



Composite

Kompozit Gövde Dıştan Tork Ayarlı Düşük ses	SM-82-7254PF	SM-83-7254PF
	\$189,20	\$223,90
Uç Ölçüsü	1/4"	1/4"
Kapasitesi	6mm	6mm
Çalışma Torku	1,2-11nm	1,2-12,4nm
Ağırlığı	1,30 Kg	1,40 Kg
Uzunluğu	196mm	214mm
Devir	1800d/dk	800d/dk
Hava Girişi	1/4"	1/4"

KABZELİ TORNAVİDA



SG-0907	\$210,70
Uç Ölçüsü	1/4"
Kapasitesi	10mm
Çalışma Torku	1,22-16,4nm
Ağırlığı	1,00 Kg
Uzunluğu	190mm
Devir	7000d/dk
Hava Girişi	1/4"

Darbeli

KABZELİ TORNAVİDA



	SM-802	SM-803
	\$92,40	\$116,60
Uç Ölçüsü	1/4"	1/4"
Kapasitesi	6mm	6mm
Çalışma Torku	5-13nm	5-16,4nm
Ağırlığı	1,15 Kg	1,20 Kg
Uzunluğu	178mm	216mm
Devir	1800d/dk	800d/dk
Hava Girişi	1/4"	1/4"

KABZELİ TORNAVİDA



SM-88-8020	\$81,00
Ağırlığı	1,00 Kg
Uzunluğu	180mm
Devir	1800d/dk
Hava Girişi	1/4"

DÜZ TİP TORNAVİDA



Dıştan
Tork
Ayarlı

	SM-872	SM-873
	\$283,30	\$312,40
Uç Ölçüsü	1/4"	1/4"
Kapasitesi	6mm	6mm
Çalışma Torku	5-13nm	5-16,4nm
Ağırlığı	1,35 Kg	1,50 Kg
Uzunluğu	266mm	293mm
Devir	1800d/dk	800d/dk
Hava Girişi	1/4"	1/4"

DÜZ TİP TORNAVİDA



	SM-AS005	SM-AS105	SM-AS205
	\$363,00	\$363,00	\$363,00
Uç Ölçüsü	1/4"	1/4"	1/4"
Kapasitesi	6mm	6mm	6mm
Çalışma Torku	0,5-5,1nm	0,3-4,5nm	0,3-2,9nm
Ağırlığı	0,70 Kg	0,70 Kg	0,70 Kg
Uzunluğu	240mm	240mm	240mm
Devir	650d/dk	1100d/dk	1800d/dk
Hava Girişi	1/4"	1/4"	1/4"

Auto Shut-Off

Dıştan
Tork
Ayarlı

Düşük ses
2 Adet
Tork Yayı

DÜZ TİP TORNAVIDA

	SM-82-8423F	SM-83-8423F
	\$271,20	\$286,00
Uç Ölçüsü	1/4"	1/4"
Kapasitesi	6mm	6mm
Çalışma Torku	1,2-11nm	1,2-12,4nm
Ağırlığı	1,20 Kg	1,40 Kg
Uzunluğu	265mm	283mm
Devir	1800d/dk	800d/dk
Hava Girişi	1/4"	1/4"



Composite

Dıştan
Tork
Ayarlı

Düşük ses
Kompozit
Gövde

DÜZ TİP TORNAVIDA

SG-0909	\$90,80
Uç Ölçüsü	1/4"
Kapasitesi	6mm
Çalışma Torku	1,2-3,4nm
Ağırlığı	0,60 Kg
Uzunluğu	210mm
Devir	1500d/dk
Hava Girişi	1/4"



DÜZ TİP TORNAVIDA



	SM-842	SM-843
	\$133,10	\$145,20
Uç Ölçüsü	1/4"	1/4"
Kapasitesi	6mm	6mm
Çalışma Torku	5-13nm	5-16,4nm
Ağırlığı	1,05 Kg	1,20 Kg
Uzunluğu	255mm	280mm
Devir	1800d/dk	800d/dk
Hava Girişi	1/4"	1/4"

DÜZ TİP TORNAVIDA



SG-0907S	\$210,70
Uç Ölçüsü	1/4"
Kapasitesi	10mm
Çalışma Torku	1,2-15nm
Ağırlığı	1,00 Kg
Uzunluğu	210mm
Devir	7000d/dk
Hava Girişi	1/4"

Darbeli

DÜZ TİP TORNAVIDA



SG-0905	\$101,80
Uç Ölçüsü	1/4"
Kapasitesi	6mm
Çalışma Torku	2,2-7nm
Ağırlığı	0,70 Kg
Uzunluğu	190mm
Devir	8000d/dk
Hava Girişi	1/4"

Darbeli

DÜZ TİP TORNAVIDA



SG-0320	\$187,00
Uç Ölçüsü	1/4"
Kapasitesi	6mm
Çalışma Torku	2,2-7nm
Ağırlığı	0,67 Kg
Uzunluğu	195mm
Devir	9000d/dk
Hava Girişi	1/4"

Auto Shut-Off

Darbeli

6mm KABZELİ MATKAP



SM-78-7284PR-02	\$137,50
Mandren	6mm
Tip	Sağ-Sol
Ağırlığı	0,60 Kg
Uzunluğu	148mm
Devir	2600d/dk
Hava Girişi	1/4"

Composite

Kompozit
Gövde
Düşük ses

10mm KABZELİ MATKAP



SM-706	\$59,40
Mandren	10mm
Tip	Sağ
Ağırlığı	1,15 Kg
Uzunluğu	165mm
Devir	2600d/dk
Hava Girişi	1/4"

10mm KABZELİ MATKAP



SM-701	\$72,60
Mandren	10mm
Tip	Sağ
Ağırlığı	1,15 Kg
Uzunluğu	165mm
Devir	2200d/dk
Hava Girişi	1/4"

10mm KABZELİ MATKAP



SM-76-7254P	\$128,70
Mandren	10mm
Tip	Sağ
Ağırlığı	1,10 Kg
Uzunluğu	185mm
Devir	2600d/dk
Hava Girişi	1/4"

Composite

10mm KABZELİ MATKAP



SM-7026A	\$247,50
Mandren	10mm
Tip	Sağ
Ağırlığı	1,00 Kg
Uzunluğu	200mm
Devir	2600d/dk
Hava Girişi	1/4"

1 hp güç
Tetikten
2 hız
Ayarlı

10mm KABZELİ MATKAP



SM-705	\$60,50
Mandren	10mm
Tip	Sağ-Sol
Ağırlığı	1,35 Kg
Uzunluğu	165mm
Devir	1800d/dk
Hava Girişi	1/4"

10mm KABZELİ MATKAP



SM-75-7254P	\$133,10
Mandren	10mm
Tip	Sağ-Sol
Ağırlığı	1,10 Kg
Uzunluğu	185mm
Devir	1800d/dk
Hava Girişi	1/4"

Composite

Kompozit
Gövde
Düşük ses
2 Hızlı
tetik

10mm DÜZ TİP MATKAP



SM-746	\$108,90
Mandren	10mm
Tip	Sağ
Ağırlığı	0,90 Kg
Uzunluğu	190mm
Devir	4500d/dk
Hava Girişi	1/4"

10mm DÜZ TİP MATKAP



SM-710	\$96,80
Mandren	10mm
Tip	Sağ
Ağırlığı	0,90 Kg
Uzunluğu	216mm
Devir	2600d/dk
Hava Girişi	1/4"

10mm DÜZ TİP MATKAP



SM-502	\$47,30
Mandren	10mm
Tip	Sağ
Ağırlığı	0,70 Kg
Uzunluğu	186mm
Devir	2200d/dk
Hava Girişi	1/4"

10mm DÜZ TİP MATKAP



SM-76-3011B	\$175,50
Mandren	10mm
Tip	Sağ
Ağırlığı	1,10 Kg
Uzunluğu	241mm
Devir	2500d/dk
Hava Girişi	1/4"

Composite

Kompozit
Gövde
Düşük ses

10mm 90° MATKAP



SM-709	\$119,90
Mandren	10mm
Tip	Sağ
Ağırlığı	1,15 Kg
Uzunluğu	204mm
Devir	1900d/dk
Hava Girişi	1/4"

10mm 90° MATKAP



SM-709R	\$127,10
Mandren	10mm
Tip	Sağ-Sol
Ağırlığı	1,80 Kg
Uzunluğu	178mm
Devir	1500d/dk
Hava Girişi	1/4"

13mm KABZELİ MATKAP



SM-704	\$116,60
Mandren	13mm
Tip	Sağ-Sol
Ağırlığı	1,80 Kg
Uzunluğu	178mm
Devir	800d/dk
Hava Girişi	1/4"

13mm KABZELİ MATKAP



SM-703	\$96,80
Mandren	13mm
Tip	Sağ
Ağırlığı	1,80 Kg
Uzunluğu	178mm
Devir	500d/dk
Hava Girişi	1/4"

13mm KABZELİ MATKAP



SM-72-7254P	\$163,40
Mandren	13mm
Tip	Sağ
Ağırlığı	1,30 Kg
Uzunluğu	218mm
Devir	1000d/dk
Hava Girişi	1/4"

Composite

Kompozit
Gövde
Düşük ses
2 Hızlı
tetik

13mm KABZELİ MATKAP



SM-74-7251	\$170,50
Mandren	13mm
Tip	Sağ-Sol
Ağırlığı	1,70 Kg
Uzunluğu	224mm
Devir	800d/dk
Hava Girişi	1/4"

Composite

Kompozit
Gövde
Düşük ses

13mm KABZELİ MATKAP



SM-74-7254P	\$170,50
Mandren	13mm
Tip	Sağ-Sol
Ağırlığı	1,30 Kg
Uzunluğu	218mm
Devir	800d/dk
Hava Girişi	1/4"

Composite

Kompozit
Gövde
Düşük ses
2 Hızlı
tetik

16mm MATKAP



SM-7H-7538	\$943,80
Mandren	16mm
Tip	Sağ
Ağırlığı	3,30 Kg
Uzunluğu	328mm
Devir	800d/dk
Hava Girişi	1/4"

Ağır
Hizmet

PUNTA ÇÜRÜTME



SM-721	\$240,90
Punta Mat. Ölçüsü	8mm
Ağırlığı	2,50 Kg
Uzunluğu	250mm
Devir	2000d/dk
Hava Girişi	1/4"

PUNTA ÇÜRÜTME



SM-71-7802	\$412,50
Punta Mat. Ölçüsü	8mm
Ağırlığı	2,30 Kg
Uzunluğu	349mm
Devir	800d/dk
Hava Girişi	1/4"

Composite

Kompozit
Gövde

PUNTA ÇÜRÜTME



SM-730	\$130,90
Punta Mat. Ölçüsü	8mm
Ağırlığı	1,50 Kg
Uzunluğu	274mm
Devir	500d/dk
Hava Girişi	1/4"

KALIPÇI TAŞLAMA

	SM-532	SM-512	SM-512K
	\$36,30	\$36,30	\$48,40
Pens Ölçüsü	6mm	6mm	SET
Ağırlığı	0,40 Kg	0,50 Kg	10 adet muhtelif
Uzunluğu	152mm	172mm	Saplı taş
Devir	25000d/dk	22000d/dk	3-6mm Pens
Egzost	Arkadan	Arkadan	Rakor
Hava Girişi	1/4"	1/4"	



KALIPÇI TAŞLAMA

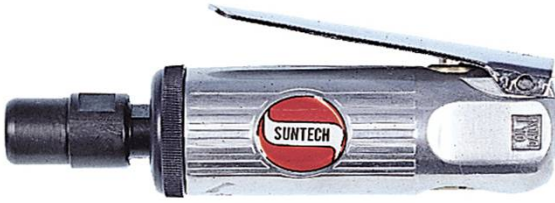

SM-552	\$36,30
Pens Ölçüsü	6mm
Ağırlığı	0,45 Kg
Uzunluğu	121mm
Devir	25000d/dk
Egzost	Önden
Hava Girişi	1/4"

KALIPÇI TAŞLAMA



SM-501C	\$48,40
Pens Ölçüsü	6mm
Ağırlığı	0,60 Kg
Uzunluğu	165mm
Devir	22000d/dk
Egzost	Önden
Hava Girişi	1/4"

KALIPÇI TAŞLAMA



SM-545	\$108,90
Pens Ölçüsü	6mm
Ağırlığı	0,65 Kg
Uzunluğu	204mm
Devir	4500d/dk
Egzost	Arkadan
Hava Girişi	1/4"

KALIPÇI TAŞLAMA



SM-572P	\$85,80
Pens Ölçüsü	6mm
Ağırlığı	0,50 Kg
Uzunluğu	170mm
Devir	22000d/dk
Egzost	Arkadan
Hava Girişi	1/4"

Composite

Kompozit
Gövde
Düşük ses

KALIPÇI TAŞLAMA



SM-51-3011B	\$85,80
Pens Ölçüsü	6mm
Ağırlığı	0,70 Kg
Uzunluğu	188mm
Devir	20000d/dk
Egzost	Arkadan
Hava Girişi	1/4"

Composite

Kompozit
Gövde
Düşük ses

KALIPÇI TAŞLAMA



SM-50-5200	\$132,00
Pens Ölçüsü	6mm
Ağırlığı	0,80 Kg
Uzunluğu	200mm
Devir	22000d/dk
Egzost	Arkadan
Hava Girişi	1/4"

Composite

Kompozit
Gövde
Düşük ses

KALIPÇI TAŞLAMA

SM-51-5100	\$77,00
Pens Ölçüsü	6mm
Ağırlığı	0,70 Kg
Uzunluğu	190mm
Devir	2000d/dk
Egzost	Arkadan
Hava Girişi	1/4"

Composite

Kompozit
Gövde
Düşük ses



KALIPÇI TAŞLAMA



SM-575P	\$96,80
Pens Ölçüsü	6mm
Ağırlığı	0,60 Kg
Uzunluğu	210mm
Devir	4500d/dk
Egzost	Arkadan
Hava Girişi	1/4"

Composite

Kompozit
Gövde
Düşük ses

KALIPÇI TAŞLAMA



SM-53-5530	\$90,80
Pens Ölçüsü	6mm
Ağırlığı	0,73 Kg
Uzunluğu	180mm
Devir	32000d/dk
Egzost	Yandan,hareketli
Hava Girişi	1/4"

Composite

Çelik
Gövde
Endüstriyel
Tip

KALIPÇI TAŞLAMA

SM-5001	\$220,00
Pens Ölçüsü	6mm
Ağırlığı	1,30 Kg
Uzunluğu	317,5mm
Devir	12000d/dk
Egzost	Arkadan
Hava Girişi	1/4"



KALIPÇI TAŞLAMA

	SM-532E	SM-512F
	\$80,30	\$83,60
Pens Ölçüsü	6mm	6mm
Ağırlığı	0,90 Kg	1,20 Kg
Uzunluğu	248mm	335mm
Devir	25000d/dk	22000d/dk
Egzost	Arkadan	Arkadan
Hava Girişi	1/4"	1/4"

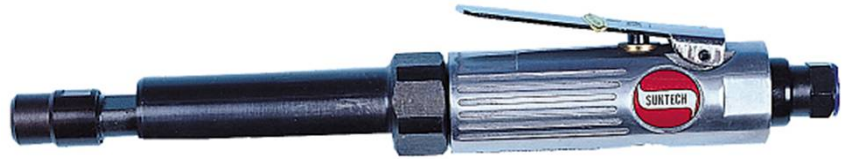

KALIPÇI TAŞLAMA

	SM-5E-5227	SM-572FP
	\$89,70	\$90,80
Pens Ölçüsü	6mm	6mm
Ağırlığı	0,90 Kg	1,20 Kg
Uzunluğu	251mm	330mm
Devir	25000d/dk	22000d/dk
Egzost	Arkadan	Arkadan
Hava Girişi	1/4"	1/4"



Kompozit
Gövde
Düşük ses

Composite

90° KALIPÇI TAŞLAMA



SM-522	\$71,50
Pens Ölçüsü	6mm
Ağırlığı	0,45 Kg
Uzunluğu	160mm
Devir	22000d/dk
Egzost	Arkadan
Hava Girişi	1/4"

90
Derece

90° KALIPÇI TAŞLAMA



SM-52-5227	\$101,80
Pens Ölçüsü	6mm
Ağırlığı	0,60 Kg
Uzunluğu	170mm
Devir	20000d/dk
Egzost	Arkadan
Hava Girişi	1/4"

Composite

90
Derece
Kompozit
Gövde
Düşük ses

115° KALIPÇI TAŞLAMA



SM-55-5227	\$101,80
Pens Ölçüsü	6mm
Ağırlığı	0,70 Kg
Uzunluğu	200mm
Devir	20000d/dk
Egzost	Arkadan
Hava Girişi	1/4"

Composite

115
Derece
Kompozit
Gövde
Düşük ses

KALEM TİP KALIPÇI TAŞLAMA



SG-0582	\$231,00
Pens Ölçüsü	3mm
Ağırlığı	0,20 Kg
Uzunluğu	133mm
Devir	82000d/dk
Egzost	Arkadan
Hava Girişi	1/4"

Kalem
Tip

KALEM TİP KALIPÇI TAŞLAMA



SM-516	\$115,00
Pens Ölçüsü	3mm
Ağırlığı	0,15 Kg
Uzunluğu	134mm
Devir	54000d/dk
Egzost	Arkadan
Hava Girişi	1/4"

Kalem
Tip

KALEM TİP KALIPÇI TAŞLAMA



SM-53-5522	\$453,80
Pens Ölçüsü	6mm
Ağırlığı	0,57 Kg
Uzunluğu	200mm
Devir	35000d/dk
Egzost	Arkadan
Hava Girişi	1/4"

Composite

Kompozit
Gövde
Düşük ses
Kalem
Tip
Endüstriyel
Tip

LASTİK TAŞLAMA



SM-661	\$96,80
Uç Tipi	Şipşaklı
Ağırlığı	0,60 Kg
Uzunluğu	216mm
Devir	2600d/dk
Egzost	Arkadan
Hava Girişi	1/4"

LASTİK TAŞLAMA



SM-662	\$96,80
Uç Tipi	Taşlı
Ağırlığı	0,60 Kg
Uzunluğu	222mm
Devir	2500d/dk
Egzost	Arkadan
Hava Girişi	1/4"

LASTİK TAŞLAMA



SM-747	\$108,90
Uç Tipi	Şipşaklı
Ağırlığı	1,20 Kg
Uzunluğu	838mm
Devir	4500d/dk
Egzost	Arkadan
Hava Girişi	1/4"

LASTİK TAŞLAMA



SM-671P	\$106,70
Uç Tipi	Şipşaklı
Ağırlığı	0,90 Kg
Uzunluğu	215mm
Devir	2600d/dk
Egzost	Arkadan
Hava Girişi	1/4"

Composite

Kompozit
Gövde
Düşük ses

50mm SATIŞ TAŞLAMA



SM-6542	\$141,90
Taş Çapı	50mm
Diş Ölçüsü	3/8"x24UNF
Ağırlığı	0,60 Kg
Uzunluğu	133mm
Devir	20000d/dk
Hava Girişi	1/4"

Composite

Kompozit
Gövde
Düşük ses

50mm SATIŞ TAŞLAMA



SM-5J-5423K	\$174,40
Taş Çapı	50mm
Diş Ölçüsü	3/8"x24UNF
Ağırlığı	0,60 Kg
Uzunluğu	133mm
Devir	20000d/dk
Hava Girişi	1/4"

Composite

Kompozit
Gövde
Düşük ses

100mm SATIH TAŞLAMA



SG-0502	\$47,30
Taş Çapı	100mm
Diş Ölçüsü	7/16"x20UNF
Ağırlığı	1,35 Kg
Uzunluğu	152mm
Devir	18000d/dk
Hava Girişi	1/4"

100mm SATIH TAŞLAMA



SG-0520	\$150,20
Taş Çapı	100mm
Diş Ölçüsü	3/8"x24UNF
Ağırlığı	1,50 Kg
Uzunluğu	222mm
Devir	11000d/dk
Hava Girişi	1/4"

Düşük ses

125mm SATIH TAŞLAMA



SG-0519-5	\$150,20
Taş Çapı	125mm
Diş Ölçüsü	m10x1,5 /m14x2
Ağırlığı	1,90 Kg
Uzunluğu	228mm
Devir	11000d/dk
Hava Girişi	1/4"

125mm SATIH TAŞLAMA



SM-5D-6192PS/M14	\$199,70
Taş Çapı	125mm
Diş Ölçüsü	m14x2
Ağırlığı	2,00 Kg
Uzunluğu	238mm
Devir	10000d/dk
Hava Girişi	1/4"

Composite

Kompozit
Gövde
Düşük ses

125mm SATIH TAŞLAMA



SM-5D-6401R	\$217,80
Taş Çapı	125mm
Diş Ölçüsü	m14x2
Ağırlığı	1,54 Kg
Uzunluğu	210mm
Devir	12000d/dk
Hava Girişi	1/4"

Composite

Kompozit
Gövde
Düşük ses

180mm SATIH TAŞLAMA



	SM-5G-6197M14	SM-5G-6197/58
	\$242,00	\$242,00
Taş Çapı	180mm	180mm
Diş Ölçüsü	m14x2	5/8x11BSW
Ağırlığı	3,50 Kg	3,50 Kg
Uzunluğu	350mm	350mm
Devir	7000d/dk	7000d/dk
Hava Girişi	3/8"	3/8"

180mm SATIH TAŞLAMA



SM-5G-6413	\$583,00
Taş Çapı	180mm
Diş Ölçüsü	5/8x11BSW
Ağırlığı	3,00 Kg
Uzunluğu	323mm
Devir	8400d/dk
Güç	2,2hp
Hava Girişi	3/8"

180mm SATIH TAŞLAMA



SM-5G-6413R	\$583,00
Taş Çapı	180mm
Diş Ölçüsü	5/8x11BSW
Ağırlığı	3,00 Kg
Uzunluğu	277mm
Devir	8400d/dk
Güç	2,2hp
Hava Girişi	3/8"

180mm SATIH TAŞLAMA

SM-5G-421V	\$632,50
Taş Çapı	180mm
Diş Ölçüsü	5/8x11BSW
Ağırlığı	5,30 Kg
Uzunluğu	295mm
Devir	6000d/dk
Güç	4hp
Hava Girişi	1/2"



230mm SATIH TAŞLAMA



SM-5H-400V	\$632,50
Taş Çapı	230mm
Diş Ölçüsü	5/8x11BSW
Ağırlığı	5,50 Kg
Uzunluğu	337mm
Devir	6000d/dk
Güç	4 hp
Hava Girişi	1/2"

230mm SATIH TAŞLAMA



SM-5H-421V	\$632,50
Taş Çapı	230mm
Diş Ölçüsü	5/8x11BSW
Ağırlığı	5,60 Kg
Uzunluğu	332mm
Devir	6000d/dk
Güç	4 hp
Hava Girişi	1/2"

75mm YATAY TİP SATIŞ TAŞLAMA



SG-0523	\$338,00
Taş Çapı	75mm
Diş Ölçüsü	3/8"x24UNF
Ağırlığı	0,65 Kg
Uzunluğu	425mm
Devir	7000d/dk
Hava Girişi	1/4"

100mm UZUN TİP SATIŞ TAŞLAMA VE KESME



SM-5L-3011B	\$189,20
Taş Çapı	100mm
Ağırlığı	1,40 Kg
Uzunluğu	304mm
Devir	17000d/dk
Hava Girişi	1/4"

Composite

Kompozit
Gövde
Düşük ses

POLİSAJ



	SG-0472	SM-6N-6661M14
	\$139,20	\$199,70
Disk Çapı	180mm	180mm
Diş Ölçüsü	5/8x11BSW	m14x2
Ağırlığı	2,25 Kg	2,00 Kg
Uzunluğu	406mm	307mm
Devir	2500d/dk	2500d/dk
Hava Girişi	1/4"	1/4"

DAİRESEL ZIMPARA



	SG-0470	SM-67-6661M14
	\$133,10	\$193,60
Disk Çapı	180mm	180mm
Diş Ölçüsü	5/8x11BSW	m14x2
Ağırlığı	2,25 Kg	2,00 Kg
Uzunluğu	406mm	307mm
Devir	4500d/dk	4500d/dk
Hava Girişi	1/4"	1/4"

POLİSAJ



SM-6004K	\$178,20
Disk Çapı	75mm
Ağırlığı	0,90 Kg
Uzunluğu	127mm
Devir	2500d/dk
Hava Girişi	1/4"

DAİRESEL ZIMPARA

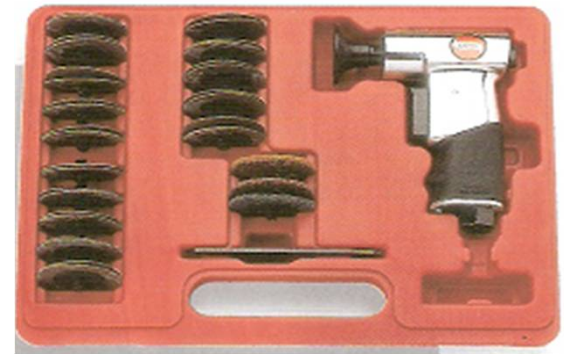

	SM-6001-2K	SM-6001-3K
	\$237,60	\$237,60
Disk Çapı	50mm	75mm
Diş Ölçüsü	1/4"x20BSW	1/4"x20BSW
Ağırlığı	0,80 Kg	0,80 Kg
Uzunluğu	117mm	117mm
Devir	15000d/dk	15000d/dk
Hava Girişi	1/4"	1/4"

DAİRESEL ZIMPARA



SM-60-8020	\$121,00
Disk Çapı	75-115-140mm
Ağırlığı	1,00 Kg
Uzunluğu	142mm
Devir	16000d/dk
Hava Girişi	1/4"

Sağ-Sol

DAİRESEL ZIMPARA



SM-60-8130	\$121,00
Disk Çapı	75-125-140mm
Ağırlığı	1,00 Kg
Uzunluğu	134mm
Devir	16000d/dk
Hava Girişi	1/4"

Sağ-Sol

DAİRESEL ZIMPARA



SM-572	\$283,30
Disk Çapı	30mm
Ağırlığı	0,22 Kg
Uzunluğu	158mm
Devir	22000d/dk
Hava Girişi	1/4"

SULU TİP DAİRESEL ZIMPARA



SM-615	\$432,30
Disk Çapı	150mm
Diş Ölçüsü	5/8"x11BSW
Ağırlığı	2,25 Kg
Uzunluğu	198mm
Devir	1000d/dk
Hava Girişi	1/4"

Sulu Tip

EKSANTRİK DAİRESEL ZIMPARA

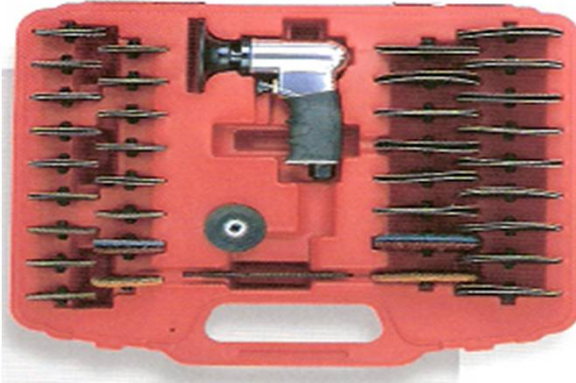

SM-72831K	\$237,60
Disk Çapı / Ekst.	75mm/ 3mm
Diş Ölçüsü	1/4"x20BSW
Ağırlığı	0,70 Kg
Uzunluğu	109mm
Devir	15000d/dk
Hava Girişi	1/4"

Tetikten
Hız
Ayarlı

EKSANTRİK DAİRESEL ZIMPARA

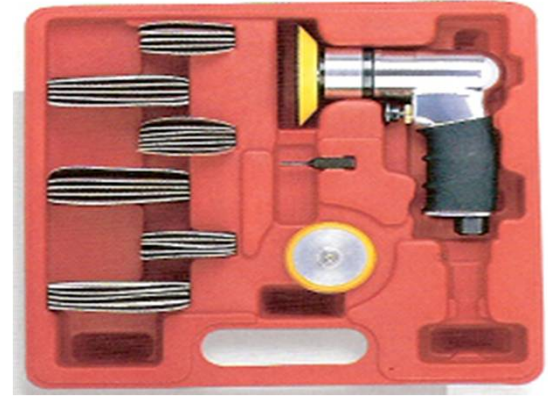

SM-72833K	\$178,20
Disk Çapı / Ekst.	75mm/ 3mm
Diş Ölçüsü	m6x1
Ağırlığı	0,70 Kg
Uzunluğu	117mm
Devir	15000d/dk
Hava Girişi	1/4"

EKSANTRİK DAİRESEL ZIMPARA



SM-6003VK	\$178,20
Disk Çapı / Ekst.	75mm/ 3mm
Diş Ölçüsü	1/4"x20BSW
Ağırlığı	0,80 Kg
Uzunluğu	113mm
Devir	15000d/dk
Hava Girişi	1/4"

EKSANTRİK DAİRESEL ZIMPARA



SG-0420	\$61,60
Disk Çapı / Ekst.	150mm/ 5mm
Diş Ölçüsü	5/16"x24UNF
Ağırlığı	1,70 Kg
Uzunluğu	222mm
Devir	10000d/dk
Hava Girişi	1/4"

EKSANTRİK DAİRESEL ZIMPARA



SG-9604V	\$214,50
Disk Çapı / Ekst.	150mm/ 5mm
Diş Ölçüsü	5/16"x24UNF
Ağırlığı	2,70 Kg
Uzunluğu	266mm
Devir	7000d/dk
Hava Girişi	1/4"

EKSANTRİK DAİRESEL ZIMPARA



SG-0414	\$127,10
Disk Çapı / Ekst.	200mm/ 5mm
Ağırlığı	2,00 Kg
Uzunluğu	292mm
Devir	3500d/dk
Hava Girişi	1/4"

EKSANTRİK DAİRESEL ZIMPARA



	SM-603	SM-603V
	\$169,40	\$217,80
Disk Çapı / Ekst.	150mm/ 5mm	150mm/ 5mm
Diş Ölçüsü	5/16"x24UNF	5/16"x24UNF
Ağırlığı	1,35 Kg	1,80 Kg
Uzunluğu	152mm	152mm
Devir	10000d/dk	10000d/dk
Hava Girişi	1/4"	1/4"



EKSANTRİK DAİRESEL ZIMPARA



	SM-66-6133	Toz Emişli SM-66-6133A
	\$181,50	\$290,40
Disk Çapı / Ekst.	150mm/ 5mm	150mm/ 5mm
Diş Ölçüsü	5/16"x24UNF	5/16"x24UNF
Ağırlığı	0,76 Kg	0,78 Kg
Uzunluğu	163-213mm	163-213mm
Devir	11000d/dk	11000d/dk
Hava Girişi	1/4"	1/4"

Composite

Kompozit
Gövde
Düşük ses

EKSANTRİK DAİRESEL ZIMPARA



	SM-66-6132	Toz Emişli SM-66-6132A
	\$181,50	\$290,40
Disk Çapı / Ekst.	150mm/ 5mm	150mm/ 5mm
Diş Ölçüsü	5/16"x24UNF	5/16"x24UNF
Ağırlığı	1,00 Kg	1,00 Kg
Uzunluğu	268mm	268mm
Devir	10000d/dk	10000d/dk
Hava Girişi	1/4"	1/4"

Composite

Kompozit
Gövde
Düşük ses

EKSANTRİK DAİRESEL ZIMPARA



	Toz Emişli
SM-66-6133C	\$266,20
Disk Çapı / Ekst.	150mm/ 5mm
Diş Ölçüsü	5/16"x24UNF
Ağırlığı	0,78 Kg
Uzunluğu	213mm
Devir	11000d/dk
Hava Girişi	1/4"

Composite

Kompozit
Gövde
Düşük ses

EKSANTRİK DAİRESEL ZIMPARA



	SM-640	\$174,40
Disk Çapı / Ekst.	125mm / 5mm	
Ağırlığı	1,00 Kg	
Uzunluğu	168mm	
Devir	9000d/dk	
Hava Girişi	1/4"	

RENDE ZIMPARA



SG-0430	\$138,10
Taban Ölçüsü	70x440mm
Strok	25mm
Ağırlığı	2,80 Kg
Uzunluğu	406mm
Devir	3000d/dk
Hava Girişi	1/4"

EKSANTRİK TİTREŞİMLİ ZIMPARA

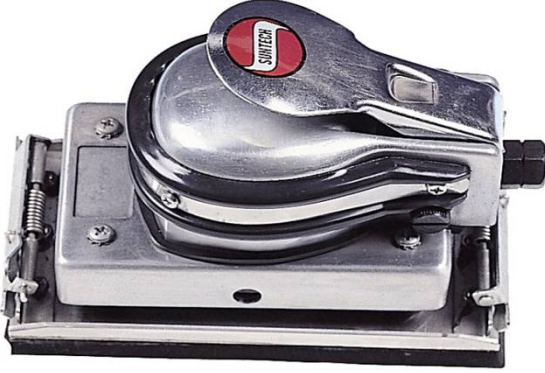

SG-0416	\$54,50
Taban Ölçüsü	95x165mm
Eksantrik	5mm
Ağırlığı	1,80 Kg
Uzunluğu	188mm
Devir	8000d/dk
Hava Girişi	1/4"

EKSANTRİK TİTREŞİMLİ ZIMPARA



SM-650	Toz Emişli	\$189,20
Taban Ölçüsü	75x150mm	
Eksantrik	5mm	
Ağırlığı	1,20 Kg	
Uzunluğu	160mm	
Devir	8000d/dk	
Hava Girişi	1/4"	

EKSANTRİK TİTREŞİMLİ ZIMPARA



SM-6205D	Toz Emişli	\$357,00
Taban Ölçüsü	112x220mm	
Strok	5mm	
Ağırlığı	2,30 Kg	
Uzunluğu	284mm	
Devir	6500d/dk	
Hava Girişi	1/4"	

EKSANTRİK TİTREŞİMLİ KÖŞE ZIMPARA



SM-519S	\$236,00
Disk Çapı	75mm
Ağırlığı	1,20 Kg
Uzunluğu	585mm
Devir	20000d/dk
Hava Girişi	1/4"

BANT ZIMPARA

Düşük ses

	SM-6T-6200	SM-6X-6300
	\$290,40	\$428,50

Bant Ölçüsü	20x520mm	30x540mm
Ağırlığı	1,40 Kg	2,20 Kg
Uzunluğu	395mm	400mm
Devir	16000d/dk	12000d/dk
Hava Girişi	1/4"	1/4"

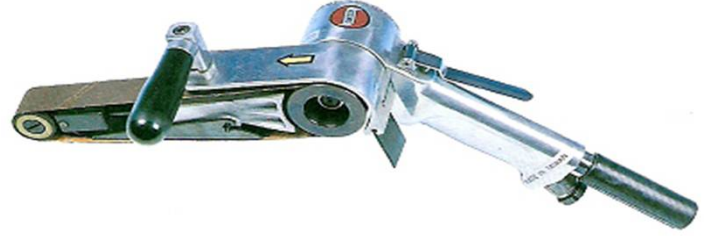
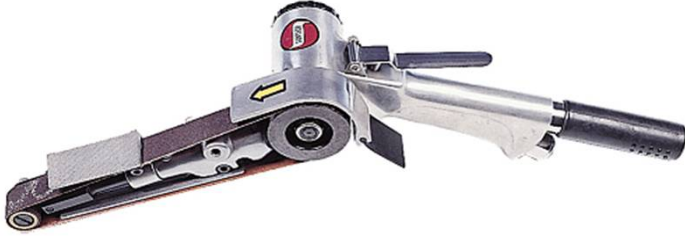

	SM-610	SM-612	SM-620	SM-630
	\$140,80	\$181,50	\$187,00	\$316,80

Bant Ölçüsü	10x330mm	13x610mm	20x520mm	30x540mm
Ağırlığı	0,80 Kg	0,80 Kg	1,40 Kg	2,20 Kg
Uzunluğu	260mm	600mm	300mm	290mm
Devir	16000d/dk	16000d/dk	16000d/dk	12000d/dk
Hava Girişi	1/4"	1/4"	1/4"	1/4"

BANT ZIMPARA SETİ

	SM-6Z-6104K	SM-6Z-6201K
	\$258,50	\$281,60

Bant Ölçüsü	6-13mm	6-10-13-20mm
Ağırlığı	1,00 Kg	2,90 Kg
Uzunluğu	307mm	390mm
Devir	20000d/dk	18000d/dk
Hava Girişi	1/4"	1/4"
Set Muhteviyatı	3 adet Kafa ve Bant zımparalar	5 adet Kafa ve Bant zımparalar



YÜZEY TEMİZLEME



SM-6902	SM-6902K
\$323,40	\$437,80

Ağırlığı	1,50 Kg	SET
Uzunluğu	305mm	11 parça
Devir	3500d/dk	Telleri,Silgileri
Hava Girişi	1/4"	ve göbekleri ile

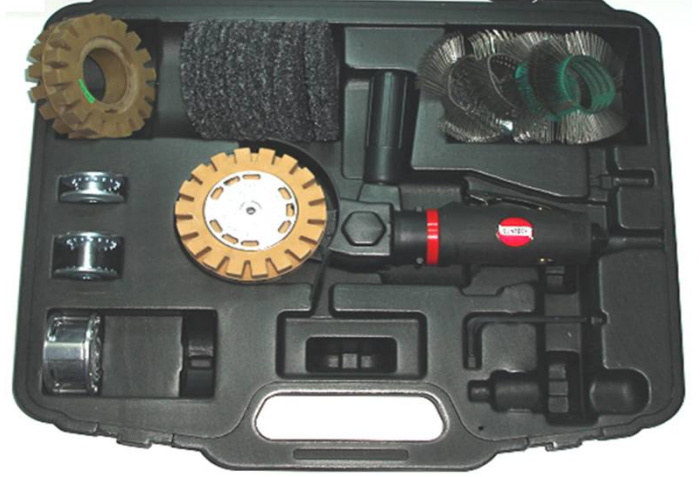

YÜZEY TEMİZLEME

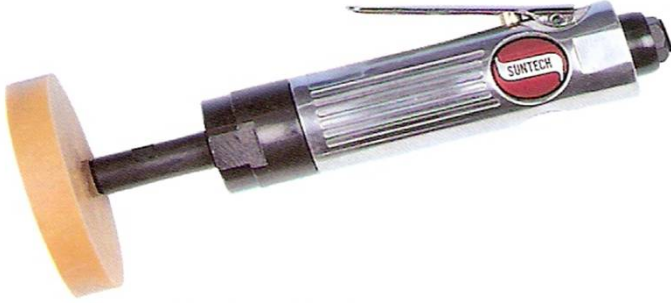

SM-645	\$110,00
Disk Çapı	90mm
Ağırlığı	0,76 Kg
Uzunluğu	221mm
Devir	4000d/dk
Egzost	Arkadan
Hava Girişi	1/4"

YÜZEY TEMİZLEME



SM-6K-3011B	\$127,10
Disk Çapı	90mm
Ağırlığı	0,95 Kg
Uzunluğu	226mm
Devir	4000d/dk
Egzost	Arkadan
Hava Girişi	1/4"

Composite

Kompozit
Gövde
Düşük ses

SOMUNLU PERÇİN MAKİNESİ



SM-HN-6000C	\$1.633,50
Kapasitesi	m4-5-6-8-12
Ağırlığı	2,95 Kg
Hava Girişi	1/4"

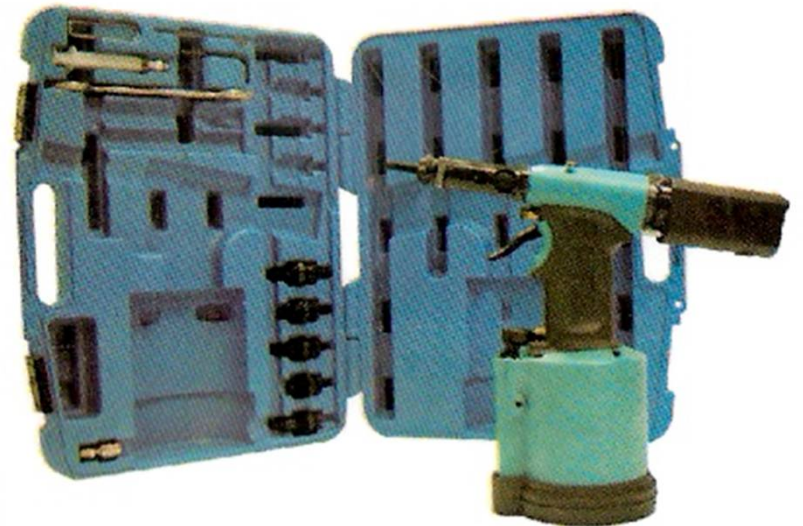

POP PERÇİN MAKİNESİ



SG-0810	SG-0810K
\$93,50	\$126,50

Kapasitesi	5mm	SET
Ağırlığı	2,00 Kg	Memeleri ve
Uzunluğu	292mm	Tamir Takımları
Hava Girişi	1/4"	İle Birlikte

AĞIR TIP POP PERÇİN MAKİNESİ



SG-0814	\$356,40
Kapasitesi	6mm
Ağırlığı	2,10 Kg
Uzunluğu	320mm
Hava Girişi	1/4"

Ağır
Hizmet

TESTERE

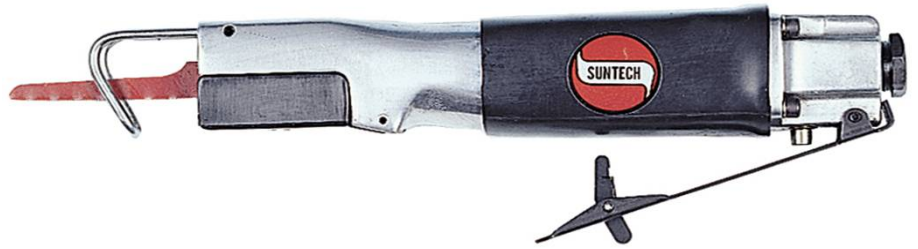

SG-0822	\$94,60
Kesme Kapasitesi	1,6mm
Ağırlığı	0,60 Kg
Uzunluğu	235mm
Devir	9000d/dk
Egzost	1/4"

TESTERE



SG-0827	\$141,90
Kesme Kapasitesi	1,6mm
Ağırlığı	0,90 Kg
Uzunluğu	1000mm
Devir	8000d/dk
Egzost	1/4"

Arkadan
Egzostlu

EĞE

SG-0825	\$130,90
Piston Stroku	9mm
Ağırlığı	1,00 Kg
Uzunluğu	178mm
Hava Girişi	1/4"



NİBLİNG TIPI MAKAS



SG-0821	\$84,70
Kesme Kapasitesi	1,2mm (Çelik)
Ağırlığı	1,15 Kg
Uzunluğu	203mm
Hava Girişi	1/4"

SAC MAKASI



SM-204	\$96,80
Kesme Kapasitesi	1,8mm (Çelik)
Devir	2600d/dk
Ağırlığı	2,25 Kg
Uzunluğu	210mm
Hava Girişi	1/4"

SAC MAKASI

SM-204S	\$96,80
Kesme Kapasitesi	1,8mm (Çelik)
Devir	2600d/dk
Ağırlığı	1,00 Kg
Uzunluğu	255mm
Hava Girişi	1/4"

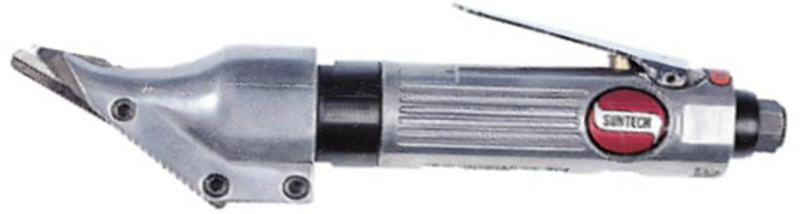

AVUÇ İÇİ ÇİVİ ÇAKMA



SG-0125	\$156,20
Kapasitesi	10mm
Boy	125mm
Ağırlığı	1,35 Kg
Hava Girişi	1/4"

AVUÇ İÇİ ÇEKİÇ



SG-0126	\$156,20
Boy	125mm
Ağırlığı	1,35 Kg
Hava Girişi	1/4"

SAC KIVIRMA VE PUNTA

	SG-0692	SG-0693
	\$100,70	\$134,20
Kapasitesi	5mm	8mm
Ağırlığı	1,90 Kg	1,90 Kg
Uzunluğu	255mm	255mm
Hava Girişi	1/4"	1/4"



YAN KESKİ

	SG-0823	SG-0824
	\$108,90	\$115,00
Kapasitesi	0,5mm-Çelik 1,0mm-Bakır 2,0mm-Plastik	1,0mm-Çelik 1,6mm-Bakır 4,0mm-Plastik
Ağırlığı	0,14 Kg	0,24 Kg
Uzunluğu	100mm	124mm
Hava Girişi	1/4"	1/4"



VAKUMLU (KAPORTA) ÇEKTİRME

SM-202	\$211,80
Taban lastik çapı	120mm+150mm
Çekiç ağırlığı	1,40 Kg
Uzunluğu	600mm
Hava Girişi	1/4"



FİBER KESİCİ



SM-526	\$48,40
Disk Çapı	75mm
Devir	20000d/dk
Ağırlığı	0,90 Kg
Uzunluğu	203mm
Hava Girişi	1/4"

FİBER KESİCİ



SM-5265R	\$72,60
Disk Çapı	75mm
Devir	18000d/dk
Ağırlığı	0,90 Kg
Uzunluğu	195mm
Hava Girişi	1/4"

Kompozit
Gövde
Düşük ses

CAM FİTİLİ (SİLİKONU) KESME

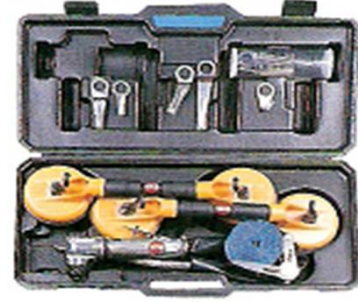

	SM-518	SM-518K
	\$132,00	\$437,80

Hareket say./Strok	20000d/dk/75mm	SM-518,1 Adet
Ağırlığı	1,00 Kg	Bıçak,2 Adet
Uzunluğu	193mm	2'li Vantuz,1 Adet
Hava Girişi	1/4"	Taşıma Kayışı

DARBELİ YAZI YAZMA



SG-0573	\$143,00
Vuruş Adedi	3800bpm
Ağırlığı	0,20 Kg
Uzunluğu	171mm
Hava Girişi	1/4"

DARBELİ YAZI YAZMA



SM-10-1001K	\$363,00
Uç Ölçüsü	1/8"
Vuruş Adedi	13500bpm
Piston Stroku	8,2mm
Piston Çapı	5,8mm
Ağırlığı	0,14 Kg
Uzunluğu	122mm
Hava Girişi	1/4"

HAVŞA AÇMA

SM-205	\$220,00
Devir	20000d/dk
Ağırlığı	1,80 Kg
Uzunluğu	228mm
Hava Girişi	1/4"

6 Adet
Ucuyla
7'Li set

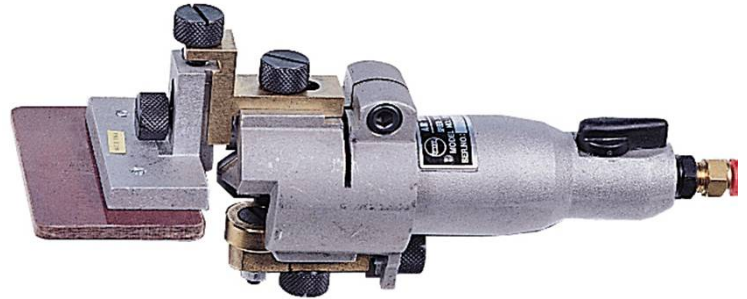

ISKARPELA

SG-0815	\$61,60
Vuruş sayısı	4500d/dk
Piston Stroku	57mm
Ağırlığı	0,68 Kg
Uzunluğu	248mm
Hava Girişi	1/4"



ÇEKİÇ-KESKİ

4 Adet Ucuyla Karton Kutuda	SG-0101R/H	SG-0204R/H
	\$44,00	\$75,90
Uç Giriş Çapı	10,4mm	10,4mm
Piston Stroku	41mm	64mm
Vuruş Adedi	5000bpm	3200bpm
Ağırlığı	1,35 Kg	1,58 Kg
Uzunluğu	134mm	172mm
Hava Girişi	1/4"	1/4"



ÇEKİÇ-KESKİ

5 Adet Ucuyla Plastik Kutuda	SG-0204PSR	SG-0304PSR
	\$82,50	\$192,50
Uç Giriş Çapı	10,4mm	10,4mm
Piston Stroku	64mm	89mm
Vuruş Adedi	3200bpm	2000bpm
Ağırlığı	1,58 Kg	1,80 Kg
Uzunluğu	172mm	228mm
Hava Girişi	1/4"	1/4"

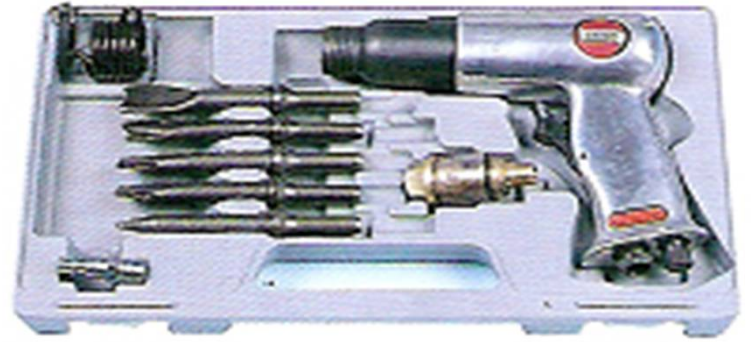

ÇEKİÇ-KESKİ-İĞNELİ KESKİ

SG-0204RNS	\$152,90
Vuruş Adedi	3200bpm
Ağırlığı	2,16 Kg
Uzunluğu	343mm
İğne çapı/Adedi	3mm/ 19 adet
Hava Girişi	1/4"



ÇEKİÇ-KESKİ

SG-2288	\$96,80
Vuruş Adedi	4000bpm
Ağırlığı	0,90 Kg
Uzunluğu	280mm
Hava Girişi	1/4"



ÇEKİÇ-KESKİ-İĞNELİ KESKİ

SG-2288NS	\$112,80
Vuruş Adedi	4000bpm
Ağırlığı	1,20 Kg
Uzunluğu	290mm
İğne çapı/Adedi	3mm/12 adet.
Hava Girişi	1/4"



ÇEKİÇ-KESKİ

SG-0315	\$152,90
Vuruş Adedi	4000bpm
Ağırlığı	1,58 Kg
Uzunluğu	406mm
Hava Girişi	1/4"



ÇEKİÇ-KESKİ-İĞNELİ KESKİ

SG-0315NS	\$221,70
Vuruş Adedi	4000bpm
Ağırlığı	2,60 Kg
Uzunluğu	416mm
İğne çapı/Adedi	3mm/ 19 adet
Hava Girişi	1/4"



ÇEKİÇ-KESKİ

SG-9121	\$130,90
Vuruş Adedi	4600bpm
Ağırlığı	1,35 Kg
Uzunluğu	368mm
Hava Girişi	1/4"



ÇEKİÇ-KESKİ-İĞNELİ KESKİ

SG-9121NS	\$247,50
Vuruş Adedi	4600bpm
Ağırlığı	2,50 Kg
Uzunluğu	381mm
İğne çapı/Adedi	3mm/ 19 adet
Hava Girişi	1/4"



ÇEKİÇ-KESKİ-İĞNELİ KESKİ

SG-2100NS	\$286,00
Vuruş Adedi	3000bpm
Ağırlığı	2,60 Kg
Uzunluğu	376mm
İğne çapı/Adedi	3mm/ 19 adet
Hava Girişi	1/4"



ÇEKİÇ-KESKİ-İĞNELİ KESKİ

SG-2110NS	\$178,20
Vuruş Adedi	3000bpm
Ağırlığı	2,60 Kg
Uzunluğu	315mm
İğne çapı/Adedi	3mm/ 19 adet
Hava Girişi	1/4"



ÇEKİÇ-KESKİ-İĞNELİ KESKİ

SG-2280	\$363,00
Vuruş Adedi	4500bpm
Ağırlığı	3,50 Kg
Uzunluğu	355mm
İğne çapı/Adedi	3mm/ 28 adet 4mm/ 14 adet
Hava Girişi	1/4"



ÇEKİÇ-KESKİ-İĞNELİ KESKİ

SG-2111NS	\$355,90
Vuruş Adedi	2200bpm
Ağırlığı	4,95 Kg
Uzunluğu	398mm
İğne çapı/Adedi	4mm/ 35 adet
Hava Girişi	1/4"



"S" TİPİ RASPA

SG-2200	\$126,50
Vuruş Adedi	8000bpm
Ağırlığı	1,90 Kg
Uzunluğu	115mm
Hava Girişi	1/4"



PERÇİN ÇEKİCİ



	SG-0123R	SG-0122R1	SG-0122R2	SG-0122R3	SG-0122R4
	\$209,00	\$319,00	\$396,00	\$429,00	\$453,20
Uç Giriş Çapı	20mm	28mm	28mm	28mm	28mm
Piston Stroku	64mm	25mm	50mm	75mm	100mm
Vuruş Adedi	3000bpm	2100bpm	1900bpm	1700bpm	1400bpm
Ağırlığı	2,30 Kg	6,50 Kg	6,80 Kg	7,20 Kg	8,10 Kg
Uzunluğu	241mm	368mm	394mm	413mm	464mm
Hava Girişi	1/4"	3/8"	3/8"	3/8"	3/8"
Hortum Çapı	10mm	13mm	13mm	13mm	13mm

PERÇİN ÇEKİCİ



	SM-DR100V	SM-DR200V	SM-DR300V	SM-DR400V
	\$459,80	\$484,00	\$508,20	\$526,40
Uç Giriş Çapı	28mm	28mm	28mm	28mm
Piston Stroku	64mm	76mm	95mm	108mm
Vuruş Adedi	2450bpm	2300bpm	2100bpm	1700bpm
Ağırlığı	7,30 Kg	7,70 Kg	8,40 Kg	8,90 Kg
Uzunluğu	305mm	356mm	387mm	419mm
Hava Girişi	3/8"	3/8"	3/8"	3/8"
Hortum Çapı	13mm	13mm	13mm	13mm

BETON KIRICI



	SM-P612	SM-P912
	\$1.512,50	\$1.705,00
Uç Giriş Çapı	32x152mm	32x152mm
Piston Çapı	57,15mm	66,67mm
Piston Stroku	100mm	152mm
Vuruş Adedi	1400bpm	1250bpm
Ağırlığı	30 Kg	42 Kg
Uzunluğu	645mm	723mm
Hava Girişi	3/4"	3/4"
Hortum Çapı	19mm	19mm

GRES TABANÇASI



SG-843

\$31,90

SG-843K

\$42,40

Kapasitesi	500cc	El Pompa
Hava Girişi	1/4"	Aparatı İle

KUMLAMA TABANÇASI



SG-9171

\$42,40

Hava Girişi	1/4"
-------------	------

Torbalı
Model

VAKUM VE TEMİZLİK TABANÇASI

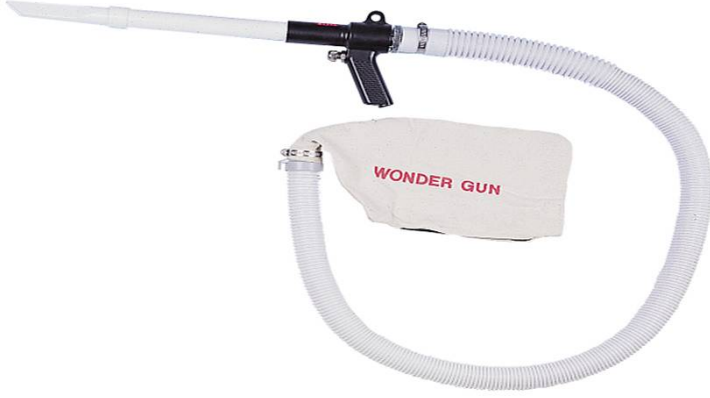

SG-1222

\$27,50

Hava Girişi	1/4"
-------------	------

SİLİKON TABANÇASI



SG-9907

\$26,40

Hava Girişi	1/4"
-------------	------

Kartuş
Silikon
İçin

BOYA TABANÇASI



SG-1048

\$126,00

Meme Ölçüsü	1,4mm
Depo	Üstten-Plastik

BOYA TABANÇASI



SG-1042

\$113,90

Meme Ölçüsü	1,5mm
Depo	Üstten-Metal

BOYA TABANÇASI



SG-1046

\$96,80

Meme Ölçüsü	1,6mm
Depo	Alttan-Metal

MOTOR YIKAMA TABANCASI



SG-1070

\$14,90

Hava Girişi

1/4"

MAZOT TABANCASI



SG-1057

\$42,40

Hava Girişi

1/4"

Metal
Depo

LASTİĞE HAVA BASMA



ST-725

\$18,20

Saatli



ST-712

\$5,00

HAVA TABANCASI



SG-1063

\$6,10

Kısa-Metal

HAVA TABANCASI



SG-1062

\$13,20

Kısa-Metal

HAVA TABANCASI



SG-1064L

\$14,90

Uzun-Metal

HAVA TABANCASI



SG-1065

\$7,70

Kısa-Plastik

HAVA TABANCASI



SG-1072

\$5,00

Kısa-Plastik

HAVA TABANCASI

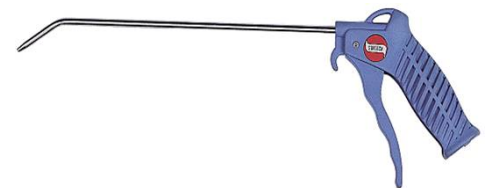

SG-1072L

\$9,90

Uzun-Plastik

CAM VANTUZU



SM-911

\$65,50

2'li Tek Vantuz

CAM VANTUZ SETİ



SM-911KNH

\$145,20

Set / 2 ad.2'li Vantuz + Taşıma Kayışı

CAM TAŞIMA KAYIŞI



SM-911NH

\$14,90

Cam Taşıma Kayışı

CAM FİTİLİ (SİLİKONU) KESME BIÇAKLARI

SA-51851

\$11,00

57mm



SA-51855

\$11,00

18mm



SA-51854

\$16,50

90mm

SA-51857

\$16,50

36mm

SA-51852

\$11,00

35mm



SA-51858

\$16,50

63mm

SA-51859

\$16,50

90mm

SA-51853

\$11,00

30mm



SA-51861

\$11,00

35mm



SA-51860

\$11,00

8mm



SA-51862

\$11,00

35mm



ŞARTLANDIRICI



SG-070012

\$77,60

Şartlandırıcı
1/2"

FİLTRE REGÜLATÖR



SB-2041

\$66,60

Filtre Regülatör
1/2"

FİLTRE



SB-1141

\$24,20

Filtre
1/2"

REGÜLATÖR



SB-1241

\$30,30

Regülatör
1/2"

YAĞLAYICI



SB-1341

\$24,20

Yağlayıcı
1/2"

YÜZEY TEMİZLEME TELİ

SA-0511

\$14,30

Düz Tel 11mm

SA-0523

\$14,30

Düz Tel 23mm

SA-0711

\$14,30

Eğri Tel 11mm

SA-0723

\$14,30

Eğri Tel 23mm



YÜZEY TEMİZLEME TELİ GÖBEK ADAPTÖRÜ

SA-6902WH

\$18,60

Adaptör 11mm

SA-6902RH

\$18,60

Adaptör 23mm



YÜZEY TEMİZLEME SİLGİSİ



SA-6902RW

\$22,00

YÜZEY TEMİZLEME SÜNGERİ



SA-6902BW

\$7,70

MINİ FİLTRE

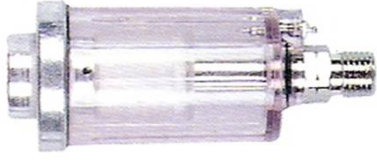

G-302

\$9,40

1/4"

MINİ REGÜLATÖR

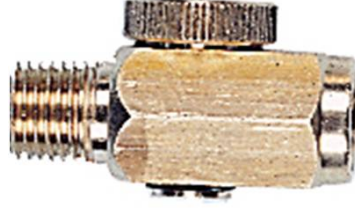

SG-9052

\$5,00

1/4"

MINİ YAĞLAYICI



G-301

\$9,40

1/4"

HAVALI KESKİ YEDEĞİ



SG-1304R/H

\$6,50

4'lü

SG-1306R/H

\$20,90

6'li

HAVALI KESKİ TUTUCU
KAFASI



G-102

\$12,10

HAVALI KESKİ TUTUCU
YAYI



SA-0101S

\$6,60

KALIPÇI TAŞLAMA PENSİ



\$5,00

3-6mm

HAVALI YAN KESKİ YEDEĞİ



S-2
(SG-0823)

\$72,60

S-4
(SG-0824)

\$78,70

SAC KESME YEDEK KAFASI



SA-204/204S

\$48,40

EĞE YEDEĞİ



SA-0825S

\$29,20

4'lü Takım

TESTERE YEDEĞİ



SA-24S/32S

\$2,20

LASTİK TAŞLAMA
ŞİPŞAK KAFASI



SA-0661

\$24,20

KÖŞE ZIMPARA YEDEĞİ



SA-518

\$34,10

İSTİNAT (ZIMPARA) DİSKİ



\$7,70

115mm

ZIMPARA TABANI

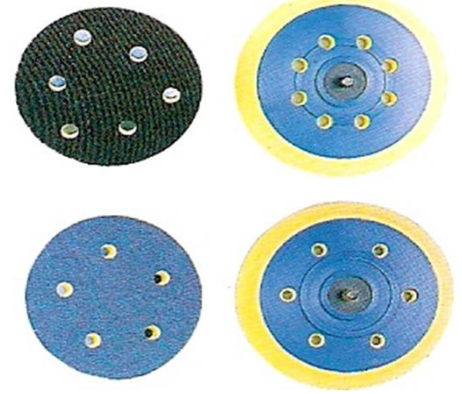

CİRTLİ

\$8,80

150mm
6 Delikli

YAPIŞKANLI

\$7,70

150mm
6 Delikli

MAFSALLI RAKOR



SA-14/38

\$13,20

1/4" ve 3/8"

RASPA İĞNESİ

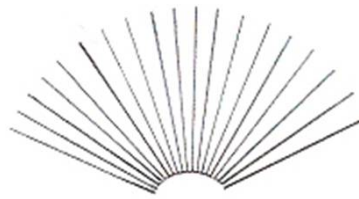

N.307-3

\$0,70

3mm

N.307-4

\$0,70

4mm

PUNTA ÇÜRÜTME UCU



SA-72151-5

\$14,90

5mm

SA-72151-6

\$14,90

6mm

SA-72151-8

\$14,90

8mm

HAVA REELLERİ

HR-600

\$76,50

Hortum ölçüsü 6,50 x 9,50mm
Hortum boyu 6mt

HR-750

\$76,50

Hortum ölçüsü 5,00 x 8,00mm
Hortum boyu 7,50mt

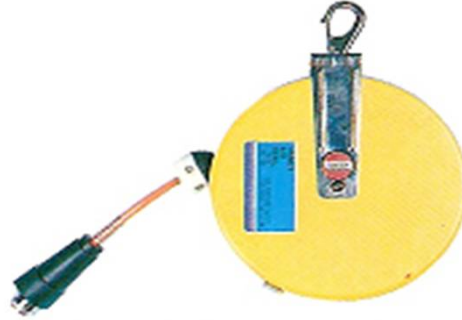

SPIRAL HORTUMLAR

POLIÜRETAN

SA-225PU

\$5,50

SA-250PU

\$9,90

SA-325PU

\$8,80

SA-350PU

\$16,50

SA-807PU

\$12,10

SA-812PU

\$23,10

Hortum Ölçüsü 5x8mm 7,5mt 5x8mm 15mt 6,5x9,5mm 7,5mt 6,5x9,5mm 15mt 8x12mm 7,5mt 8x12mm 15mt

POLIÜRETAN

Kaplinli
SA-225PUK

\$13,20

Kaplinli
SA-250PUK

\$17,60

Kaplinli
SA-325PUK

\$16,50

Kaplinli
SA-350PUK

\$24,20

Hortum Ölçüsü 5x8mm 7,5mt 5x8mm 15mt 6,5x9,5mm 7,5mt 6,5x9,5mm 15mt

PVC

SA-250

\$10,20

Hortum Ölçüsü 5x8mm 15mt



YAYLI BALANSERLER



SB-1,5K	\$46,20
Kapasite	0,50-1,00 Kg
Halat Boyu	130cm



SB-22K	\$192,50
Kapasite	15,00-22,00 Kg
Halat Boyu	150cm



SB-70K	\$291,50
Kapasite	60,00-70,00 Kg
Halat Boyu	150cm

SB-3K	\$96,80
Kapasite	1,50-3,00 Kg
Halat Boyu	130cm

SB-30K	\$198,00
Kapasite	22,00-30,00 Kg
Halat Boyu	150cm

SB-80K	\$302,50
Kapasite	70,00-80,00 Kg
Halat Boyu	150cm

SB-5K	\$108,90
Kapasite	3,00-5,00 Kg
Halat Boyu	130cm

SB-40K	\$242,00
Kapasite	30,00-40,00 Kg
Halat Boyu	150cm

SB-90K	\$308,00
Kapasite	70,00-90,00 Kg
Halat Boyu	200cm

SB-9K	\$146,30
Kapasite	5,00-9,00 Kg
Halat Boyu	130cm

SB-50K	\$258,50
Kapasite	40,00-50,00 Kg
Halat Boyu	150cm

SB-100K	\$495,00
Kapasite	80,00-100,00 Kg
Halat Boyu	200cm

SB-15K	\$170,50
Kapasite	9,00-15,00 Kg
Halat Boyu	130cm

SB-60K	\$271,70
Kapasite	50,00-60,00 Kg
Halat Boyu	150cm

SB-120K	\$517,00
Kapasite	105,00-120,00 Kg
Halat Boyu	200cm

YAYLI BALANSERLER



SB-1200	\$8,80
Kapasite	0,60-1,50 Kg
Halat Boyu	90cm

SB-2000	\$8,80
Kapasite	1,00-2,00 Kg
Halat Boyu	90cm

SB-3000	\$11,00
Kapasite	1,00-3,00 Kg
Halat Boyu	90cm

SB-5000	\$14,30
Kapasite	3,00-5,00 Kg
Halat Boyu	90cm

HORTUMLU BALANSERLER



LR-09	\$64,90
Kapasite	1,50 Kg
Hortum Ölçüsü	5x8mm
Hortum Boyu	130cm



TAB-3N	\$74,80
Kapasite	1,50-3,00 Kg
Hortum Ölçüsü	6,5x10mm
Hortum Boyu	140cm

TAB-5N	\$85,80
Kapasite	3,00-5,00 Kg
Hortum Ölçüsü	6,5x10mm
Hortum Boyu	140cm

KUIK KAPLIN GÖVDE



GÖVDE	\$5,00
20-SH	1/4"-9mm
30-SH	3/8"-11mm
40-SH	1/2"-15mm

KUIK KAPLIN GÖVDE



GÖVDE	\$5,00
20-SM	1/4"
30-SM	3/8"
40-SM	1/2"

KUIK KAPLIN GÖVDE



GÖVDE	\$5,00
20-SF	1/4"
30-SF	3/8"
40-SF	1/2"

KUIK KAPLIN RAKOR

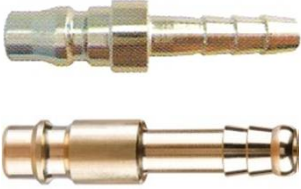

RAKOR	\$2,80
20-PH	1/4"-9mm
30-PH	3/8"-11mm
40-PH	1/2"-15mm

KUIK KAPLIN RAKOR



RAKOR	\$2,80
20-PM	1/4"
30-PM	3/8"
40-PM	1/2"

KUIK KAPLIN RAKOR

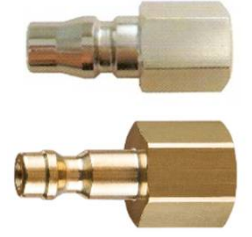

RAKOR	\$2,80
20-PF	1/4"
30-PF	3/8"
40-PF	1/2"

2'Lİ KUIK KAPLIN GÖVDE



2'Lİ GÖVDE	\$18,20
SMV	1/2"-15mm

TAKIM	\$23,70
1 ad.SMV Gövde +2 ad. Rakor	

3'LÜ KUIK KAPLIN GÖVDE



3'LÜ GÖVDE	\$29,20
SMY	1/2"-15mm

TAKIM	\$37,60
1 ad.SMY Gövde +3 ad. Rakor	

4'LÜ KUIK KAPLIN GÖVDE



4'LÜ GÖVDE	\$46,00
SMM	1/2"-15mm

TAKIM	\$57,20
1 ad.SMM Gövde +4 ad. Rakor	

SOMUN SIKMA-SÖKMELERİN DARBE MEKANİZMALARI



Darbe pimli çekiç sistemi



Gözlük çekiç sistemi



Tek çekiç sistemi



Çift çekiç sistemi