



TURNUS

ALTIKÖŞE ALLEN ANAHTAR TAKIMI



203-110	ALTIKÖŞE 10 parça / 0,05-3/8	€ 13,10
---------	---------------------------------	---------



205-104	ALTIKÖŞE 7 parça / 2,5-10mm	€ 25,60
---------	--------------------------------	---------

205-109	ALTIKÖŞE 7 parça / 3/32-3/8	€ 27,70
---------	--------------------------------	---------



204-990	ALTIKÖŞE 9 parça / 3/32-9/16	€ 61,00
---------	---------------------------------	---------



207-011	ALTIKÖŞE - UZUN 8 parça / 2-10mm	€ 44,10
---------	-------------------------------------	---------

207-012	ALTIKÖŞE - UZUN 8 parça / 5/64-3/8	€ 44,10
---------	---------------------------------------	---------

BOMBE BAŞLI ALTIKÖŞE ALLEN ANAHTAR TAKIMI



215-003	BOMBE BAŞ ALTIKÖŞE 9 parça / 1,5-10mm	€ 39,00
---------	--	---------

TORX ALLEN ANAHTAR TAKIMI



211-505	TORX 8 parça / T.09-T.40	€ 40,30
---------	-----------------------------	---------



212-258	TORX 8 parça / T.09-T.40	€ 42,10
---------	-----------------------------	---------



212-260	BOMBE BAŞ TORX 8 parça / T.09-T.40	€ 70,10
---------	---------------------------------------	---------

ALTIKÖŞE ALLEN ANAHTAR

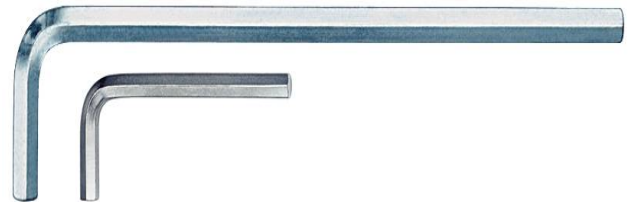

201-018	18mm - KISA 84x188mm	€ 20,20
---------	-------------------------	---------

201-020	20mm - KISA 90x200mm	€ 26,00
---------	-------------------------	---------

201-021	21mm - KISA 96x211mm	€ 34,30
---------	-------------------------	---------

204-014	14mm - UZUN 70x294mm	€ 19,20
---------	-------------------------	---------

204-022	22mm - UZUN 102x422mm	€ 67,80
---------	--------------------------	---------

204-024	24mm - UZUN 114x422mm	€ 98,10
---------	--------------------------	---------

204-027	27mm - UZUN 127x527mm	€ 153,90
---------	--------------------------	----------

TURNUS

CIRCIRLI KILAVUZ KOLU



280-085	KISA No:1 m3-10 85mm	€ 19,20
280-100	KISA No:2 m5-12 100mm	€ 22,40
280-250	UZUN No:1 m3-10 250mm	€ 28,80
280-300	UZUN No:2 m5-12 300mm	€ 38,40

İŞKENCE



420-028	28x25mm	€ 35,20
420-053	53x38mm	€ 41,60
420-078	78x50mm	€ 51,20
420-105	105x60mm	€ 67,90
420-130	130x70mm	€ 86,40
420-155	155x76mm	€ 96,00
420-206	206x86mm	€ 124,80

OTOMATİK İŞKENCE



472-012	120x60mm	€ 58,90
472-016	160x80mm	€ 64,20
472-020	200x100mm	€ 74,50
472-025	250x120mm	€ 85,30
472-030	300x140mm	€ 101,30
472-040	400x120mm	€ 106,40
472-050	500x120mm	€ 114,10
472-060	600x120mm	€ 118,70
472-080	800x120mm	€ 143,20
472-100	1000x120mm	€ 159,00

OTOMATİK İŞKENCE



485-010	100x80mm	€ 53,80
485-020	200x80mm	€ 59,40

İŞKENCE



473-020	200x120mm	€ 110,00
473-025	250x120mm	€ 112,20
473-030	300x120mm	€ 118,60
473-040	400x120mm	€ 126,00
473-050	500x120mm	€ 134,60
473-060	600x120mm	€ 139,60

ALLEN TORNAVİDA



171S-0,7mm	60-140mm	€ 10,00
171S-0,9mm	60-140mm	€ 10,00
171S-1,3mm	60-140mm	€ 10,00
171S-1,5mm	60-140mm	€ 10,00

TURNUS

AYARLI PENSE



690-125	125mm	€ 32,40
---------	-------	---------



691-250	250mm	€ 35,20
---------	-------	---------



692-250	250mm	€ 32,00
---------	-------	---------

CONTA KESME PERGELİ

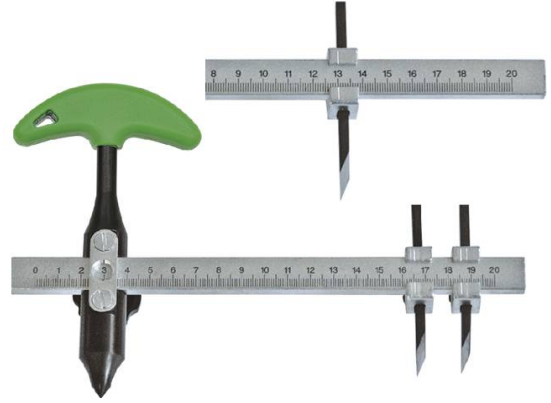

321-200	Tek Bıçak 200mm	€ 76,80
321-400	Tek Bıçak 400mm	€ 89,60
321-600	Tek Bıçak 600mm	€ 105,60

322-200	Çift Bıçak 200mm	€ 118,40
322-400	Çift Bıçak 400mm	€ 134,40
322-600	Çift Bıçak 600mm	€ 153,60

SAC MAKASI



978-300	300mm Sağ	€ 56,10
978-301	300mm Sol	€ 56,10

ÇAKMALI HARF



329-202	2mm	€ 41,60
329-203	3mm	€ 44,80
329-204	4mm	€ 48,00
329-205	5mm	€ 51,20
329-206	6mm	€ 57,60
329-208	8mm	€ 76,80
329-210	10mm	€ 102,40
329-212	12mm	€ 121,60

ÇAKMALI RAKAM



328-102	2mm	€ 12,80
328-103	3mm	€ 16,00
328-104	4mm	€ 16,00
328-105	5mm	€ 19,20
328-106	6mm	€ 19,20
328-108	8mm	€ 25,60
328-110	10mm	€ 35,20
328-112	12mm	€ 41,60



行业 领航者



台州鑫铭科技有限公司
TAIZHOU XINMING TECHNOLOGY CO.,LTD.

İKİ AYAKLI ÇEKTİRME

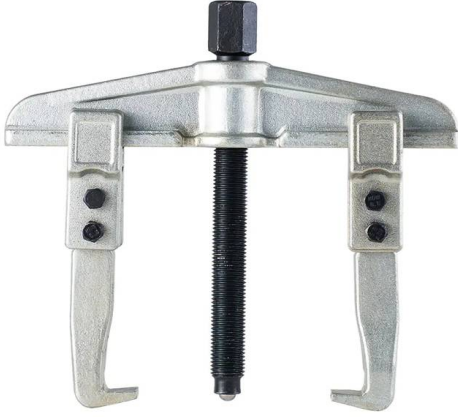

SN0218/06	(6") 150x160mm	\$99,00
SN0218/08	(8") 150x200mm	\$138,00

İKİ AYAKLI ÇEKTİRME



SN0220S/02	235x140mm	\$169,00
SN0220S/03	280x140mm	\$186,00

İKİ AYAKLI ÇEKTİRME



SN0211/04	(4") 65x65mm	\$19,00
SN0211/06	(6") 80x80mm	\$21,00

ÜÇ AYAKLI ÇEKTİRME



SN0117/04	(4") 65x65mm	\$24,00
SN0117/06	(6") 80x80mm	\$27,00

İKİ-ÜÇ AYAKLI ÇEKTİRME



SN0104-1/08	(8") 200mm	\$59,00
SN0104-1/10	(10") 250mm	\$97,00
SN-0104-1/12	(12") 300mm	\$122,00
SN0104-1/14	(14") 350mm	\$215,00

İKİ AYAKLI ÇEKTİRME



SN0212/04	(4") 40x85mm	\$24,00
SN0212/06	(6") 55x105mm	\$30,00
SN0212/08	(8") 70x130mm	\$33,00

ÜÇ AYAKLI RULMAN ÇEKTİRMESİ



SN0306	12-58mm	\$70,00
--------	---------	---------

İKİ-ÜÇ AYAKLI HİDROLİK ÇEKTİRME TAKIMI



SN1000	250x400mm	\$546,00
--------	-----------	----------

RULMAN ÇEKTİRME TAKIMI



SN0340-1/02	(2") 30x50mm	\$69,00
SN0340-1/03	(3") 50x75mm	\$99,00

HİDROLİK RULMAN ÇEKTİRME TAKIMI



SN0301-4	10Ton 75x105mm	\$350,00
----------	----------------	----------

RULMAN ÇEKTİRME TAKIMI



SN0301-2	30x75mm	\$162,00
SN0301-3	75x105mm	\$289,00

VURMALI İÇ-DIŞ RULMAN ÇEKTİRME TAKIMI



SN0362	15-30+30-80MM İç 15-80mm Dış	\$295,00
--------	---------------------------------	----------

AMORTİSÖR (YAY) ÇEKTİRME



SN0304	355mm	\$65,00
--------	-------	---------

ROTBAŞI ÇEKTİRMESİ



SN0333-1	22mm	\$30,00
----------	------	---------



SN0334	18mm	\$14,00
--------	------	---------



SN0335	18mm	\$20,00
--------	------	---------



SN0313	20mm	\$62,00
--------	------	---------

KOLLU MEKANİK BİJON ANAHTARLARI



SN0501	3800Nm - 1/58	\$111,00
--------	---------------	----------

SN0503	4800Nm - 1/68	\$111,00
--------	---------------	----------



IRWIN
VISE-GRIP



AMERICAN TOOLS - IRVIN

WR - STANDART TİP AYARLI PENSE



4"-100mm

4 WR

\$23,40

5"-125mm

5 WR

\$23,40

10"-250mm

10 WR

\$26,60

RR - DÜZ BIÇAK AĞIZLI TİP AYARLI PENSE



7"-175mm

7 RR

\$39,80

LN - UZUN AĞIZLI TİP AYARLI PENSE



6"-150mm

6 LN

\$33,90

AC - KAYNAKÇI TİP AYARLI PENSE



9"-225mm

9 AC

\$48,10

R - KİLİTLİ TİP ZİNCİRLİ BORU ANAHTARI



9"-225mm

20 R

\$48,10

AMERICAN TOOLS - IRVIN

R - C TİPİ STANDART AĞIZLI AYARLI PENSE



6"-150x50mm

6 R

\$26,60

11"-275x100mm

11 R

\$34,90

18"-455x200mm

18 R

\$51,40

GJP- FORT PENSE



10"-250mm

10 GJP

\$38,20

12"-300mm

12 GJP

\$44,80

GLGJP- KİLİTLİ TİP FORT PENSE



10"-250mm

10 GLGJP

\$59,70

12"-300mm

12 GLGJP

\$74,50

SAC MAKASI



9,1/2"-240mm

20 SL

\$43,10

AMERICAN TOOLS - IRVIN

KADEMELİ MATKAP



4-22mm
2mm Aralıklı

Unibit- 4

\$73,60

5-35mm
2-3mm Aralıklı

Unibit- 5

\$157,90

ALLEN ANAHTAR



5mm
ALTIKÖŞE

86858

\$0,90

6mm
ALTIKÖŞE

86859

\$1,10

PLASTİK STANTLI ALLEN ANAHTAR TAKIMI



ALTIKÖŞE
1,5-10mm /9'lu

98040

\$9,90

ÇAKI TİPİ ALLEN ANAHTAR TAKIMI



ALTIKÖŞE
1,5-6mm /6'li

98017

\$15,00

ALTIKÖŞE
2-8mm /7'li

98027

\$20,00

ALTIKÖŞE
5/64"-1/4" /9'lu

98091

\$21,70

TORX
T.6-T.25 /8'li

98055

\$33,20

TORX
T.30-T.55 /5'li

98058

\$54,80

POŞETLİ ALLEN ANAHTAR TAKIMI



ALTIKÖŞE
2-8mm /7'li

88060

\$8,80

TORX
T.10-T.50 /9'lu

88185

\$68,90

TORX
T.7-T.55 /13'lü

88186

\$86,40



DICK



DICK

KUYUMCU MAKASI



Tipi Düz-Yaysız
Boy 180mm

85-40851810

€ 22,90

ELEKTRONİKÇİ YANKESKİ



Tipi Yaylı
Boy 120mm

180E-41180070

€ 39,70

KUYUMCU MAKASI



Tipi Eğri
Boy 180mm

87-40871860

€ 28,40

ELEKTRONİKÇİ KARGABURUN



Tipi Yaylı
Boy 120mm

183E-41183070

€ 28,00

İĞNE PENSESİ



Tipi Düz
Boy 180mm

40151280

€ 33,20

KAPORTACI EĞESİ



Cinsi KOMPLE
Boy 350mm

14143510
14193500

€ 76,80

Cinsi SAP
Boy 350mm

14193500

€ 41,10

Cinsi Yedek eğe
Boy / Diş 350mm - 9"
Kalın diş

14143510

€ 37,10

Tipi Yedek eğe
Boy / Diş 350mm - 12"
İnce diş

14143520

€ 39,70

LAMA ALÜMİNYUM EĞE

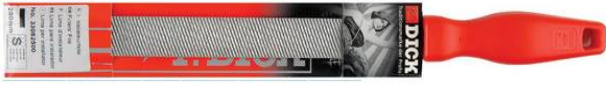

Boy 250mm

33082500

€ 27,40

YARIM YUVARLAK ALÜMİNYUM EĞE

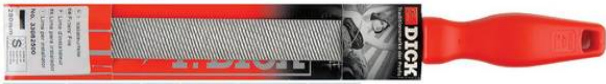

Boy 250mm

14042520

€ 32,90

GENEL AMAÇLI EĞE

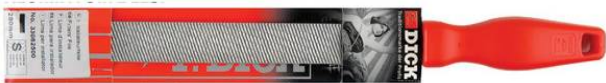

Boy 250mm

33052500

€ 13,10

TESVİYECİ EĞE TAKIMI



Boy 200mm

13142020

€ 45,20

DÜZ SAATÇİ TORNAVİDA TAKIMI



Düz ağızlı 6 parçalı takım

40918000-918

€ 25,40

ELMAS EĞE



23321600

Üçgen
160mm

€ 22,00

23322000

Üçgen
200mm

€ 24,80

23121600

Lama
160mm

€ 24,80

23122000

Lama
200mm

€ 27,90

23421600

Kare
160mm

€ 22,00

23422000

Kare
200mm

€ 24,80

23621600

Yuvarlak
160mm

€ 19,90

23622000

Yuvarlak
200mm

€ 24,80

23521600

Yarım Yuvarlak
160mm

€ 22,70

23522000

Yarım Yuvarlak
200mm

€ 26,80

ELMAS EĞE TAKIMI



Parça adedi

5 parça

Boy

160mm

Üçgen + Lama + Kare + Yuvarlak +

Yarım yuvarlak

23001600

€ 111,30

Parça adedi

5 parça

Boy

200mm

Üçgen + Lama + Kare + Yuvarlak +

Yarım yuvarlak

23002000

€ 123,60

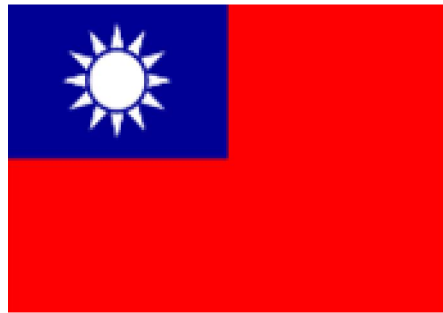

BITS UÇ VE ADAPTÖRLERİ

YILDIZ TORNAVİDA UÇLARI



1/4" -25mm
Ph0-1-2-3-4

\$0,50

1/4" -50mm
Ph1-2-3-4

\$0,90

1/4" -70mm
Ph1-2

\$1,50

1/4" -90mm
Ph1-2

\$1,70

1/4" -150mm
Ph2

\$4,20

ALLEN TORNAVİDA UÇLARI

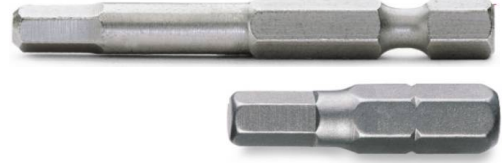

1/4" -30mm
m2-2,5-3-4
5-5,5-6-7

\$1,20

1/4" -50mm
m2-2,5-3-4-5-6

\$2,30

DELİKLİ TORX TORNAVİDA UÇLARI



1/4" -25mm
T.20

\$1,80

DÜZ TORNAVİDA UÇLARI



1/4" -25mm
No:3-4-5-6-8

\$0,90

1/4" -50mm
No:3-4-5-6-7

\$1,50

1/4" -90mm
No:6x8-8x10
10x12-12x14

\$2,30

BOMBE BAŞ ALLEN TORNAVİDA UÇLARI



1/4" -30mm
m2,5-3-4-5-6

\$1,80

KARE TORNAVİDA UÇLARI

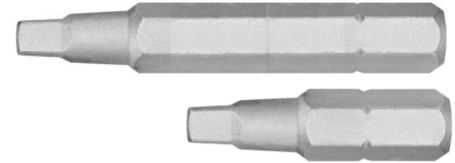

1/4" -25mm
S-0 (2mm)
S-1 (2,5mm)
S-2 (3mm)
S-3 (4,5mm)

\$1,20

1/4" -50mm
S-3 (4,5mm)

\$2,30

TORX TORNAVİDA UÇLARI



1/4" -25mm
T.7-8-9-10-15
20-25-27-30-40

\$1,20

1/4" -50mm
T.8-9-10-15-20
25-27-30-40

\$2,30

1/4" -70mm
T.30-40

\$5,80

BULUCULU DÜZ TORNAVİDA UÇLARI



1/4" -95mm
No:2-3-4

\$7,30

BITS UÇ VE ADAPTÖRLERİ

DARBELİ YILDIZ TORNAVİDA UÇLARI



5/16"-30mm
Ph2-3-4

\$2,60

DARBELİ DÜZ TORNAVİDA UÇLARI



5/16"-30mm
No:5-6-8-10-12

\$2,60

DARBELİ TORX TORNAVİDA UÇLARI



5/16"-30mm
T.40

\$4,60

MANYETİK UÇ ADAPTÖRLERİ



1/4"-60mm

\$9,20

1/4"-60mm

Inox

\$11,50

TORNAVİDA İÇİN LOKMA ANAHTAR



1/4"-40mm
m5,5-6-7
8-10-12-13

\$4,60

1/4"-65mm

Manyetik

m5,5-6-7
8-10-12-13

\$9,20

SOMUN SIKMA İÇİN UÇ ADAPTÖRLERİ



1/4"-1/4"
35mm

\$6,90

3/8"-1/4"
39mm

\$9,20

3/8"-5/16"
39mm

\$9,20

1/2"-1/4"
41mm

\$10,40

1/2"-5/16"
41mm

\$10,40

TORNAVİDA İÇİN LOKMA ADAPTÖRLERİ



1/4"-1/4"
30mm

\$4,60

1/4"-1/4"
65mm

\$5,20

1/4"-1/4"
100mm

\$6,90

1/4"-3/8"
65mm

\$6,00

1/4"-1/2"
65mm

\$8,10

LASER[®]
— TOOLS —

carolus 
by **GEDORE**



LASER

3/8" SOKETLİ AÇIK AĞIZ ANAHTAR TAKIMI



Soket	3/8"
Parça sayısı	10
Muhteviyatı	m10-11-13-14-15 16-17-18-19-22

3282

€ 85,00

CAROLUS

1/4" SOKETLİ LOKMA ANAHTAR TAKIMI



Soket	1/4"
Parça sayısı	13
Muhteviyatı	m4-5-6-7-8-10 11-12-13 Lokma Circir kol+Uç adp. Uzatma (2)

7400

€ 35,00

MATKAP UÇLU VIDA

MATKAP UÇLU (AKILLI) VIDA



Dın	7504N
1.000 adetlik Poşetlerde Poşet fiyatıdır. Kolisı 20.000 adettir.	

3,9x16 YSB

\$10,80



Record®



HAZET®



RECORD

TEL KESKİSİ



WC 6

7.1/2"-190mm
Yumuşak çelik: 6,5mm
Sert çelik: 5mm
Çelik parça: 4mm
Yay çeliği: 2,5mm
Elektrik kablosu: 6,5mm

€ 57,80

STİLSON TİPİ BORU ANAHTARI



300/10

10"- 250mm

€ 17,60

300/12

12"- 300mm

€ 20,90

300/14

14"- 350mm

€ 24,20

300/18

18"- 450mm

€ 35,20

300/24

24"- 600mm

€ 52,80

HAZET

SUPAP AYAR ANAHTARI



2769-1

€ 46,00

SUPAP YAY BASACAĞI



2577-1

€ 88,60

MAFSALLI LOKMA ANAHTAR TAKIMI



Soket
Ölçüler

1/2"
m10-13-14-17-19

900 G/5

€ 195,50



 **Eastman**®



EASTMAN

İZOLELİ PENSE



6" - 150mm

\$3,30

7" - 180mm

\$4,30

8" - 200mm

\$4,40

İZOLELİ YANKESKİ



6" - 150mm

\$3,70

7" - 180mm

\$3,90

İZOLELİ KARGABURUN



6" - 150mm

\$3,70

7" - 180mm

\$3,90

8" - 200mm

\$4,00

İZOLELİ KERPETEN



6" - 160mm

\$3,70

10" - 250mm

\$4,20

STİLSON TİPİ BORU ANAHTARI



14" - 350mm

\$7,00

18" - 450mm

\$12,60

24" - 600mm

\$23,10

DEMİR TESTERE KOLU



10 adet Yedeği ile

\$5,00

KOMBİNE ANAHTAR TAKIMI



6-32mm / 12'li

\$18,70

AĞIR TİP BORU ANAHTARI



14" - 350mm

\$14,30

EL GRES POMPASI



500cc

\$20,90

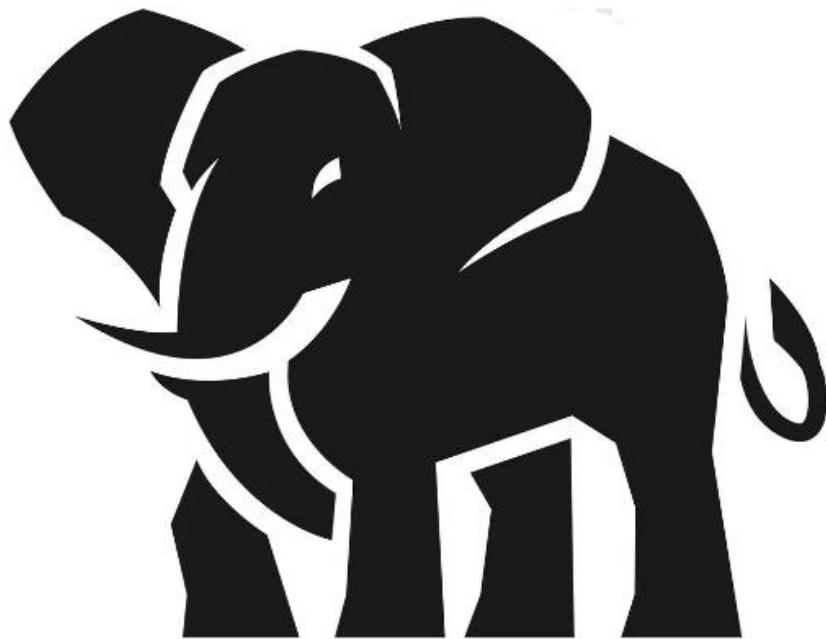

ELEPHANT

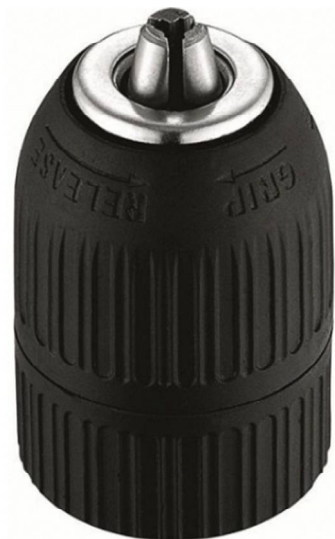

ELEPHANT

ANAHTARLI MANDREN



10mm	3/8"-24 dişli	\$1,85
10mm	1/2"-20 dişli	

13mm	3/8"-24 dişli	\$2,20
13mm	1/2"-20 dişli	
13mm	B.16 konik	

16mm	1/2"-20 dişli	\$7,55
16mm	B.16 konik	
16mm	B.18 konik	

20mm	B.22 konik	\$13,40
------	------------	---------

ELLE SIKMALI MANDREN



10mm	3/8"-24 dişli	\$12,30
10mm	1/2"-20 dişli	

13mm	1/2"-20 dişli	\$12,95
13mm	B.16 konik	

16mm	B.18 konik	\$13,95
------	------------	---------

MANDREN ANAHTARI



No.:1	\$0,70
-------	--------

No.:2	\$0,90
-------	--------

ELLE SIKMALI PLASTİK MANDREN



10mm	3/8"-24 dişli	\$1,65
------	---------------	--------

13mm	3/8"-24 dişli	\$2,30
13mm	1/2"-20 dişli	

DÖNER PUNTALAR



3 Mors	\$52,60
--------	---------

4 Mors	\$68,10
--------	---------

5 Mors	\$92,30
--------	---------



SIMPLEX®



SIMPLEX

MEKANİK CIRCIRLI VAGON KRİKOSU



Kapasite	5 Ton
Strok	330mm
İnik Haldeki Boyu	508mm
İnik Haldeki	46mm
Tırnak Boyu	46mm
Taban Ölçüleri	127x187mm
Ağırlığı	15,75kg

RJ 86 A

\$1.373,00

MEKANİK CIRCIRLI VAGON KRİKOSU



Kapasite	10 Ton
Strok	241mm
İnik Haldeki Boyu	438mm
İnik Haldeki	52mm
Tırnak Boyu	52mm
Taban Ölçüleri	152x222mm
Ağırlığı	18,00kg

RJ 1017

\$2.300,00

MEKANİK CIRCIRLI VAGON KRİKOSU



Kapasite	20 Ton
Strok	457mm
İnik Haldeki Boyu	717mm
İnik Haldeki	58mm
Tırnak Boyu	58mm
Taban Ölçüleri	203x280mm
Ağırlığı	46,80kg

RJ 2029

\$2.976,00

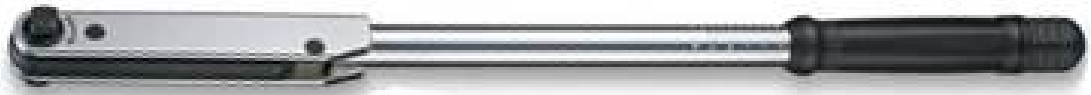

BRITTORQUE



BRITTORQUE

MEKANİK TORK ANAHTARLARI

TW-224 / 324 / 424 / 624 / 824 SERİSİ



Soket	1/4"
Kapasitesi	2,5-11nm 0,3-1,12kgm
Boyu	338mm

TW-224-1S

\$93,50

Soket	3/8"
Kapasitesi	2,5-11nm 0,3-1,12kgm
Boyu	338mm

TW-324-1S

\$93,50

Soket	3/8"
Kapasitesi	5-33nm 0,5-3,4kgm
Boyu	425mm

TW-324-2S

\$93,50

Soket	1/2"
Kapasitesi	12-68nm 1,2-7kgm
Boyu	500mm

TW-424-1S

\$110,00

Soket	1/2"
Kapasitesi	25-135nm 3-13kgm
Boyu	556mm

TW-424-2S

\$117,00



Soket	1/2"
Kapasitesi	50-225nm 5-23kgm
Boyu	600mm

TW-424-3S

\$134,80

Soket	1/2"
Kapasitesi	70-330nm 7-35kgm
Boyu	805mm

TW-424-4S

\$147,20

Soket	3/4"
Kapasitesi	140-560nm 14-57kgm
Boyu	996mm

TW-624-1S

\$409,80

Soket	3/4"
Kapasitesi	200-800nm 22-82kgm
Boyu	1070mm

TW-624-2S

\$445,50

Soket	1"
Kapasitesi	200-1000nm 22-100kgm
Boyu	1400mm

TW-824-2S

\$583,00

MEKANİK CIRCIRLI TORK ANAHTARLARI

TW-862 SERİSİ



Soket	1"
Kapasitesi	200-1000nm 20-100kgm
Boyu	1240mm

TW-862-2FV

\$583,00

Soket	1"
Kapasitesi	300-1500nm 30-150kgm
Boyu	1850mm

TW-862-3FV

\$1.500,00

MEKANİK CIRCIRLI TORK ANAHTARLARI

68867 SERİSİ



Soket	1"
Kapasitesi	200-800nm 22-82kgm
Boyu	1320mm

68867-2F

\$533,00

Soket	1"
Kapasitesi	300-1000nm 30-100kgm
Boyu	1320mm

68867-3F

\$600,00

MEKANİK GEÇME KAFALI TORK ANAHTARLARI

TW-634 SERİSİ



Bağlantı çapı	Ø 16mm
Kapasitesi	20-100nm 2-10kgm
Boyu	500mm

TW-634-2F

\$120,00

BRITTORQUE

MEKANİK CIRCIRLI TORK ANAHTARLARI

TW-822 SERİSİ



Soket	1"
Kapasitesi	400-2000nm 40-200kgm
Boyu	2300mm

TW-822-2FW

\$1.864,50

Soket	1"
Kapasitesi	500-2500nm 50-250kgm
Boyu	2755mm

TW-822-3FW

\$1.919,50

MEKANİK TORK ANAHTARLARI TORNAVİDA TİPİ TW-262 SERİSİ



Bits uç ağzı	1/4"
Kapasitesi	0,39-1,64nm 0,04-0,17kgm
Boyu	180mm

TW-262-12

\$121,00

Bits uç ağzı	1/4"
Kapasitesi	1-6nm 0,1-0,6kgm
Boyu	195mm

TW-262-02

\$121,00

Bits uç ağzı	1/4"
Kapasitesi	4-9nm 0,4-0,9kgm
Boyu	195mm

TW-262-03

\$121,00

TORK AÇI ÖLÇER



Soket	1/2"
-------	------

TW-414

\$49,50

TORK KARELERİ



3/8"

\$16,50

1/2"

\$16,50

3/4"

\$29,00

1"

\$44,00

TORK YÜKSELTİCİ



Soket Giriş-Çıkış	1/2"-1/2"
Tur Sayısı	3,4 : 1
Max.Çıkış Kap.	600nm/60kgm

TW-454-01

\$77,00



Soket Giriş-Çıkış	3/4"-1
Tur Sayısı	5 : 1
Max.Çıkış Kap.	2700nm/270kgm

TW-618

\$767,30



Soket Giriş-Çıkış	1/2"-1
Tur Sayısı	26 : 1
Max.Çıkış Kap.	4500nm/450kgm

TW-428-02

\$2.697,80



Cerim®



morrisflex



OVAL (STANDART DİŞLER)

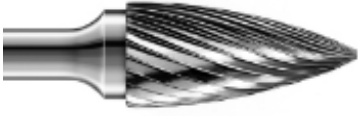

SİVRİ BAŞ

		Düz	Talaş Kırıcılı
3mm	3x16mm Sert metal	€ 8,00	
3mm	4x10mm Sert metal	€ 11,90	
6mm	6x20mm Sert metal	€ 16,30	€ 19,50
6mm	8x20mm Sert metal	€ 16,50	€ 19,80
6mm	10x20mm Sert metal	€ 20,50	€ 24,60
6mm	12x30mm Sert metal	€ 24,20	€ 29,00
6mm	12x30mm Hss	€ 11,30	

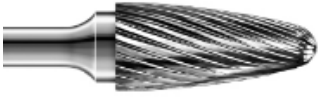

KÜT BAŞ

		Düz	Talaş Kırıcılı
3mm	3x16mm Sert metal	€ 9,30	
3mm	4x12mm Sert metal	€ 12,00	
3mm	6x16mm Sert metal	€ 16,40	
6mm	6x20mm Sert metal	€ 16,80	€ 20,10
6mm	8x20mm Sert metal	€ 18,10	€ 21,60
6mm	10x20mm Sert metal	€ 20,90	€ 25,00
6mm	12x25mm Sert metal	€ 25,20	€ 30,30
6mm	15x30mm Sert metal	€ 32,00	

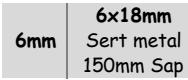

KÜRE BAŞ

		Düz	Talaş Kırıcılı
3mm	3x16mm Sert metal	€ 8,30	
3mm	4x8mm Sert metal	€ 11,50	
6mm	8x18mm Sert metal		€ 18,00
6mm	10x18mm Sert metal	€ 19,00	€ 21,00
6mm	12x25mm Sert metal	€ 24,00	€ 27,00
6mm	16x25mm Sert metal	€ 34,00	€ 37,40

SİLİNDİRİK (STANDART DİŞLER)

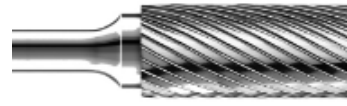

DÜZ BAŞ

		Düz	Talaş Kırıcılı
3mm	3x16mm Sert metal	€ 6,30	
6mm	6x20mm Sert metal	€ 12,90	€ 16,60
6mm	8x20mm Sert metal	€ 16,40	€ 19,80
6mm	10x20mm Sert metal	€ 18,60	€ 22,30
6mm	12x25mm Sert metal	€ 24,10	€ 28,90
6mm	16x25 Sert metal	€ 34,00	
6mm	30x30mm Ws	€ 10,00	

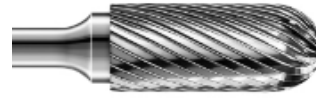

KÜRE BAŞ

		Düz	Talaş Kırıcılı
3mm	3x16mm Sert metal	€ 7,90	€ 9,00
6mm	6x20mm Sert metal	€ 14,50	€ 17,30
6mm	8x20mm Sert metal	€ 18,50	€ 22,20
6mm	10x20mm Sert metal	€ 21,40	€ 25,60
6mm	12x25mm Sert metal	€ 29,00	€ 34,70
6mm	16x25 Sert metal	€ 37,50	€ 46,30
6mm	6x20mm Hss	€ 6,90	
6mm	12x30mm Hss	€ 10,70	

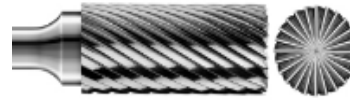

KESİCİ BAŞ

		Düz	Talaş Kırıcılı
3mm	3x16mm Sert metal	€ 7,50	€ 8,00
6mm	6x20mm Sert metal	€ 14,00	€ 15,00
6mm	8x20mm Sert metal	€ 17,50	€ 19,50
6mm	10x20mm Sert metal	€ 20,00	€ 22,00
6mm	12x25mm Sert metal	€ 26,00	€ 28,00
6mm	12x30mm Hss	€ 12,50	
6mm	12x30mm Ws	€ 6,30	

ÇAM (STANDART DİŞLER)

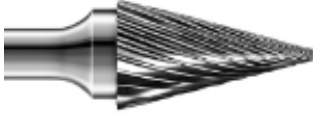

SİVRİ BAŞ

		Düz	Talaş Kırıcılı
3mm	3x14mm Sert metal	€ 8,30	
3mm	4x11mm Sert metal	€ 10,00	
3mm	6x14mm Sert metal	€ 11,00	€ 14,50
6mm	6x20mm Sert metal	€ 13,60	€ 16,30
6mm	8x18mm Sert metal	€ 12,80	€ 15,30
6mm	10x20mm Sert metal	€ 15,30	€ 18,30
6mm	12x25mm Sert metal	€ 20,80	€ 24,90
6mm	6x20mm Hss	€ 8,80	
6mm	10x18mm Hss	€ 9,40	
6mm	12x30mm Hss	€ 12,30	



KÜT BAŞ

		Düz	Talaş Kırıcılı
3mm	3x16mm Sert metal	€ 8,30	
3mm	4x16mm Sert metal	€ 11,30	
6mm	6x20mm Sert metal	€ 14,50	
6mm	8x25mm Sert metal	€ 20,50	€ 22,00
6mm	10x25mm Sert metal	€ 25,40	€ 27,50
6mm	12x32mm Sert metal	€ 30,40	€ 36,40
3mm	7x10mm Hss	€ 7,00	
6mm	10x15mm Hss	€ 10,00	
6mm	15x35mm Hss	€ 17,50	

KÜRE (STANDART DİŞLER)



		Düz
3mm	2mm Sert metal	€ 9,80
3mm	3mm Sert metal	€ 8,30
3mm	4mm Sert metal	€ 10,20
3mm	5mm Sert metal	€ 10,20
6mm	4mm Sert metal	€ 14,90
6mm	6mm Sert metal	€ 14,90
6mm	8mm Sert metal	€ 14,10
6mm	10mm Sert metal	€ 16,60
6mm	12mm Sert metal	€ 20,00
6mm	16mm Sert metal	€ 27,50
6mm	8mm Hss	€ 12,50
6mm	10mm Hss	€ 12,50
6mm	15mm Hss	€ 15,00

TRAPEZ (STANDART DİŞLER)

		Düz
6mm	2x3x3mm Hss	€ 7,00
6mm	8x12x30mm Hss	€ 11,00
6mm	20x30x30mm Ws	€ 12,00
		Düz
6mm	3x1mm Hss	€ 7,00

ÇAM (ALÜMİNYUM DİŞLER)



KÜRE BAŞ

		Alüminyum
6mm	8x25mm Sert metal	€ 22,00
6mm	12x32mm Sert metal	€ 36,40

SİLİNDİRİK (ALÜMİNYUM DİŞLER)



KÜT BAŞ

		Alüminyum
6mm	8x20mm Sert metal	€ 22,20
6mm	12x25mm Sert metal	€ 34,70
6mm	16x25 Sert metal	€ 46,30

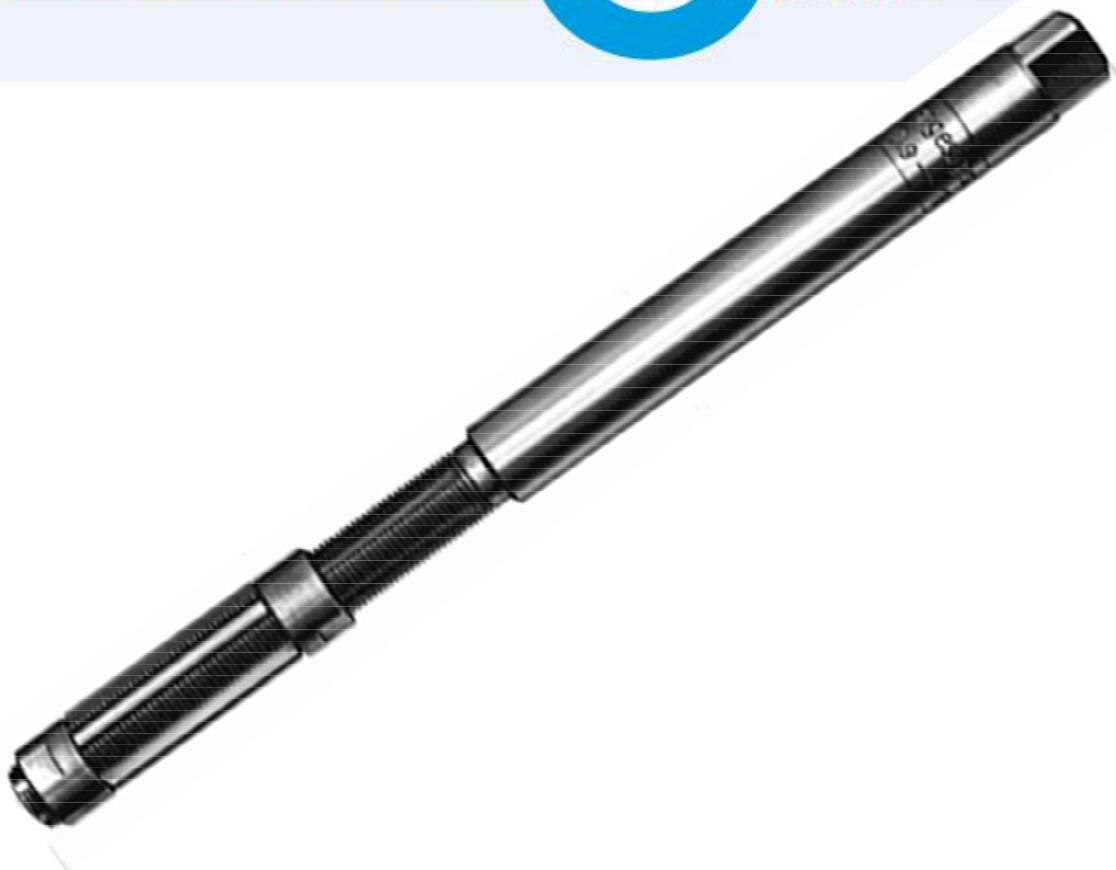

HUNGER

AYARLI RAYBALAR



Ölçü	D / KOVANSIZ		K / KOVANLI	
	Boy Bıçak Ad Bıçak Boy	Tek	Boy Bıçak Ad Bıçak Boy	Tek
7,2-8 9/32-5/16	111mm 4 / 32mm	€ 109,50		
8-9 5/16-23/64	111mm 5 / 32mm	€ 109,50	175mm 5 / 32mm	€ 161,70
9-10 23/64-25/64	115mm 5 / 32mm	€ 105,80	175mm 5 / 32mm	€ 161,70
10-11 25/64-7/16	120mm 5 / 35mm	€ 105,80	185mm 5 / 35mm	€ 166,60
11-12 7/16-15/32	125mm 5 / 35mm	€ 105,80	195mm 5 / 35mm	€ 167,80
12-13,5 15/32-17/32	130mm 5 / 42mm	€ 105,80	215mm 5 / 42mm	€ 173,90
13,5-15,5 17/32-39/64	145mm 5 / 50mm	€ 116,80	235mm 5 / 50mm	€ 176,30
15,5-18 39/64-45/64	165mm 5 / 60mm	€ 130,10	265mm 5 / 60mm	€ 184,80
18-21 45/64-53/64	180mm 5 / 65mm	€ 141,10	290mm 5 / 65mm	€ 204,30
21-24 53/64-15/16	190mm 5 / 70mm	€ 152,00	310mm 5 / 70mm	€ 227,40
24-27,5 15/16-1,5/64	205mm 5 / 75mm	€ 170,20	335mm 5 / 75mm	€ 260,20
27,5-31,5 1,5/64-1,15/64	225mm 6 / 80mm	€ 207,90	365mm 6 / 80mm	€ 304,00
31,5-37 1,15/64-1,29/64	240mm 6 / 90mm	€ 279,70	400mm 6 / 90mm	€ 423,10
37-45 1,29/64-1,49/64	285mm 6 / 100mm	€ 381,80	465mm 6 / 100mm	€ 586,00
45-55 1,49/64-2,5/32	320mm 6 / 109mm	€ 520,40	530mm 6 / 109mm	€ 776,90
55-65 2,5/32-2,9/16	350mm 8 / 120mm	€ 727,00	570mm 8 / 120mm	€ 1.056,50
65-80 2,9/16-3,5/32	460mm 10 / 145mm	€ 1.258,30	670mm 10 / 145mm	€ 1.702,00
80-95 3,5/32-3,47/64	490mm 10 / 150mm	€ 1.725,10	700mm 10 / 150mm	€ 2.364,60
95-110 3,47/64-4,21/64	490mm 10 / 150mm	€ 2.072,80	700mm 10 / 150mm	€ 2.996,70

Ölçü	Takım		Takım	
8-31,5 5/16-1,15/64	11 parça	€ 1.536,70	11 parça	€ 2.360,90
8-45 5/16-1,49/64	13 parça	€ 2.238,10	13 parça	€ 3.438,00

AYARLI SUPAP RAYBALARI



Ölçü	V / SUPAP	
	Boy Bıçak Ad Bıçak Boy	Tek
5,4-6 7/32-15/64	160mm 3 / 28mm	€ 125,30
5,9-6,5 15/64-1/4	160mm 3 / 28mm	€ 125,30
6,4-7 1/4-17/64	160mm 3 / 28mm	€ 125,30
6,9-7,5 17/64-19/64	160mm 3 / 28mm	€ 125,30
7,4-8 19/64-5/16	165mm 3 / 28mm	€ 125,30
7,9-8,5 5/16-21/64	170mm 3 / 28mm	€ 125,30
8,4-9 21/64-23/64	175mm 3 / 28mm	€ 125,30
8,9-9,5 23/64-3/8	180mm 4 / 32mm	€ 127,70
9,4-10 3/8-25/64	190mm 4 / 32mm	€ 127,70
9,9-11 25/64-7/16	200mm 5 / 36mm	€ 135,00
10,9-12 7/16-15/32	220mm 5 / 36mm	€ 137,40

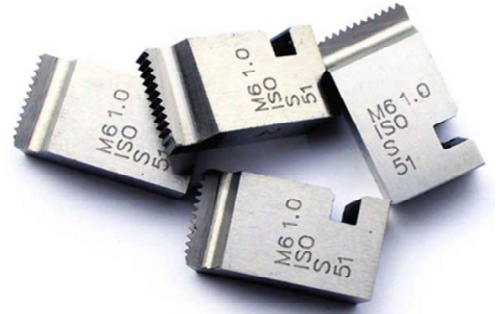

OSG
NAMCO
NEBSON
WMW

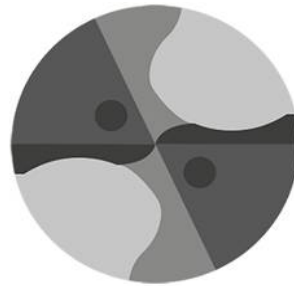

OSG

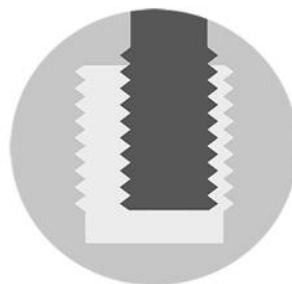

OTOMATİK PAFTA KAFA VE TARAKLARI

COVENTRY TİPİ OTOMATİK PAFTA KAFA VE TARAKLARI

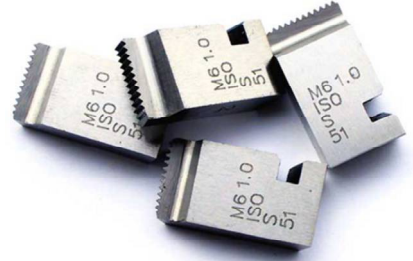

OSG JAPONYA	NEBSON İNGİLTERE WMW ALMANYA	KAFA ÖLÇÜSÜ	OSG-JAPONYA WMW-ALMANYA			NAMCO-İNGİLTERE NEBSON-İNGİLTERE		
			DİŞ					
			MM - BSW UNF - UNC	GAS	NPT - SOL			
€ 1.357,00		8 / H-1 2-8mm	€ 105,00	€ 120,00	€ 155,00			
€ 1.357,00	€ 1.000,00	13 / H-2 3-13mm	€ 105,00	€ 120,00	€ 155,00			
€ 1.652,00	€ 1.200,00	19 / H-3 6-19mm	€ 130,00	€ 160,00	€ 200,00			
€ 2.149,00	€ 2.000,00	25 / H-4 6-25mm	€ 155,00	€ 185,00	€ 230,00			
€ 3.114,00	€ 2.420,00	32 / H-5 10-32mm	€ 290,00	€ 350,00	€ 430,00			

OSG

3 AĞIZ KISA TİP HSS-Co PARMAK FREZE



ETS-3
DIN 327
HSS-E
%8 Co.

5mm
52x8mm
6mm
52x8mm

€ 14,00
€ 14,00

4 AĞIZ KISA TİP HSS-Co PARMAK FREZE

EMS-4
DIN 844
HSS-E
%8 Co.



2,5mm
52x8mm
3mm
52x8mm
3,5mm
54x10mm
4mm
55x11mm
5mm
57x13mm
6mm
57x13mm
8mm
69x19mm
20mm
104x38mm
22mm
104x38mm
26mm
121x45mm
28mm
121x45mm

€ 14,00
€ 14,00
€ 14,00
€ 14,00
€ 14,00
€ 14,00
€ 15,00
€ 38,50
€ 52,50
€ 77,00
€ 83,00

4 AĞIZ UZUN TİP HSS-Co PARMAK FREZE

EML-4
DIN 844
HSS-E
%8 Co.



5mm
68x24mm
6mm
68x24mm
10mm
95x45mm
12mm
110x53mm
14mm
110x53mm
16mm
123x63mm
24mm
166x90mm
26mm
166x90mm
28mm
166x90mm
30mm
166x90mm

€ 16,00
€ 17,00
€ 22,50
€ 26,50
€ 30,00
€ 36,50
€ 92,50
€ 108,00
€ 117,00
€ 140,50



A-AUST

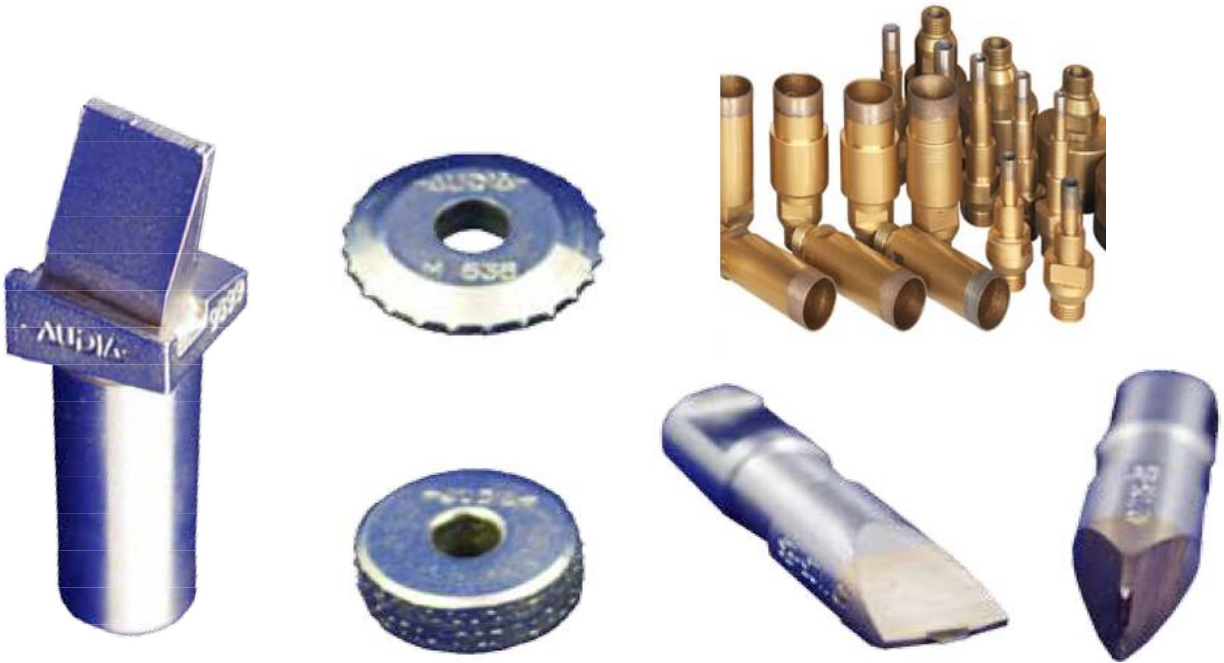

A-AUST

TEK TAŞ TAŞ DÜZELTME ELMASLARI



0,30 carat	14 x 64mm	€ 25,10
0,40 carat	14 x 64mm	€ 28,30
0,50 carat	14 x 64mm	€ 32,80
0,70 carat	14 x 64mm	€ 64,20
0,75 carat	14 x 64mm	€ 66,50
1,00 carat	14 x 64mm	€ 72,90
1,50 carat	14 x 64mm	€ 108,20
2,00 carat	14 x 64mm	€ 132,20
2,50 carat	14 x 64mm	€ 180,20
3,00 carat	14 x 64mm	€ 226,30
4,00 carat	14 x 64mm	€ 317,40
5,00 carat	14 x 64mm	€ 383,60
A Kalite	1,00 carat 103 / 9x31,5mm	€ 314,80
A Kalite	1,00 carat 104 / 16x42mm	€ 314,80
A Kalite	1,00 carat 110 / 9x25mm	€ 314,80

ELMAS TAŞ DÜZELTME PLAKALAR



K Tipi



S Tipi

PA-115S	33x23x5mm	€ 271,40
PA-115K	33x20,5x5mm	€ 208,80
PB-115K	33x10,5x5mm	€ 139,20
PC-115K	28x20,5x5mm	€ 174,30
PD-115S	28x13x5mm	€ 163,30
PD-115K	28x10,5x5mm	€ 125,40

SAPLI ELMAS TAŞ DÜZELTME PLAKALAR



PB-180K

€ 139,20

ÇOK TAŞLI TAŞ DÜZELTME ELMASLARI



1,00 carat	V60 taşlı 12,5x53mm	€ 135,70
1,00 carat	V60 taşlı 18x58mm	€ 135,70
2,50 carat	V60 taşlı 12,5x53mm	€ 145,50

ÇOK TAŞLI DAİRESEL TAŞ DÜZELTME ELMASLARI



402



405



0,75 carat	402 / 50 taşlı 15x5x6mm	€ 253,00
2,00 carat	405 / 160 taşlı 20x8x6mm	€ 487,10
SAP		€ 21,90

A-AUST

SAPLI TAŞ DÜZELTMELER



3,00 carat	€ 189,80
HA-G / 25x8mm	
3,00 carat	€ 189,80
HA-S / 25x8mm	

PROFİL ELMASLARI

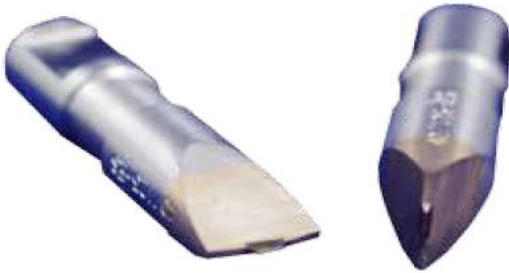

201	€ 300,20
40 / 0,125	
201	€ 300,20
40 / 0,250	
201	€ 300,20
40 / 0,500	
201	€ 300,20
60 / 0,250	
201	€ 300,20
60 / 0,500	
204	€ 300,20
Fortuna	

SERTLİK ÖLÇMELER

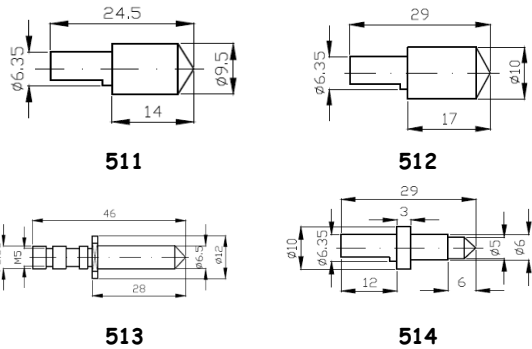

511	€ 291,00
Rockwell	
120 derece	
512	€ 291,00
Rockwell	
120 derece	
513	€ 310,00
Rockwell	
120 derece	
514	€ 310,00
Rockwell	
120 derece	

ELMAS PASTALAR



1 My	€ 111,60
10gr	
3 My	€ 138,00
10gr	
7 My	€ 164,50
10gr	
15 My	€ 164,50
10gr	
30 My	€ 190,90
10gr	
45 My	€ 264,50
10gr	
90 My	€ 264,50
10gr	

ELMAS CAM MATKAPLARI



5mm	€ 97,80
75mm	
8mm	€ 105,80
75mm	
10mm	€ 120,20
75mm	
12mm	€ 130,60
75mm	
16mm	€ 147,80
75mm	
20mm	€ 167,40
75mm	
24mm	€ 185,20
75mm	
26mm	€ 197,80
75mm	
34mm	€ 260,50
70mm	
42mm	€ 323,20
70mm	
49mm	€ 369,20
70mm	

7/8x14 UNF
Diş

ELMAS EĞELER



Lama	€ 18,40
160mm	
Kare	€ 18,40
160mm	
Üçgen	€ 18,40
160mm	
Yuvarlak	€ 18,40
160mm	
Yarım Yuvarlak	€ 18,40
160mm	



ALPHA



WOLFRAM-CARB

SERT METAL FREZE UCU

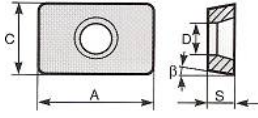

ADKA 1503..	
A=15 C=9,52 D=4,4 S=3,18	
Normal	€ 3,60
Kaplamalı	€ 4,60
Çok kapl.	€ 4,90

SERT METAL FREZE UCU

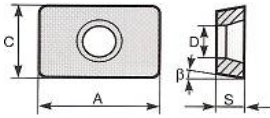

APKA 1504..	
A=15 C=9,52 D=4,4 S=3,18	
Normal	€ 4,60
Kaplamalı	€ 5,80
Çok kapl.	€ 6,20

APKA 2204..	
A=20 C=12,7 D=5,4 S=4,76	
Normal	€ 4,70
Kaplamalı	€ 6,00
Çok kapl.	€ 6,50

SERT METAL TORNA UCU

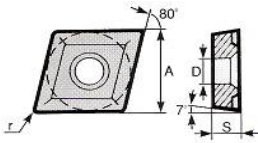

CCMT-09.T..	
A=9,52 D=4,4 S=3,97	
Normal	€ 3,10
Kaplamalı	€ 3,40
Çok kapl.	€ 3,70

SERT METAL TORNA UCU

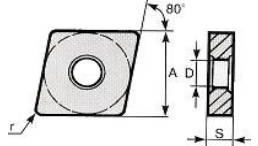

CNMA-1204..	
A=12,7 D=5,16 S=4,76	
Normal	€ 4,00
Kaplamalı	€ 4,90
Çok kapl.	€ 5,10

SERT METAL TORNA UCU

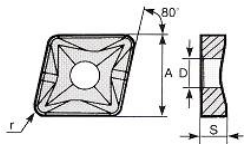

CNMM-1204..	
A=12,7 D=5,16 S=4,76	
Normal	€ 2,80
Kaplamalı	€ 3,10
Çok kapl.	€ 3,30

CNMM-1906..	
A=19,05 D=7,93 S=6,35	
Normal	€ 7,70
Kaplamalı	€ 8,60
Çok kapl.	€ 9,00

CNMM-1606..	
A=15,88 D=6,35 S=6,35	
Normal	€ 5,20
Kaplamalı	€ 5,80
Çok kapl.	€ 6,60

SERT METAL TORNA UCU

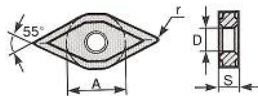

DNMG-1506..	
A=12,7 D=5,16 S=6,35	
Normal	€ 4,10
Kaplamalı	€ 5,40
Çok kapl.	€ 5,60

DNMG-1906..	
A=15,88 D=6,35 S=6,35	
Normal	€ 6,90
Kaplamalı	€ 8,50
Çok kapl.	€ 9,10

SERT METAL TORNA UCU

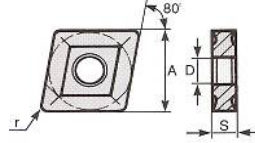

CNMG-1204..	
A=12,7 D=5,16 S=4,76	
Normal	€ 2,80
Kaplamalı	€ 3,10
Çok kapl.	€ 3,30

CNMG-1606..	
A=15,88 D=6,35 S=6,35	
Normal	€ 5,20
Kaplamalı	€ 5,80
Çok kapl.	€ 6,60

CNMG-2509	
A=25,4 D=9,12 S=9,52	
Normal	€ 18,90
Kaplamalı	€ 20,90
Çok kapl.	€ 23,10

CNMG-1906	
A=19,05 D=7,93 S=6,35	
Normal	€ 7,70
Kaplamalı	€ 8,60
Çok kapl.	€ 9,00

SERT METAL TORNA UCU

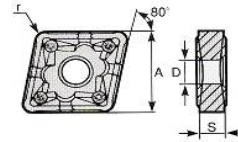

CNMX-1906..	
A=19,05 D=7,93 S=6,35	
Normal	€ 8,50
Kaplamalı	€ 9,40
Çok kapl.	€ 9,90

SERT METAL TORNA UCU

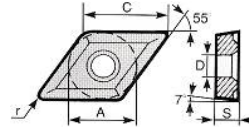

DCMT-11.T..	
A=9,52 C=11,6 D=4,4 S=3,97	
Normal	€ 2,70
Kaplamalı	€ 3,00
Çok kapl.	€ 3,20

SERT METAL TORNA UCU

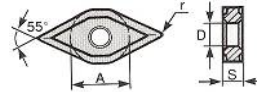

DNMA-1506..	
A=12,7 D=5,16 S=6,35	
Normal	€ 3,70
Kaplamalı	€ 4,10
Çok kapl.	€ 4,80

SERT METAL TORNA UCU

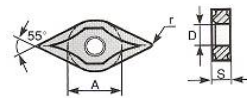

DNMM-1506..	
A=12,7 D=5,16 S=6,35	
Normal	€ 4,50
Kaplamalı	€ 5,00
Çok kapl.	€ 5,90

SERT METAL TORNA UCU

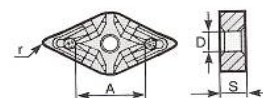

DNMX-1506..	
A=12,7 D=5,16 S=6,35	
Normal	€ 4,50
Kaplamalı	€ 5,00
Çok kapl.	€ 5,30

WOLFRAMCARB

WOLFRAM-CARB

SERT METAL TORNA UCU

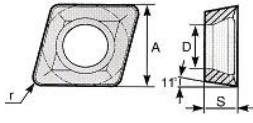

EPMM-0803..	
A=8 D=4,4 S=3	
Normal	€ 3,00
Kaplamalı	€ 3,90
Çok kapl.	€ 4,20

SERT METAL FREZE UCU

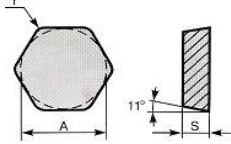

HPUN-0804	
A=14 S=4,76	
Normal	€ 5,40
Kaplamalı	€ 7,10
Çok kapl.	€ 7,60

SERT METAL TORNA UCU

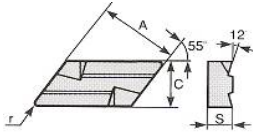

KNUX-1604..	
A=16,15 C=9,52 S=4,76	
Normal	€ 2,90
Kaplamalı	€ 3,70
Çok kapl.	€ 3,90

SERT METAL FREZE UCU

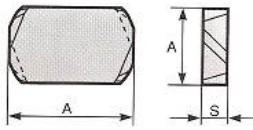

LNJN-2204..	
A=12,7 C=22 S=5	
Normal	€ 8,20
Kaplamalı	€ 9,80
Çok kapl.	€ 10,60

SERT METAL FREZE UCU

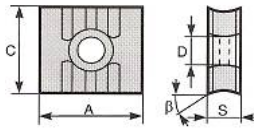

LNKN-1205..	
A=12,7 C=11,5 D=4,4 S=5,2	
Normal	€ 8,40
Kaplamalı	€ 10,70
Çok kapl.	€ 11,60

SERT METAL TORNA UCU

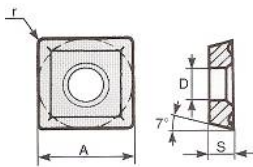

SCMM-0904..	
A=9,52 D=4,4 S=4	
Normal	€ 2,70
Kaplamalı	€ 2,90
Çok kapl.	€ 3,20

SCMM-1205..	
A=12,7 D=5,4 S=5	
Normal	€ 4,20
Kaplamalı	€ 4,60
Çok kapl.	€ 4,90

SERT METAL FREZE UCU

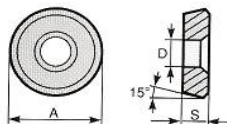

RDEA-10.T	
A=10 D=4,4 S=3,97	
Normal	€ 4,10
Kaplamalı	€ 5,70
Çok kapl.	€ 6,10

SERT METAL TORNA UCU

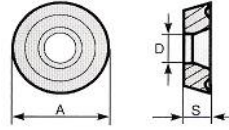

RCMX-1003	
A=10 D=3,6 S=3,18	
Normal	€ 2,50
Kaplamalı	€ 3,30
Çok kapl.	€ 3,60

RCMX-2507	
A=25 D=7,2 S=7,94	
Normal	€ 16,10
Kaplamalı	€ 19,60
Çok kapl.	€ 20,60

RCMX-1204	
A=12 D=4,2 S=4,76	
Normal	€ 3,80
Kaplamalı	€ 4,80
Çok kapl.	€ 5,00

RCMX-3209	
A=32 D=9,5 S=9,52	
Normal	€ 24,80
Kaplamalı	€ 28,80
Çok kapl.	€ 30,30

RCMX-2006	
A=20 D=6,5 S=6,35	
Normal	€ 7,40
Kaplamalı	€ 9,20
Çok kapl.	€ 9,70

SERT METAL TORNA UCU

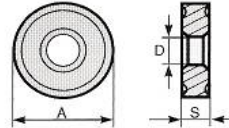

RNMG-0903	
A=9,52 D=3,81 S=3,18	
Normal	€ 2,20
Kaplamalı	€ 3,00
Çok kapl.	€ 3,20

RNMG-1906	
A=19,05 D=7,93 S=6,35	
Normal	€ 6,90
Kaplamalı	€ 8,50
Çok kapl.	€ 9,10

SERT METAL FREZE UCU

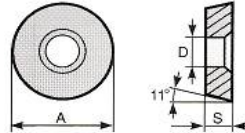

RPEA-1204	
A=12 D=4,4 S=4,76	
Normal	€ 4,30
Kaplamalı	€ 6,00
Çok kapl.	€ 6,50

SERT METAL TORNA UCU

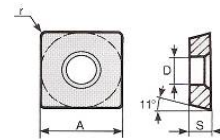

SCMA-1205..	
A=12,7 D=5,4 S=5	
Normal	€ 4,20
Kaplamalı	€ 4,60
Çok kapl.	€ 4,90

SERT METAL FREZE UCU

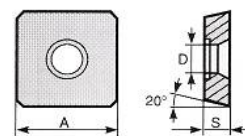

SEHX-1204..	
A=12,7 D=5,4 S=4,76	
Normal	€ 3,90
Kaplamalı	€ 5,10
Çok kapl.	€ 5,40

SEHX-1504..	
A=15,88 D=5,4 S=4,76	
Normal	€ 5,80
Kaplamalı	€ 7,30
Çok kapl.	€ 8,00

WOLFRAM-CARB

SERT METAL FREZE UCU

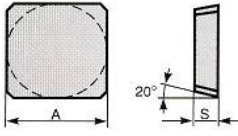

SDKN-1203..	
A=12,7 S=3,18	
Normal	€ 3,90
Kaplamalı	€ 5,10
Çok kapl.	€ 5,40

SERT METAL FREZE UCU

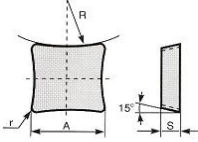

SDUX-1906..	
A=19 S=4,76	
Normal	€ 6,90
Kaplamalı	€ 8,50
Çok kapl.	€ 9,10

SERT METAL FREZE UCU

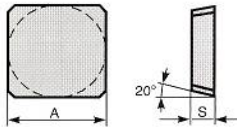

SECN-1203..	
A=12,7 S=3,18	
Normal	€ 4,60
Kaplamalı	€ 5,80
Çok kapl.	€ 6,20

SERT METAL FREZE UCU

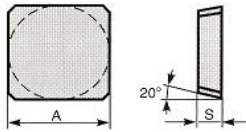

SEGN-0903..	
A=9,52 D=4,4 S=3,18	
Normal	€ 3,90
Kaplamalı	€ 5,10
Çok kapl.	€ 5,40

SERT METAL FREZE UCU

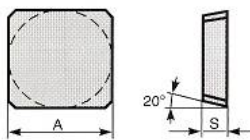

SEKN-1203..	
A=12,7 S=3,18	
Normal	€ 3,80
Kaplamalı	€ 4,90
Çok kapl.	€ 5,20

SEKN-1504..	
A=15,88 S=4,76	
Normal	€ 5,70
Kaplamalı	€ 7,20
Çok kapl.	€ 7,90

SERT METAL FREZE UCU

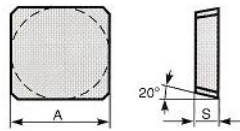

SEKR-1203..	
A=12,7 S=3,18	
Normal	€ 3,80
Kaplamalı	€ 4,90
Çok kapl.	€ 5,20

SERT METAL FREZE UCU

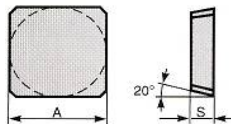

SFAN-1203	
A=12,7 S=3,18	
Normal	€ 6,90
Kaplamalı	€ 8,60
Çok kapl.	€ 9,10

SERT METAL FREZE UCU

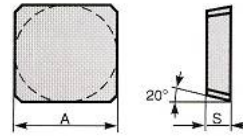

SEMN-1203..	
A=12,7 S=3,18	
Normal	€ 3,80
Kaplamalı	€ 4,90
Çok kapl.	€ 5,20

SEMN-1204..	
A=12,7 S=4,76	
Normal	€ 4,70
Kaplamalı	€ 6,10
Çok kapl.	€ 6,60

SERT METAL TORNA UCU

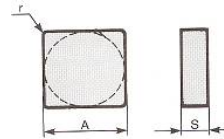

SNGN-1204..	
A=12,7 S=4,76	
Normal	€ 5,70
Kaplamalı	€ 6,40
Çok kapl.	€ 6,40

SERT METAL FREZE UCU

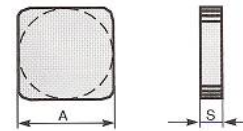

SNKN-1204..	
A=12,7 S=4,76	
Normal	€ 5,90
Kaplamalı	€ 7,60
Çok kapl.	€ 8,20

SNKN-1504..	
A=15,88 S=4,76	
Normal	€ 5,70
Kaplamalı	€ 7,20
Çok kapl.	€ 7,90

SERT METAL TORNA UCU

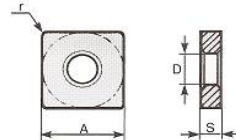

SNMA-1204..	
A=12,7 D=5,16 S=4,76	
Normal	€ 3,50
Kaplamalı	€ 4,30
Çok kapl.	€ 4,60

SNMA-2509..	
A=25,4 D=9,12 S=9,52	
Normal	€ 18,40
Kaplamalı	€ 22,50
Çok kapl.	€ 23,60

SNMA-1906..	
A=19,05 D=7,93 S=6,35	
Normal	€ 7,50
Kaplamalı	€ 9,00
Çok kapl.	€ 10,20

SERT METAL TORNA UCU

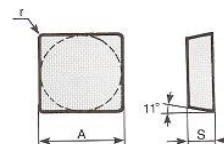

SPGN-1203..	
A=12,7 S=3,18	
Normal	€ 5,90
Kaplamalı	€ 7,00
Çok kapl.	€ 7,50

SPGN-1204..	
A=12,7 S=4,76	
Normal	€ 7,70
Kaplamalı	€ 9,30
Çok kapl.	€ 10,10

WOLFRAM-CARB

SERT METAL TORNA UCU

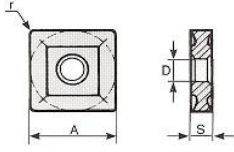

SNMG-0903..	
A=9,52 D=3,81 S=3,18	
Normal	€ 2,20
Kaplamalı	€ 3,00
Çok kapl.	€ 3,20

SNMG-1204..	
A=12,7 D=5,16 S=4,76	
Normal	€ 3,20
Kaplamalı	€ 3,50
Çok kapl.	€ 3,60

SNMG-2509..	
A=25,4 D=9,12 S=9,52	
Normal	€ 18,20
Kaplamalı	€ 25,60
Çok kapl.	€ 27,50

SNMG-2507..	
A=25,4 D=9,12 S=7,94	
Normal	€ 18,20
Kaplamalı	€ 21,70
Çok kapl.	€ 23,50

SERT METAL TORNA UCU

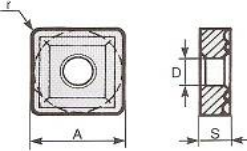

SNMM-1204..	
A=12,7 D=5,16 S=4,76	
Normal	€ 3,80
Kaplamalı	€ 4,90
Çok kapl.	€ 5,10

SNMM-1906	
A=19,05 D=7,93 S=6,35	
Normal	€ 8,70
Kaplamalı	€ 10,60
Çok kapl.	€ 11,00

SNMM-2509..	
A=25,4 D=9,12 S=9,52	
Normal	€ 22,50
Kaplamalı	€ 29,00
Çok kapl.	€ 31,30

SNMM-2507..	
A=25,4 D=9,12 S=7,94	
Normal	€ 19,10
Kaplamalı	€ 20,80
Çok kapl.	€ 21,90

SERT METAL TORNA UCU

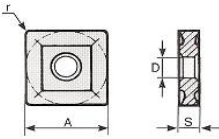

SNMX-1204..	
A=12,7 D=5,16 S=4,76	
Normal	€ 3,80
Kaplamalı	€ 4,90
Çok kapl.	€ 5,10

SERT METAL TORNA UCU

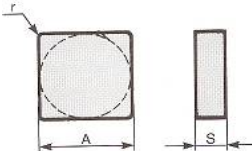

SNUN-1203..	
A=12,7 S=3,18	
Normal	€ 2,90
Kaplamalı	€ 3,80
Çok kapl.	€ 4,10

SNUN-1204..	
A=12,7 S=4,76	
Normal	€ 3,80
Kaplamalı	€ 4,80
Çok kapl.	€ 5,00

SNUN-1904..	
A=19,05 S=4,76	
Normal	€ 6,90
Kaplamalı	€ 8,60
Çok kapl.	€ 9,10

SNUN-1504..	
A=15,87 S=4,76	
Normal	€ 5,00
Kaplamalı	€ 6,40
Çok kapl.	€ 7,00

SERT METAL FREZE UCU

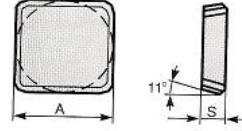

SPAN-1203..	
A=12,7 S=3,18	
Normal	€ 6,90
Kaplamalı	€ 8,60
Çok kapl.	€ 9,10

SERT METAL FREZE UCU

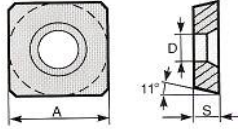

SPKA-1204..	
A=12,7 D=5,4 S=4,76	
Normal	€ 4,80
Kaplamalı	€ 6,20
Çok kapl.	€ 6,60

SERT METAL FREZE UCU

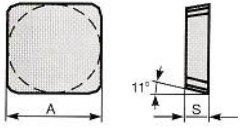

SPKN-1203..	
A=12,7 S=3,18	
Normal	€ 3,00
Kaplamalı	€ 3,80
Çok kapl.	€ 4,20

SPKN-1504..	
A=15,87 S=4,76	
Normal	€ 4,40
Kaplamalı	€ 5,60
Çok kapl.	€ 6,30

SERT METAL FREZE UCU

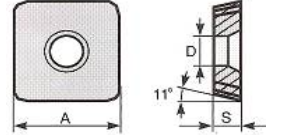

SPKX-1204..	
A=12,7 D=5,4 S=4,76	
Normal	€ 4,90
Kaplamalı	€ 6,30
Çok kapl.	€ 6,90

SERT METAL FREZE UCU

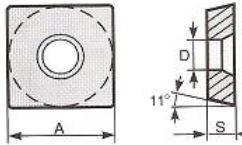

SPMA-0903..	
A=9,52 D=4,4 S=3,18	
Normal	€ 2,90
Kaplamalı	€ 3,70
Çok kapl.	€ 4,00

SPMA-1204..	
A=12,7 D=5,4 S=4,76	
Normal	€ 4,20
Kaplamalı	€ 5,40
Çok kapl.	€ 5,90

SERT METAL TORNA UCU

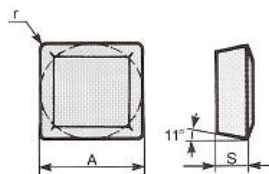

SPMR-0903..	
A=9,52 S=3,18	
Normal	€ 2,40
Kaplamalı	€ 2,60
Çok kapl.	€ 2,70

SPMR-1203..	
A=12,7 S=3,18	
Normal	€ 3,00
Kaplamalı	€ 3,30
Çok kapl.	€ 3,40

WOLFRAM-CARB

SERT METAL TORNA UCU

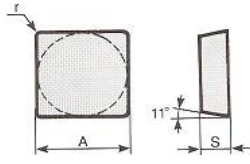

SPUN-0903..	
A=9,52 S=3,18	
Normal	€ 2,20
Kaplamalı	€ 2,40
Çok kapl.	€ 2,50

SPUN-1504..	
A=15,87 S=4,76	
Normal	€ 5,00
Kaplamalı	€ 6,50
Çok kapl.	€ 7,00

SPUN-1203..	
A=12,7 S=3,18	
Normal	€ 2,70
Kaplamalı	€ 3,00
Çok kapl.	€ 3,20

SPUN-1904..	
A=19,05 S=4,76	
Normal	€ 6,90
Kaplamalı	€ 8,60
Çok kapl.	€ 9,10

SPUN-1204..	
A=12,7 S=4,76	
Normal	€ 3,60
Kaplamalı	€ 4,60
Çok kapl.	€ 4,80

SERT METAL TORNA UCU

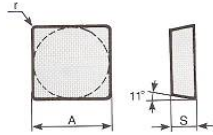

SPUX-1203..	
A=12,7 S=3,18	
Normal	€ 3,60
Kaplamalı	€ 4,60
Çok kapl.	€ 4,70

SERT METAL TORNA UCU

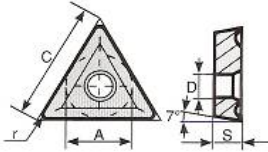

TCMA-2205	
A=12,7 C=22 D=5,4 S=4,76	
Normal	€ 5,90
Kaplamalı	€ 7,20
Çok kapl.	€ 7,60

SERT METAL TORNA UCU

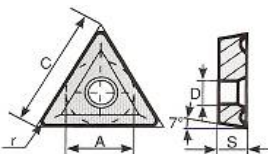

TCMM-1604..	
A=9,52 C=16,5 D=4,4 S=4	
Normal	€ 3,00
Kaplamalı	€ 3,30
Çok kapl.	€ 3,60

TCMM-2205..	
A=12,7 C=22 D=5,4 S=4,76	
Normal	€ 5,90
Kaplamalı	€ 7,20
Çok kapl.	€ 7,60

SERT METAL FREZE UCU

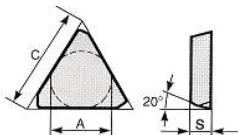

TEKN-2204..	
A=12,7 C=22 S=4,76	
Normal	€ 8,20
Kaplamalı	€ 9,90
Çok kapl.	€ 10,60

SERT METAL TORNA UCU

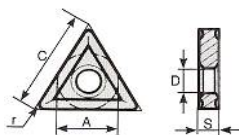

TNMB-1603	
A=9,52 C=16,5 D=3,81 S=3,18	
Normal	€ 2,20
Kaplamalı	€ 3,10
Çok kapl.	€ 3,20

SERT METAL TORNA UCU

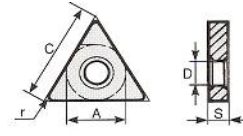

TNMA-1603	
A=9,52 C=16,5 D=3,81 S=3,18	
Normal	€ 2,20
Kaplamalı	€ 3,10
Çok kapl.	€ 3,20

TNMA-2204..	
A=12,7 C=22 D=5,16 S=4,76	
Normal	€ 3,80
Kaplamalı	€ 5,00
Çok kapl.	€ 5,30

TNMA-1604..	
A=9,52 C=16,5 D=3,81 S=4,76	
Normal	€ 2,90
Kaplamalı	€ 3,80
Çok kapl.	€ 4,00

SERT METAL TORNA UCU

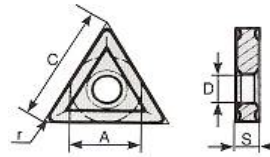

TNMG-1603..	
A=9,52 C=16,5 D=3,81 S=3,18	
Normal	€ 2,80
Kaplamalı	€ 3,20
Çok kapl.	€ 3,40

TNMG-1604..	
A=9,52 C=16,5 D=3,81 S=4,76	
Normal	€ 3,10
Kaplamalı	€ 4,00
Çok kapl.	€ 4,20

TNMG-2706	
A=15,87 C=27,5 D=6,35 S=6,35	
Normal	€ 7,40
Kaplamalı	€ 9,60
Çok kapl.	€ 10,10

TNMG-2204..	
A=12,7 C=22 D=5,16 S=4,76	
Normal	€ 3,80
Kaplamalı	€ 4,20
Çok kapl.	€ 4,40

SERT METAL TORNA UCU

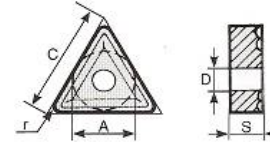

TNMM-1604..	
A=9,52 C=16,5 D=3,81 S=4,76	
Normal	€ 3,10
Kaplamalı	€ 4,00
Çok kapl.	€ 4,20

TNMM-2706..	
A=15,87 C=27,5 D=6,35 S=6,35	
Normal	€ 7,40
Kaplamalı	€ 9,60
Çok kapl.	€ 10,20

TNMM-2204..	
A=12,7 C=22 D=5,16 S=4,76	
Normal	€ 4,10
Kaplamalı	€ 5,20
Çok kapl.	€ 5,50

SERT METAL TORNA UCU

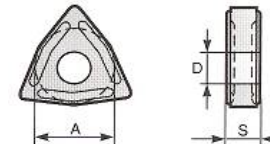

TNMX-1604..	
A=9,52 C=16,5 D=3,81 S=4,76	
Normal	€ 3,10
Kaplamalı	€ 4,00
Çok kapl.	€ 4,30

TNMX-2204..	
A=12,7 C=22 D=5,16 S=4,76	
Normal	€ 4,20
Kaplamalı	€ 5,40
Çok kapl.	€ 5,90



WOLFRAMCARB

WOLFRAM-CARB

SERT METAL TORNA UCU

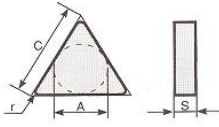

TNUN-1603..	
A=9,52 C=16,5 S=3,18	
Normal	€ 2,60
Kaplamalı	€ 3,50
Çok kapl.	€ 3,70

TNUN-2204..	
A=12,7 C=22 S=4,76	
Normal	€ 4,40
Kaplamalı	€ 5,50
Çok kapl.	€ 5,90

TNUN-1604..	
A=9,52 C=16,5 S=4,76	
Normal	€ 3,20
Kaplamalı	€ 4,10
Çok kapl.	€ 4,30

SERT METAL FREZE UCU

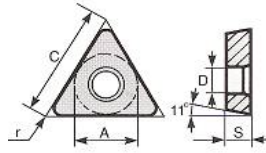

TPMA-1604..	
A=9,52 C=16,5 D=3,81 S=4,76	
Normal	€ 2,40
Kaplamalı	€ 3,00
Çok kapl.	€ 3,20

TPMA-2204..	
A=12,7 C=22 D=5,16 S=4,76	
Normal	€ 4,10
Kaplamalı	€ 5,30
Çok kapl.	€ 5,70

SERT METAL FREZE UCU

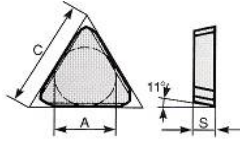

TPAN-1604..	
A=9,52 C=16,5 S=4,76	
Normal	€ 4,10
Kaplamalı	€ 5,20
Çok kapl.	€ 5,50

SERT METAL TORNA UCU

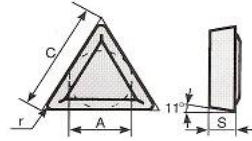

TPMR-1103..	
A=6,35 C=11 S=3,18	
Normal	€ 2,10
Kaplamalı	€ 2,30
Çok kapl.	€ 2,40

TPMR-2204..	
A=12,7 C=22 S=4,76	
Normal	€ 4,40
Kaplamalı	€ 5,50
Çok kapl.	€ 5,90

TPMR-1603..	
A=9,52 C=16,5 S=3,18	
Normal	€ 2,70
Kaplamalı	€ 3,00
Çok kapl.	€ 3,10

SERT METAL TORNA UCU

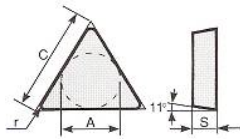

TPGN-1103..	
A=6,35 C=11 S=3,18	
Normal	€ 3,90
Kaplamalı	€ 4,40
Çok kapl.	€ 4,70

TPGN-1603..	
A=9,52 C=16,5 S=3,18	
Normal	€ 5,40
Kaplamalı	€ 5,90
Çok kapl.	€ 6,20

SERT METAL TORNA UCU

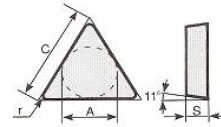

TPUN-1103..	
A=6,35 C=11 S=3,18	
Normal	€ 1,60
Kaplamalı	€ 2,10
Çok kapl.	€ 2,20

TPUN-2204..	
A=12,7 C=22 S=4,76	
Normal	€ 3,50
Kaplamalı	€ 4,30
Çok kapl.	€ 4,70

TPUN-1603..	
A=9,52 C=16,5 S=3,18	
Normal	€ 2,00
Kaplamalı	€ 2,70
Çok kapl.	€ 2,80

SERT METAL FREZE UCU

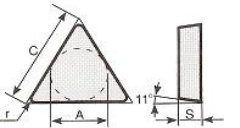

TPKA-1604..	
A=9,52 C=16,5 S=4,76	
Normal	€ 4,10
Kaplamalı	€ 5,20
Çok kapl.	€ 5,50

SERT METAL TORNA UCU

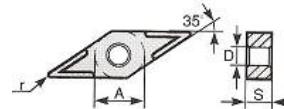

VNMG-2204..	
A=12,7 D=5,16 S=4,76	
Normal	€ 7,70
Kaplamalı	€ 10,70
Çok kapl.	€ 11,60

SERT METAL FREZE UCU

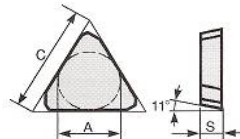

TPKN-1103..	
A=6,35 C=11 S=3,18	
Normal	€ 2,20
Kaplamalı	€ 2,90
Çok kapl.	€ 3,00

TPKN-2204..	
A=12,7 C=22 S=4,76	
Normal	€ 3,60
Kaplamalı	€ 4,60
Çok kapl.	€ 5,20

TPKN-1603..	
A=9,52 C=16,5 S=3,18	
Normal	€ 2,40
Kaplamalı	€ 3,10
Çok kapl.	€ 3,50

SERT METAL TORNA UCU

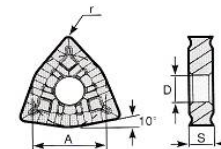

WNMG-0804..	
A=12,7 D=5,16 S=4,76	
Normal	€ 3,50
Kaplamalı	€ 3,90
Çok kapl.	€ 4,20

SERT METAL FREZE UCU

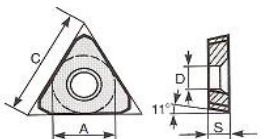

TPKX-1604..	
A=9,52 C=16,5 D=3,81 S=4,76	
Normal	€ 3,00
Kaplamalı	€ 3,90
Çok kapl.	€ 4,40

SERT METAL DIŞ UCU

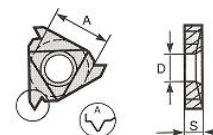

WIFD-1603..	
A=9,52 D=3,85 S=3,68	
Kaplamalı	€ 6,10

WOLFRAM-CARB

KATER ALTLIĞI

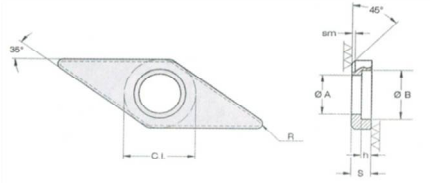

WSVN-2-0001

A=8,4 d1=5,6 d2=6,85 S=3,18

VNMG için

€ 1,60

WSVN-2-0002

A=8,4 d1=5,6 d2=6,85 S=3,18

VNMG için

€ 1,60

KATER ALTLIĞI

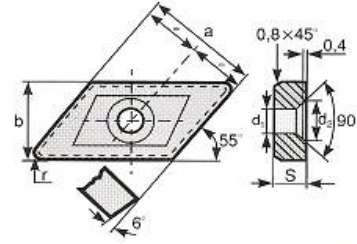

WKS-16R/L

b=9,4 a=14,5 d1=3,3

d2=6 S=4,76

KNUX için

€ 2,40

KATER ALTLIĞI

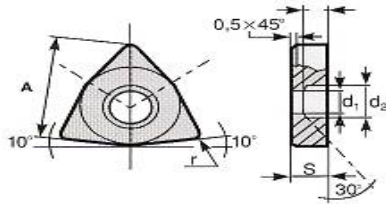

WSWN-2-0001

A=12,5 d1=6,6 d2=7,7 S=3,18

WNMG için

€ 1,70

WSWN-3-0001

A=12,5 d1=6,6 d2=7,7 S=3,18

WNMG için

€ 2,60

KATER ALTLIĞI

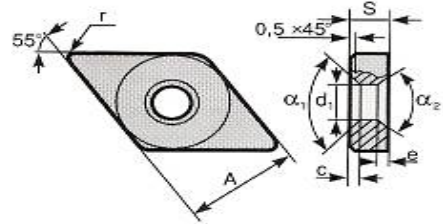

WSDN-2-0001

A=8,4 d1=5,6 S=3,18 r=0,8

DNMA, DNMG, DNMM
DNMX için

€ 1,30

WSDN-3-0001

A=11,8 d1=6,6 S=3,18 r=1,2

DNMA, DNMG, DNMM
DNMX için

€ 1,90

WSDN-4-0004

A=12,4 d1=7 S=4,76 r=1

DNMA, DNMG, DNMM
DNMX için

€ 2,70

KATER ALTLIĞI

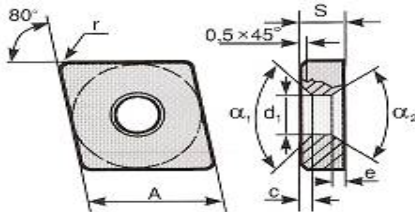

WSCN-3-0001

A=11,8 d1=6,6 S=3,18 r=1,2

CNMA, CNMG, CNMM
CNMX için

€ 1,80

WSCN-3-0002

A=14,6 d1=8,05 S=4,76 r=1,4

CNMA, CNMG, CNMM
CNMX için

€ 3,00

WSCN-3-0003

A=18,0 d1=9,75 S=7,76 r=1,6

CNMA, CNMG, CNMM
CNMX için

€ 4,10

KATER ALTLIĞI

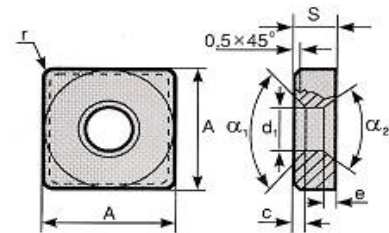

WSSN-3-0004

A=11,8 d1=6,6 S=3,18 r=1,2

SNMA, SNMG, SNMM
SNMX için

€ 1,70

WSSN-3-0023

A=16,6 d1=8,07 S=4,76 r=1,6

SNMA, SNMG, SNMM
SNMX için

€ 3,10

WSSN-3-0005

A=18,0 d1=9,75 S=4,76 r=1,2

SNMA, SNMG, SNMM
SNMX için

€ 4,10

WOLFRAM-CARB

KATER ALTLIĞI

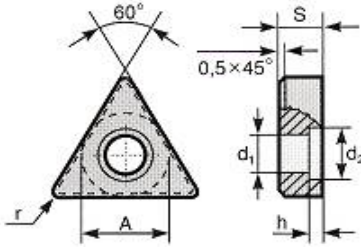

WSTN-3-0016

A=8,9 d1=5 S=3,18
r=0,8 c=1,3 e=0,7

TNMA, TNMG, TNMM
TNMX için

€ 1,60

WSTN-3-0015

A=11,8 d1=6,6 S=3,18
r=0,8 c=1,3 e=0,7

TNMA, TNMG, TNMM
TNMX için

€ 2,20

WSTN-2-0002

A=9,4 d1=5,2 d2=6,2 S=3,18
r=0,8 h=2,2

TNMA, TNMG, TNMM
TNMX için

€ 1,70

WSTN-2-1020

A=9,30 d1=5,6 d2=6,5
S=3,18 r=1,2 h=2,5

TNMA, TNMG, TNMM
TNMX için

€ 1,60

WSTN-2-1018

A=12,45 d1=6,26 d2=7,25
S=3,18 r=0,8 h=2,45

TNMA, TNMG, TNMM
TNMX için

€ 1,60

ATB SERİSİ SERT METAL KESME KALEMLERİ

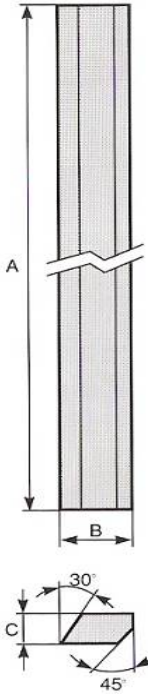

2 x6x165mm	€ 7,20
2 x8x165mm	€ 8,40
2 x10x165mm	€ 9,40
2 x12x165mm	€ 10,50
2 x14x165mm	€ 12,10
2 x16x165mm	€ 13,60
2 x18x165mm	€ 15,50
2 x20x165mm	€ 17,90
2 x22x165mm	€ 19,50
2 x24x165mm	€ 21,10

3 x6x165mm	€ 11,50
3 x8x165mm	€ 11,90
3 x10x165mm	€ 13,50
3 x12x165mm	€ 15,10
3 x14x165mm	€ 15,50
3 x16x165mm	€ 18,60
3 x18x165mm	€ 20,80
3 x20x165mm	€ 24,00
3 x22x165mm	€ 26,10
3 x24x165mm	€ 25,30
3 x26x165mm	€ 30,70
3 x28x165mm	€ 32,80
3 x30x165mm	€ 35,50

4 x8x165mm	€ 14,30
4 x10x165mm	€ 17,60
4 x12x165mm	€ 19,70
4 x14x165mm	€ 22,20
4 x16x165mm	€ 24,40
4 x18x165mm	€ 27,10
4 x20x165mm	€ 31,10
4 x22x165mm	€ 32,80
4 x24x165mm	€ 37,00
4 x26x165mm	€ 39,70
4 x28x165mm	€ 42,60
4 x30x165mm	€ 46,10
4 x32x165mm	€ 19,30
4 x34x165mm	€ 52,20
4 x36x165mm	€ 55,30
4 x40x165mm	€ 61,30

5 x22x165mm	€ 41,00
5 x23x165mm	€ 42,90
5 x24x165mm	€ 44,80
5 x25x165mm	€ 46,70
5 x26x165mm	€ 46,70
5 x30x165mm	€ 56,10

SERT METAL KESME KALEMLERİ

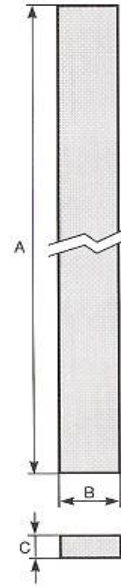

4 x1x100mm	€ 7,70
5 x3x100mm	€ 7,70
5 x4x100mm	€ 7,70
6 x4x100mm	€ 7,70
9 x3x100mm	€ 8,30
10 x2x140mm	€ 9,30
10 x2,5x100mm	€ 8,80
10 x2,5x140mm	€ 11,00
10 x3x100mm	€ 9,60
12 x2,5x100mm	€ 9,90
12 x3x100mm	€ 10,50
12 x3x140mm	€ 15,40
12 x3,5x100mm	€ 12,70
16 x2,5x100mm	€ 12,70
16 x2,5x140mm	€ 17,80
16 x3x100mm	€ 15,40
20 x2,5x100mm	€ 16,50
20 x3x100mm	€ 18,20
20 x3x140mm	€ 25,90
20 x3x160mm	€ 29,60

SERT METAL TORNA KALEMLERİ

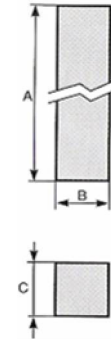

4 x4x100mm	€ 8,80
6 x6x100mm	€ 14,30
8 x8x100mm	€ 22,00
10 x10x100mm	€ 29,70
12 x12x100mm	€ 45,10
14 x14x100mm	€ 58,30
16 x16x100mm	€ 68,20
18 x18x100mm	€ 90,20

DÜĞMECİ ELMASLARI

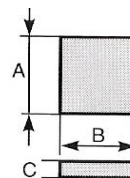

1,5 x10x10mm	€ 1,10
2 x8x5mm	€ 1,10
2 x14x4mm	€ 1,70
2 x30x10mm	€ 2,90

WOLFRAM-CARB

SERT METAL PANTOĞRAF KALEMLERİ

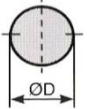
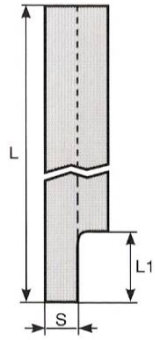
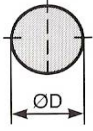
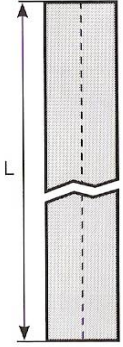

TAŞLANMIŞ

2 x100mm	€ 5,30
2,5 x100mm	€ 5,80
3 x100mm	€ 6,20
4 x80mm	€ 5,70
4 x100mm	€ 7,00
5 x100mm	€ 9,30
6 x100mm	€ 12,10
6 x150mm	€ 23,10
7 x100mm	€ 14,90
8 x60mm	€ 10,40
8 x100mm	€ 17,00
10 x100mm	€ 23,00
12 x100mm	€ 31,90
12 x150mm	€ 56,10
14 x100mm	€ 42,90
16 x100mm	€ 52,80
18 x100mm	€ 60,50
20 x100mm	€ 84,70

TAŞLANMIŞ-BİLENMİŞ

3 x100mm	€ 6,50
4 x100mm	€ 7,40
5 x100mm	€ 9,80
8 x60mm	€ 9,90
12 x150mm	€ 59,00
13 x100mm	€ 44,00

TAŞLANMAMIŞ

5 x100mm	€ 8,70
8 x100mm	€ 16,10
12 x100mm	€ 30,30
18 x100mm	€ 57,50

A/B SERİSİ KAYNAKLI SERT METAL UÇLAR

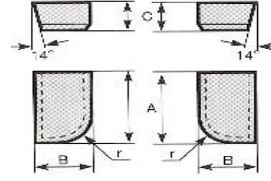

A/B-12	12x8x5mm	€ 1,70
A/B-16	16x10x6mm	€ 2,70
A/B-20	20x12x7mm	€ 3,90
A/B-25	25x14x8mm	€ 6,60
A/B-32	32x18x10mm	€ 16,50
A/B-40	40x22x12mm	€ 27,50
A/B-50	50x25x14mm	€ 49,50

C SERİSİ KAYNAKLI SERT METAL UÇLAR

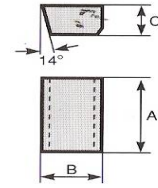

C-16	16x10x6mm	€ 2,80
C-20	20x12x7mm	€ 4,40
C-25	25x14x8mm	€ 7,70

E SERİSİ KAYNAKLI SERT METAL UÇLAR

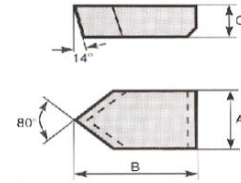

E-10	10x18x5mm	€ 2,20
E-16	16x22x7mm	€ 6,60
E-20	20x25x8mm	€ 9,90
E-25	25x28x9mm	€ 15,40

SERT METAL PARMAK FREZELER



2mm	€ 19,80
3mm	€ 19,80
4mm	€ 16,50
5mm	€ 18,70
6mm	€ 22,00
7mm	€ 33,00
8mm	€ 33,00
10mm	€ 46,20
12mm	€ 60,50
14mm	€ 85,80
16mm	€ 121,00
18mm	€ 137,50
20mm	€ 159,50

F SERİSİ KAYNAKLI SERT METAL UÇLAR

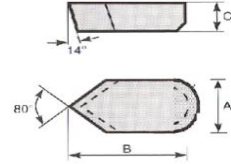

F-6	6x8x5mm	€ 1,40
F-8	8x10x6mm	€ 1,40
F-10	10x12x7mm	€ 2,80
F-12	12x14x8mm	€ 4,40
F-16	16x18x10mm	€ 9,90

BSM/F SERİSİ KAYNAKLI SERT METAL UÇLAR

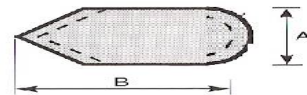

20x4x3	20x4x3mm	€ 1,10
30x5x4	30x5x4mm	€ 2,10
30x8x6	30x8x6mm	€ 3,90

SERT METAL PARMAK FREZE

TEK AĞIZ KISA TİP



5	5x20x50mm	€ 15,00
6	6x25x80mm	€ 28,30
8	8x25x80mm	€ 37,30

SERT METAL PARMAK FREZE

2 AĞIZ UZUN TİP



4	4x25x60mm	€ 25,60
5	5x25x75mm	€ 26,60
6	6x30x75mm	€ 28,30
8	8x30x75mm	€ 37,30
8	8x45x100mm	€ 48,10
10	10x40x100mm	€ 52,20
10	10x65x150mm	€ 89,30
12	12x40x100mm	€ 61,10
16	16x45x100mm	€ 127,80

SERT METAL PARMAK FREZE

2 AĞIZ KISA TİP



2	2x7x38mm	€ 13,50
2,5	2,5x7x38mm	€ 13,50
5	5x16x50mm	€ 15,00
6	6x16x50mm	€ 17,50
8	8x20x60mm	€ 22,80
10	10x22x76mm	€ 33,70
12	12x26x75mm	€ 45,60
14	14x32x83mm	€ 68,20
16	16x32x92mm	€ 77,50
20	20x38x100mm	€ 136,80
20	20x45x100mm	€ 136,80

SERT METAL PARMAK FREZE

3 AĞIZ KISA TİP



6	6x17x50mm	€ 17,50
10	10x25x63mm	€ 33,70
12	12x28x85mm	€ 45,60

SERT METAL PARMAK FREZE

4 AĞIZ UZUN TİP



4	4x25x60mm	€ 25,60
5	5x25x75mm	€ 26,60
6	6x30x75mm	€ 28,30
10	10x40x100mm	€ 52,20
10	10x65x150mm	€ 89,30
12	12x75x100mm	€ 125,60
14	14x75x150mm	€ 137,30
20	20x45x100mm	€ 172,50
20	20x75x150mm	€ 206,70

SERT METAL PARMAK FREZE

4 AĞIZ KISA TİP



2	2x8x38mm	€ 13,50
2	2x10x40mm	€ 13,50
2,5	2,5x10x40mm	€ 13,50
3	3x9x38mm	€ 12,00
3	3x12x40mm	€ 12,00
3,5	3,5x12x40mm	€ 14,30
4	4x12x40mm	€ 13,10
4	4x14x50mm	€ 13,10
5	5x14x50mm	€ 15,00
5	5x16x50mm	€ 15,00
6	6x17x50mm	€ 17,50
6	6x19x57mm	€ 17,50
6	6x22x63mm	€ 17,50
7	7x18x60mm	€ 25,80
10	10x20x72mm	€ 33,70
10	10x25x72mm	€ 33,70
12	12x27x83mm	€ 45,60
14	14x27x83mm	€ 68,20
14	14x35x82mm	€ 68,20
16	16x32x92mm	€ 77,50
18	18x32x92mm	€ 125,60
18	18x35x100mm	€ 125,60
20	20x36x100mm	€ 136,80
20	20x40x105mm	€ 136,80
25	25x45x120mm	€ 198,50

SERT METAL PARMAK FREZE

4 AĞIZ UZUN TİP-RADYUS BAŞLI



3	3x20x60mm	€ 26,60
4	4x25x60mm	€ 27,70
5	5x25x75mm	€ 29,90
6	6x28x75mm	€ 32,50
8	8x30x75mm	€ 42,60

SERT METAL PARMAK FREZE

4 AĞIZ KISA TİP-RADYUS BAŞLI



2	2x8x38mm	€ 15,00
2,5	2,5x9x38mm	€ 16,00
3	3x10x38mm	€ 14,10
4	4x13x50mm	€ 15,70
5	5x17x50mm	€ 19,40
6	6x20x57mm	€ 21,30
8	8x20x64mm	€ 28,10
10	10x21x72mm	€ 41,70

SERT METAL MATKAP UCU



4	4x20x55mm	€ 11,80
5	5x25x60mm	€ 14,90
6	6x25x65mm	€ 20,50
8	8x35x80mm	€ 37,60
9	9x40x85mm	€ 42,80

KILAVUZ VE PAFTA TAKIMLARI



MM

264800301

€ 385,00

M. 3-12

m3-4-5-6-7-8-9-10-11-12

Kilavuz kolu (2)-Pafta kolu (5)

264800401

€ 352,00

M. 5-12

m5-6-7-8-9-10-11-12

Kilavuz kolu (2)-Pafta kolu (4)

264800601

€ 759,00

M. 3-24

m3-4-5-6-8-10-12-14-16-18-20-22-24

Kilavuz kolu (2)-Pafta kolu (7)

264800701

€ 1.395,00

M. 5-30

m5-6-8-10-12-14-16-18-20-22-24-27-30

Kilavuz kolu (3)-Pafta kolu (7)



MM

49501

€ 125,00

M. 3-12

m3-4-5-6-8-10-12

Kilavuz kolu (1)-Pafta kolu (1)

Cırcırlı Kilavuz kolu (1)+Diş tarağı

10360009046

€ 228,50

M. 3-12

m3-4-5-6-8-10-12

Kilavuz kolu (2)-Pafta kolu (5)

Tornavida+Cırcırlı Kilavuz kolu (2)

Diş tarağı-Matkap ucu (7)

10360009146

€ 350,30

M. 3-20

m3-4-5-6-8-10-12-14-16-18-20

Kilavuz kolu (2)-Pafta kolu (6)

Tornavida+Cırcırlı Kilavuz kolu (2)

Tornavida+Diş tarağı

KILAVUZ VE PAFTA TAKIMLARI



Mf

264801002

€ 286,00

Mf. 3-12

mf3x0,35-4x0,5-5x0,5-6x0,75-8x0,75

8x1-10x1-12x1,5

Kilavuz kolu (2)-Pafta kolu (5)

264801102

€ 512,00

Mf. 6-20

mf6x0,75-8x0,75-8x1-10x1-12x1-12x1,5

14x1,25-14x1,5-16x1,5-18x1,5-20x1,5

Kilavuz kolu (2)-Pafta kolu (5)

264801202

€ 748,00

Mf. 6-24

mf6x0,75-8x0,75-8x1-10x1-12x1-12x1,5

14x1,25-14x1,5-16x1,5-18x1,5-20x1,5

22x1,5-24x1,5

Kilavuz kolu (2)-Pafta kolu (6)



UNC

264805003

€ 275,00

UNC 1/4"-1/2"

1/4-5/16-3/8-7/16-1/2

Kilavuz kolu (2)-Pafta kolu (4)

264805103

€ 480,00

UNC 1/4"-3/4"

1/4-5/16-3/8-7/16-1/2-5/8-3/4

Kilavuz kolu (2)-Pafta kolu (5)

264805303

€ 730,00

UNC 1/4"-1"

1/4-5/16-3/8-7/16-1/2-5/8-3/4-7/8-1

Kilavuz kolu (2)-Pafta kolu (6)

264805403

€ 1.830,00

UNC 1/4"-1.1/2"

1/4-5/16-3/8-7/16-1/2-5/8-3/4-7/8-1

1.1/8-1.1/4-1.3/8-1.1/2

Kilavuz kolu (3)-Pafta kolu (7)

KILAVUZ VE PAFTA TAKIMLARI

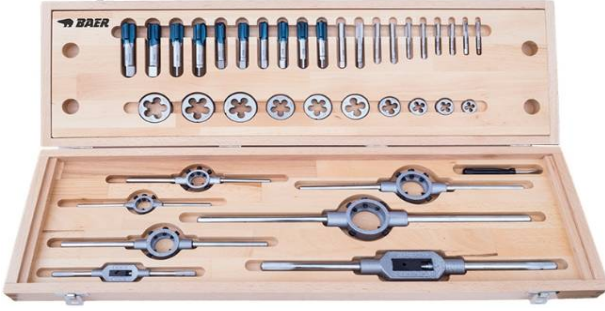

BSW

264803010

€ 319,00

BSW 1/8"-1/2"

1/8-3/16-1/4-5/16-3/8-7/16-1/2
Kilavuz kolu (2)-Pafta kolu (5)

264803110

€ 275,00

BSW 1/4"-1/2"

1/4-5/16-3/8-7/16-1/2
Kilavuz kolu (2)-Pafta kolu (4)

264803210

€ 480,00

BSW 1/4"-3/4"

1/4-5/16-3/8-7/16-1/2-5/8-3/4
Kilavuz kolu (2)-Pafta kolu (5)

264803410

€ 730,00

BSW 1/4"-1"

1/4-5/16-3/8-7/16-1/2-5/8-3/4-7/8-1
Kilavuz kolu (2)-Pafta kolu (6)

264803510

€ 1.830,00

BSW 1/4"-1.1/2"

1/4-5/16-3/8-7/16-1/2-5/8-3/4-7/8-1
1.1/8-1.1/4-1.3/8-1.1/2
Kilavuz kolu (3)-Pafta kolu (7)



UNF

264806004

€ 255,00

UNF 1/4"-1/2"

1/4-5/16-3/8-7/16-1/2
Kilavuz kolu (2)-Pafta kolu (4)

264806104

€ 425,00

UNF 1/4"-3/4"

1/4-5/16-3/8-7/16-1/2-5/8-3/4
Kilavuz kolu (2)-Pafta kolu (5)

264806304

€ 640,00

UNF 1/4"-1"

1/4-5/16-3/8-7/16-1/2-5/8-3/4-7/8-1
Kilavuz kolu (2)-Pafta kolu (6)

KILAVUZ VE PAFTA TAKIMLARI



G-BSP

264802014

€ 627,00

G-BSP 1/8"-1"

1/8-1/4-3/8-1/2-3/4-1
Kilavuz kolu (3)-Pafta kolu (5)

264802114

€ 836,00

G-BSP 1/8"-1"

1/8-1/4-3/8-1/2-5/8-3/4-7/8-1
Kilavuz kolu (3)-Pafta kolu (5)

264802214

€ 1.785,00

G-BSP 1/4"-1.1/2"

1/4-3/8-1/2-3/4-1.1/4-1.1/2
Kilavuz kolu (3)-Pafta kolu (6)

DÖKÜM KILAVUZ KOLLARI



No:0

130mm

€ 4,60

m1-8

1/16-1/4

No:1

176mm

€ 4,80

m1-10

1/16-3/8 G1/8

No:1.1/2

176mm

€ 4,80

m1-12

1/16-1/2 G1/8

No:2

280mm

€ 7,90

m4-12

5/32-1/2 G1/8

No:3

380mm

€ 15,60

m5-20

7/32-3/4 G1/8-1/2

No:4

505mm

€ 29,40

m11-27

7/16-1 G1/4-3/4

No:5L

700mm

€ 40,80

m13-32

1/2-1,1/4 G1/4-1

ÇELİK KILAVUZ KOLLARI



No:0	130mm	€ 7,50
m1-8	1/16-1/4	
No:1	180mm	€ 8,60
m1-10	1/16-3/8 G1/8	
No:1.1/2	205mm	€ 8,60
m1-12	1/16-1/2 G1/8	
No:2	280mm	€ 15,40
m4-12	5/32-1/2 G1/8	
No:3	380mm	€ 29,50
m5-20	7/32-3/4 G1/8-1/2	
No:4	500mm	€ 52,00
m11-27	7/16-1 G1/4-3/4	
No:5	700mm	€ 61,00
m13-32	1/2-1,1/4 G1/4-1	
No:6	1000mm	€ 102,00
m18-42	3/4-1,1/2 G1/2-1,1/4	
No:7	1250mm	€ 114,00
m25-52	1-2,1/8 G3/4-2,1/4	
No:8	1250mm	€ 276,00
m25-64	1-2,1/2 G3/4-3	

CIRCIRLI KILAVUZ KOLLARI



No:1	85mm	€ 10,20
m3-10	1/8-3/8	
No:10	250mm	€ 16,80
m3-10	1/8-3/8	

DÖKÜM PAFTA KOLLARI



16x5	160mm	€ 3,60
m1-2,6	BSW 1/16-3/32	
20x5	200mm	€ 3,60
m3-4	BSW 1/8-5/32	
20x7	200mm	€ 3,60
m4,5-6	BSW 3/16-1/4	
25x9	224mm	€ 4,40
m7-9	BSW 5/16	
30x11	280mm	€ 7,10
m10-11	BSW 3/8-7/16	
38x10	315mm	€ 11,60
m-ince 12-15	G 1/4	
38x14	315mm	€ 11,60
m12-14	BSW 1/2-9/16	
45x14	450mm	€ 14,30
m-ince 16-20	G 3/8-1/2	
45x18	450mm	€ 14,30
m16-20	BSW 5/8-13/16	
55x16	560mm	€ 18,80
m-ince 22-26	G 5/8-3/4	
55x22	560mm	€ 18,80
m22-24	BSW 7/8-1	
65x18	630mm	€ 26,40
m-ince 27-36	G 7/8-1	
65x25	630mm	€ 26,40
m27-36	BSW 1,1/8-1,3/8	
75x22	800mm	€ 49,00
m38-42	BSW 1,1/2-1,11/16	

No:2	100mm	€ 12,60
m5-12	7/32-1/2	
No:20	300mm	€ 20,40
m5-12	7/32-1/2	

PAFTALAR



METRİK DİŞ	
MM	DİN:223
1x0,25	€ 12,30
1,2x0,25	€ 12,30
1,4x0,3	€ 12,30
1,7x0,35	€ 12,30
2x0,4	€ 10,70
2,3x0,4	€ 10,70
2,5x0,45	€ 10,70
2,6x0,45	€ 10,70
3x0,5	€ 5,10
3,5x0,6	€ 7,90
4x0,7	€ 5,10
4,5x0,75	€ 7,90
5x0,8	€ 5,40
6x1	€ 5,40
7x1	€ 8,60
8x1,25	€ 5,70
10x1,5	€ 8,60
12x1,75	€ 13,90
14x2	€ 13,90
16x2	€ 21,50
18x2,5	€ 21,50
20x2,5	€ 21,50
22x2,5	€ 42,00
24x3	€ 42,00
27x3	€ 56,20
30x3,5	€ 56,20
33x3,5	€ 60,00
36x4	€ 60,00
42x4,5	€ 98,00
SOL	
4x0,7	€ 8,90
5x0,8	€ 9,50
6x1	€ 9,50
8x1,25	€ 11,00
10x1,5	€ 14,40
12x1,75	€ 20,50
14x2	€ 23,50
16x2	€ 32,60
18x2,5	€ 32,60
20x2,5	€ 32,60
22x2,5	€ 49,20
24x3	€ 49,20

KALIN DİŞ	
BSW	DİN:223
1/8x40	€ 11,20
5/32x32	€ 11,20
3/16x24	€ 11,20
1/4x20	€ 11,20
5/16x18	€ 12,80
3/8x16	€ 14,20
7/16x14	€ 16,50
1/2x12	€ 18,50
9/16x12	€ 22,90
5/8x11	€ 25,00
3/4x10	€ 25,00
7/8x9	€ 42,80
1x8	€ 42,80
1,1/8x7	€ 64,70
1,1/4x7	€ 64,70
1,3/8x6	€ 64,70
1,1/2x6	€ 64,70

METRİK İNCE DİŞ	
Mf	DİN:223
3x0,35	€ 11,80
4x0,5	€ 11,80
5x0,5	€ 11,80
6x0,75	€ 10,20
8x0,75	€ 10,70
8x1	€ 10,70
9x1	€ 16,10
10x1	€ 12,30
10x1,25	€ 12,30
12x1	€ 15,70
12x1,25	€ 15,70
12x1,5	€ 15,20
13x1,5	€ 20,70
14x1	€ 20,70
14x1,25	€ 17,30
14x1,5	€ 17,30
16x1	€ 28,10
16x1,25	€ 28,10
16x1,5	€ 22,10
18x1	€ 25,80
18x1,5	€ 22,10
18x2	€ 26,40
20x1,5	€ 22,10
20x2	€ 26,40
22x1,25	€ 42,70
22x1,5	€ 38,50
22x2	€ 42,70
24x1,5	€ 38,50
24x2	€ 42,70
26x1,5	€ 55,10
27x1,5	€ 63,00
28x1	€ 63,00
28x1,5	€ 63,00
30x1,5	€ 63,00
30x2	€ 63,00
30x3	€ 63,00
32x1,5	€ 63,00
32x2	€ 63,00
33x1,5	€ 63,00
36x1,5	€ 63,00
36x18	€ 63,00
38x1,5	€ 102,00
39x1,5	€ 102,00
42x18	€ 102,00
48x2	€ 170,00

KONİK BORU DİŞ	
NPT	
1/8x27	€ 40,20
1/4x18	€ 49,20
3/8x18	€ 62,40
1/2x14	€ 62,40
3/4x14	€ 99,60
1x11,5	€ 147,60

İNCE DİŞ	
UNF	DİN:223
8-36	€ 11,80
10-32	€ 11,80
12-32	€ 11,80
14-24	€ 11,80
1/4x28	€ 11,20
5/16x24	€ 12,80
3/8x24	€ 14,20
7/16x20	€ 16,50
1/2x20	€ 18,50
9/16x18	€ 22,90
5/8x18	€ 25,00
3/4x16	€ 25,00
7/8x14	€ 42,80
1x12	€ 42,80
1x14	€ 42,80
1,1/8x12	€ 64,70
1,1/4x12	€ 64,70
1,3/8x12	€ 64,70
1,1/2x12	€ 64,70

İNCE DİŞ	
UNF	DİN:223
SOL	
1/2x20	€ 31,80

KALIN DİŞ	
UNC	DİN:223
1/2x13	€ 18,50
1,1/2x6	€ 64,70

İNCE DİŞ	
BSF	
3/16x32	€ 11,20
7/8x11	€ 43,90

BORU DİŞ	
G-BSP	DİN:5158
1/8x28	€ 16,60
1/4x19	€ 16,90
3/8x19	€ 22,50
1/2x14	€ 22,50
5/8x14	€ 40,70
3/4x14	€ 40,70
7/8x14	€ 54,60
1x11	€ 54,60
1,1/8x11	€ 92,00
1,1/4x11	€ 92,00
1,3/8x11	€ 160,50
1,1/2x11	€ 160,50

EL KILAVUZLARI



METRİK DİŞ		
MM	3'lü	Din:352
2x04		€ 14,10
2,5x0,45		€ 14,10
2,6x0,45		€ 14,10
3x0,5		€ 7,20
3,5x0,6		€ 10,50
4x0,7		€ 7,20
5x0,8		€ 8,10
6x1		€ 8,10
7x1		€ 13,20
8x1,25		€ 10,50
10x1,5		€ 13,80
12x1,75		€ 18,00
14x2		€ 20,70
16x2		€ 25,80
18x2,5		€ 33,90
20x2,5		€ 39,00
22x2,5		€ 48,30
24x3		€ 60,00
27x3		€ 93,00
30x3,5		€ 126,00
33x3,5		€ 162,00
36x4		€ 192,00
42x4,5		€ 276,00
SOL		
3x0,5		€ 12,60
4x0,7		€ 12,60
5x0,8		€ 14,40
6x1		€ 15,00
8x1,25		€ 17,10
10x1,5		€ 23,40
12x1,75		€ 30,60
14x2		€ 33,90
16x2		€ 42,30
18x2,5		€ 54,90
20x2,5		€ 61,50
22x2,5		€ 75,00
24x3		€ 105,00
27x3		€ 168,00
30x3,5		€ 204,00
33x3,5		€ 252,00

KALIN DİŞ		
UNC	3'lü	Din:352
10x24		€ 13,50
1/4x20		€ 13,50
3/8x16		€ 16,80
1/2x13		€ 25,80
1,1/2x6		€ 202,20

METRİK İNCE DİŞ		
Mf	2'li	Din:2181
3x0,35		€ 14,40
4x0,5		€ 14,40
5x0,5		€ 14,40
6x0,75		€ 12,80
8x0,75		€ 12,80
8x1		€ 12,80
9x0,75		€ 14,40
9x1		€ 14,40
10x1		€ 12,80
10x1,25		€ 14,40
11x1		€ 18,60
12x0,75		€ 18,60
12x1		€ 18,60
12x1,25		€ 18,60
12x1,5		€ 17,00
13x1,5		€ 28,40
14x1		€ 28,40
14x1,25		€ 21,40
14x1,5		€ 18,40
16x1		€ 31,40
16x1,5		€ 22,40
18x1		€ 34,40
18x1,5		€ 25,80
18x2		€ 34,40
20x1		€ 43,20
20x1,5		€ 31,40
20x2		€ 43,20
22x1		€ 44,80
22x1,5		€ 44,80
22x2		€ 44,80
24x1,5		€ 47,00
24x2		€ 60,00
25x1,5		€ 88,00
27x1,5		€ 88,00
28x1,5		€ 104,00
28x2		€ 104,00
29x1,5		€ 104,00
30x1,5		€ 122,00
30x2		€ 122,00
32x1,5		€ 122,00
32x2		€ 122,00
33x1,5		€ 122,00
36x1,5		€ 157,00
SOL		
10x1		€ 19,00

İNCE DİŞ		
BSF	2'li	
3/16x32		€ 9,00
7/8x11		€ 45,00

KALIN DİŞ		
BSW	3'lü	Din:352
1/8x40		€ 13,80
5/32x32		€ 13,80
3/16x24		€ 13,50
1/4x20		€ 13,50
5/16x18		€ 15,00
3/8x16		€ 16,80
7/16x14		€ 21,30
1/2x12		€ 25,80
9/16x12		€ 33,60
5/8x11		€ 37,80
3/4x10		€ 50,70
7/8x9		€ 67,50
1x8		€ 77,70
1,1/8x7		€ 119,70
1,1/4x7		€ 134,70
1,3/8x6		€ 175,20
1,1/2x6		€ 202,20

İNCE DİŞ		
UNF	2'li	Din:2181
8-36		€ 9,00
10-32		€ 9,00
1/4x28		€ 9,00
5/16x24		€ 10,00
3/8x24		€ 11,20
7/16x20		€ 14,20
1/2x20		€ 17,20
9/16x18		€ 22,40
5/8x18		€ 25,20
3/4x16		€ 33,80
7/8x14		€ 45,00
1x12		€ 51,80
1x14		€ 56,00
1,1/8x12		€ 79,80
1,1/4x12		€ 99,80
1,3/8x12		€ 116,80
1,1/2x12		€ 134,80

BORU DİŞ		
G-BSP	2'li	Din:5157
1/8x28		€ 11,80
1/4x19		€ 13,20
3/8x19		€ 19,20
1/2x14		€ 27,40
5/8x14		€ 38,80
3/4x14		€ 38,80
7/8x14		€ 65,20
1x11		€ 65,20
1,1/8x11		€ 114,00
1,1/4x11		€ 114,00
1,3/8x11		€ 156,00
1,1/2x11		€ 156,00
3x11		€ 2.148,00

MAKİNE KILAVUZLARI



METRİK DİŞ

MM	DÜZ	HELİS	SON
2-10mm	Din:371	Din:371	Din:352
12-42mm	Din:376	Din:376	
2x0,4	€ 8,40	€ 9,00	
2,5x0,45	€ 8,40	€ 9,00	
3x0,5	€ 6,00	€ 7,60	€ 4,00
3,5x0,6	€ 6,70	€ 8,30	
4x0,7	€ 6,00	€ 7,60	€ 4,00
5x0,8	€ 6,40	€ 8,40	€ 4,30
6x1	€ 6,40	€ 8,40	€ 4,60
8x1,25	€ 8,00	€ 10,20	€ 5,50
10x1,5	€ 10,00	€ 12,80	€ 6,60
12x1,75	€ 11,80	€ 15,00	€ 9,50
14x2	€ 15,50	€ 19,30	€ 12,60
16x2	€ 17,10	€ 21,40	€ 17,40
18x2,5	€ 27,60	€ 31,80	€ 21,60
20x2,5	€ 38,40	€ 42,00	€ 24,00
22x2,5	€ 42,00	€ 55,20	€ 34,20
24x3	€ 45,60	€ 57,60	€ 37,40
27x3	€ 72,00	€ 93,60	
30x3,5	€ 76,80	€ 98,40	
33x3,5	€ 108,00	€ 140,40	
36x4	€ 176,00	€ 222,00	
42x4,5	€ 261,00	€ 336,00	

KALIN DİŞ

BSW	DÜZ	HELİS	SON
1/8-1/2	Din:371	Din:371	Din:352
9/16-1.1/2	Din:376	Din:376	
1/8x40	€ 10,30	€ 12,80	€ 4,60
5/32x32	€ 10,30	€ 12,80	€ 4,60
3/16x24	€ 10,30	€ 12,80	€ 4,50
1/4x20	€ 10,30	€ 12,80	€ 4,50
5/16x18	€ 13,10	€ 16,10	€ 5,00
3/8x16	€ 14,60	€ 17,60	€ 5,60
7/16x14	€ 17,40	€ 21,70	€ 7,10
1/2x12	€ 17,40	€ 21,70	€ 8,60
9/16x12	€ 26,50	€ 32,00	€ 11,20
5/8x11	€ 26,50	€ 32,00	€ 12,60
3/4x10	€ 51,60	€ 63,80	€ 16,90
7/8x9	€ 62,40	€ 78,00	€ 22,50
1x8	€ 70,80	€ 87,60	€ 25,90
1,1/4x7	€ 99,00	€ 111,60	
1,3/8x6	€ 206,40	€ 243,60	
1,1/2x6	€ 206,40	€ 243,60	

KALIN DİŞ

UNC	DÜZ	HELİS	SON
	Din:376	Din:376	Din:352
3/8x16	€ 14,60	€ 17,60	€ 5,60
1/2x13	€ 17,40	€ 21,70	€ 8,60

METRİK İNCE DİŞ

Mf	DÜZ	HELİS	SON
	Din:374	Din:374	Din:2181
5x0,5	€ 13,10	€ 14,80	
6x0,75	€ 13,10	€ 14,80	€ 6,40
8x0,75	€ 13,10	€ 14,80	€ 6,40
8x1	€ 13,10	€ 14,80	€ 6,40
10x1	€ 15,10	€ 17,40	€ 6,40
10x1,25	€ 15,10	€ 17,40	€ 7,20
11x1			€ 9,30
12x1	€ 20,80	€ 22,50	€ 9,30
12x1,25	€ 20,80	€ 22,50	€ 9,30
12x1,5	€ 20,80	€ 22,50	€ 8,50
14x1	€ 26,80	€ 27,50	€ 14,20
14x1,25	€ 26,80	€ 27,50	€ 10,70
14x1,5	€ 26,80	€ 27,50	€ 9,20
16x1	€ 30,00	€ 31,90	
16x1,5	€ 30,00	€ 31,90	€ 11,20
18x1	€ 40,80	€ 45,50	€ 17,20
18x1,5	€ 40,80	€ 45,50	€ 12,90
18x2	€ 40,80	€ 45,50	
20x1	€ 45,60	€ 50,40	
20x1,5	€ 45,60	€ 50,40	€ 15,70
20x2	€ 45,60	€ 50,40	€ 21,60
22x1,5	€ 55,20	€ 61,20	€ 22,40
22x2	€ 55,20	€ 61,20	€ 22,40
24x1	€ 64,80		
24x1,5	€ 64,80	€ 73,20	€ 23,50
24x2	€ 64,80	€ 73,20	€ 30,00
25x1	€ 68,40	€ 77,00	
26x1,5	€ 68,40	€ 77,00	€ 43,90
28x1,5	€ 82,00	€ 88,00	€ 51,90
28x2	€ 82,00	€ 88,00	
30x1,5	€ 92,40	€ 101,00	€ 61,00
30x2	€ 92,40	€ 101,00	€ 61,00
32x1,5	€ 113,00	€ 125,00	€ 61,00
32x2	€ 113,00	€ 125,00	
33x1,5	€ 113,00	€ 125,00	
33x2	€ 113,00	€ 125,00	
36x1,5	€ 142,00	€ 159,00	
42x2	€ 188,00	€ 207,00	

KONİK BORU DİŞ

NPT	DÜZ	HELİS	SON
1/8x27	€ 20,20		€ 13,90
1/4x18	€ 25,20		€ 15,50
3/8x18	€ 31,60		€ 21,40
1/2x14	€ 44,40		€ 26,80
3/4x14	€ 67,20		€ 35,80
1x11,5	€ 96,00		€ 56,20
1,1/4x11,5			€ 85,60
1,1/2x11,5			€ 160,50

MAKİNE KILAVUZLARI



İNCE DİŞ			
UNF	DÜZ	HELİS	SON
1/4-3/8 7/16-1.1/2	Din:371 Din:376	Din:371 Din:376	Din:352
10-32	€ 10,30	€ 12,80	
1/4x28	€ 10,30	€ 12,80	€ 4,50
5/16x24	€ 13,10	€ 16,10	€ 5,00
3/8x24	€ 14,60	€ 17,60	€ 5,60
7/16x20	€ 17,40	€ 21,70	€ 7,10
1/2x20	€ 17,40	€ 21,70	€ 8,60
9/16x18	€ 26,50	€ 32,00	€ 11,20
5/8x18	€ 26,50	€ 32,00	€ 12,60
3/4x16	€ 51,60	€ 63,80	€ 16,90
7/8x14	€ 62,40	€ 78,00	€ 22,50
1x12	€ 70,80	€ 87,60	€ 25,90
1x14	€ 70,80	€ 87,60	
1.1/4x12	€ 99,00	€ 111,60	
1.1/2x12	€ 206,40	€ 243,60	

BORU DİŞ			
G-BSP	DÜZ	HELİS	SON
	Din:5156	Din:5156	Din:5157
1/8x28	€ 16,10	€ 18,50	€ 5,90
1/4x19	€ 19,80	€ 23,40	€ 6,60
3/8x19	€ 24,00	€ 30,00	€ 9,60
1/2x14	€ 35,30	€ 42,00	€ 13,70
5/8x14	€ 39,60	€ 49,20	
3/4x14	€ 52,30	€ 62,40	€ 19,40
7/8x14	€ 65,20	€ 76,80	
1x11	€ 75,60	€ 96,00	€ 32,60
1.1/8x11	€ 105,60	€ 140,40	
1.1/4x11	€ 144,00	€ 168,00	€ 56,70
1.3/8x11	€ 168,00	€ 220,80	
1.1/2x11	€ 199,20	€ 240,00	€ 77,60
1.3/4x11	€ 261,60	€ 345,60	€ 155,20
3x11			€ 1.074,00

PLASTİK DİŞİ			
PG	DÜZ	HELİS	SON
			Din:40430
PG.11x18			€ 24,70

TİTANYUM KAPLI	
METRİK DİŞ	
MM	DÜZ
2-10mm 12-42mm	Din:371 Din:376
4x0,7	€ 9,80
5x0,8	€ 10,20
6x1	€ 10,70
8x1,25	€ 13,30
10x1,5	€ 17,00
12x1,75	€ 22,60
METRİK İNCE DİŞ	
Mf	DÜZ
2-10mm 12-42mm	Din:371 Din:376
10x1,25	€ 19,70

SOMUN İÇİN	
METRİK DİŞ	
MM	DÜZ
2-10mm 12-42mm	Din:371 Din:376
6x1	€ 17,60
10x1,5	€ 26,40
14x2	€ 46,60
KALIN DİŞ	
BSW	DÜZ
1/8-1/2 9/16-1.1/2	Din:371 Din:376
3/8x16	€ 35,70
7/16x14	€ 42,40
5/8x11	€ 64,60
İNCE DİŞ	
UNF	DÜZ
1/4-3/8 7/16-1.1/2	Din:371 Din:376
1/4x28	€ 25,10
1/2x20	€ 42,40
BORU DİŞ	
G-BSP	DÜZ
	Din:5156
1/2x14	€ 85,90



KOMBİ	
METRİK DİŞ	
MM	Din:13
3x0,5	€ 19,40
4x0,7	€ 19,40
5x0,8	€ 19,40
6x1	€ 21,60
8x1,25	€ 24,70
10x1,5	€ 27,10
12x1,75	€ 31,80

ATLAMALI DİŞ	
METRİK DİŞ	
MM	Din:371 Din:376
2-10mm 12-42mm	Din:371 Din:376
M.10	€ 16,60
M.14	€ 25,80
M.18	€ 39,00

HELİ-COİL TAKIMLAR



MM

B5101

€ 157,50

3-12

m3-4-5-6-8-10-12

Takıcı (7)-Kırıcı (7)-Matkap ucu (7)

Yay/Adet 15-15-15-15-15-10-10

B5104

€ 153,90

5-12

m5-6-8-10-12

Takıcı (5)-Kırıcı (5)-Matkap ucu (5)

Yay/Adet 15-15-15-10-10

B5131

€ 82,40

5-8

m5-6-8

Takıcı (3)-Kırıcı (3)-Matkap ucu (3)

Yay/Adet 15-15-15

B5130

€ 93,40

6-10

m6-8-10

Takıcı (3)-Kırıcı (3)-Matkap ucu (3)

Yay/Adet 15-15-10

Tapa

B5116

€ 173,00

6-14x1,5 (Tapa için)

m6-8-10-12-14x1,5

Takıcı (5)-Kırıcı (4)

Yay/Adet 15-15-10-10-10

Buji

B5108

€ 178,50

6-14x1,25 (Buji için)

m6-8-10-12-14x1,25

Takıcı (5)-Kırıcı (4)-Matkap ucu (4)

Yay/Adet 15-15-10-10-10

HELİ-COİL TAKIMLAR



BSW

B5122

€ 194,70

1/4"-1/2"

1/4-5/16-3/8-7/16-1/2

Takıcı (5)-Kırıcı (5)-Matkap ucu (5)

Yay/Adet 25-25-25-10-10

UNC

B5120

€ 182,70

1/4"-1/2"

1/4-5/16-3/8-7/16-1/2

Takıcı (5)-Kırıcı (5)-Matkap ucu (5)

Yay/Adet 25-25-25-10-10

UNF

B5121

€ 182,70

1/4"-1/2"

1/4-5/16-3/8-7/16-1/2

Takıcı (5)-Kırıcı (5)-Matkap ucu (5)

Yay/Adet 25-25-25-10-10

BSF

B5123

€ 198,50

1/4"-1/2"

1/4-5/16-3/8-7/16-1/2

Takıcı (5)-Kırıcı (5)-Matkap ucu (5)

Yay/Adet 25-25-25-10-10

G-BSP

B5124

€ 237,30

1/8"-1/2"

1/8-1/4-3/8-1/2

Takıcı (4)-Kırıcı (2)-Matkap ucu (3)

Yay/Adet 5-5-5-5-5

NPT

B5126

€ 412,40

1/8"-1/2"

1/8-1/4-3/8-1/2

Takıcı (4)

Yay/Adet 5-5-5-5-5

HELİ-COİL TAMİR TAKIMLARI



2x0,4	B4001	€ 22,60
-------	-------	---------

Takıcı-Kırıcı-Matkap ucu-Yay (20)

3x0,5	B4005	€ 21,60
-------	-------	---------

Takıcı-Kırıcı-Matkap ucu-Yay (20)

4x0,7	B4007	€ 21,60
-------	-------	---------

Takıcı-Kırıcı-Matkap ucu-Yay (20)

5x0,8	B4009	€ 21,60
-------	-------	---------

Takıcı-Kırıcı-Matkap ucu-Yay (20)

6x1	B4010	€ 24,30
-----	-------	---------

Takıcı-Kırıcı-Matkap ucu-Yay (20)

8x1	B4013	€ 30,90
-----	-------	---------

Takıcı-Kırıcı-Matkap ucu-Yay (20)

8x1,25	B4012	€ 30,90
--------	-------	---------

Takıcı-Kırıcı-Matkap ucu-Yay (20)

10x1	B4018	€ 33,00
------	-------	---------

Takıcı-Kırıcı-Matkap ucu-Yay (15)

10x1,25	B4017	€ 33,00
---------	-------	---------

Takıcı-Kırıcı-Matkap ucu-Yay (15)

10x1,5	B4016	€ 33,00
--------	-------	---------

Takıcı-Kırıcı-Matkap ucu-Yay (15)

12x1,25	B4023	€ 37,00
---------	-------	---------

Takıcı-Kırıcı-Matkap ucu-Yay (10)

12x1,5	B4022	€ 37,00
--------	-------	---------

Takıcı-Kırıcı-Matkap ucu-Yay (10)

12x1,75	B4021	€ 37,00
---------	-------	---------

Takıcı-Kırıcı-Matkap ucu-Yay (10)

14x1,5	B4029	€ 41,40
--------	-------	---------

Takıcı-Kırıcı-Matkap ucu-Yay (10)

14x2	B4028	€ 41,40
------	-------	---------

Takıcı-Kırıcı-Matkap ucu-Yay (10)

16x2	B4032	€ 50,10
------	-------	---------

Takıcı-Yay (10)

18x1,5	B4036	€ 59,40
--------	-------	---------

Takıcı-Yay (5)

18x2,5	B4034	€ 59,40
--------	-------	---------

Takıcı-Yay (5)

20x1,5	B4039	€ 64,40
--------	-------	---------

Takıcı-Yay (5)

20x2,5	B4037	€ 64,40
--------	-------	---------

Takıcı-Yay (5)

22x2,5	B4040	€ 74,10
--------	-------	---------

Takıcı-Yay (5)

24x3	B4043	€ 85,50
------	-------	---------

Takıcı-Yay (5)

HELİ-COİL BUJİ TAMİR TAKIMLARI



12x1,25	ZKG012	€ 44,10
---------	--------	---------

Takıcı-Yay (15)

14x1,25	ZKG014	€ 52,50
---------	--------	---------

Takıcı-Yay (15)

BaerCoil Uygulaması

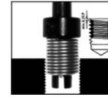
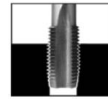

1-DELME

Hasarlı dişi uygun ölçüdeki matkapla delin.(Setler uygun ölçü matkapları içermektedir.)

2-DİŞ AÇMA

Delinen yeni yuvaya BaerCoil kılavuzu ile yeni bir diş çekin.Bu işlem esnasında diş açma yağı kullanınız.

3-BAERCOİL MONTAJI

Takıcıya yerleştirdiğiniz BaerCoil yayı yuvayı ortalarak ve hafifçe bastırarak çevirin.

4-SONLANDIRMA

Yerleştirme işlemi tamamlandığında kırıcı aparatla BaerCoil'in içindeki sıkı için tuttuğunuz parçayı bastırarak kırınız.Kırdığınız bu parçayı bir pense yada kargaburun yardımıyla alınız.

HELİ-COİL TEK KILAVUZLAR



METRİK-İNCE DİŞ	
MM-Mf	SON
2x0,4	€ 7,40
2,5x0,45	€ 7,40
3x0,5	€ 6,50
3,5x0,6	€ 6,50
4x0,7	€ 6,50
5x0,8	€ 6,50
6x1	€ 6,50
7x1	€ 8,10
8x1	€ 8,10
8x1,25	€ 8,10
9x1,25	€ 10,00
10x1	€ 10,00
10x1,25	€ 10,00
10x1,5	€ 10,00
11x1,5	€ 11,20
12x1	€ 13,70
12x1,25	€ 13,70
12x1,5	€ 13,70
12x1,75	€ 11,20
14x1	€ 15,60
14x1,25	€ 15,60
14x1,5	€ 15,60
14x2	€ 15,60
16x1,5	€ 19,70
16x2	€ 19,70
18x1,5	€ 24,60
18x2	€ 24,60
18x2,5	€ 24,60
20x1,5	€ 27,30
20x2	€ 27,30
20x2,5	€ 27,30
22x1,5	€ 31,50
22x2	€ 31,50
22x2,5	€ 31,50
24x1,5	€ 39,70
24x2	€ 39,70
24x3	€ 39,70

KALIN DİŞ	
BSW	SON
1/8x40	€ 6,40
3/16x24	€ 6,40
1/4x20	€ 6,40
5/16x18	€ 7,10
3/8x16	€ 7,40
7/16x14	€ 9,80
1/2x12	€ 11,20
9/16x12	€ 18,60
5/8x11	€ 23,00
11/16x11	€ 28,00
3/4x10	€ 28,00
7/8x9	€ 40,40
1"x8	€ 40,40

İNCE DİŞ	
UNF	SON
4x48	€ 9,80
6x40	€ 9,80
8x36	€ 9,80
10x32	€ 9,80
1/4x28	€ 6,40
5/16x24	€ 7,10
3/8x24	€ 7,40
7/16x20	€ 9,80
1/2x20	€ 11,20
9/16x18	€ 18,60
5/8x18	€ 23,00
3/4x16	€ 28,00
7/8x14	€ 40,40
1"x12	€ 40,40
1"x14	€ 40,40

KALIN DİŞ	
UNC	SON
2x56	€ 9,80
4x40	€ 9,80
5x40	€ 9,80
6x32	€ 9,80
8x32	€ 9,80
10x24	€ 9,80
12x24	€ 9,80
1/4x20	€ 6,40
5/16x18	€ 7,10
3/8x16	€ 7,40
7/16x14	€ 9,80
1/2x13	€ 11,20
9/16x12	€ 18,60
5/8x11	€ 23,00
3/4x10	€ 28,00
7/8x9	€ 40,40
1"x8	€ 40,40

BORU DİŞ	
G-BSP	SON
1/8x28	€ 18,60
1/4x19	€ 23,50
3/8x19	€ 30,60
1/2x14	€ 49,90
5/8x14	€ 73,40
3/4x14	€ 73,40
1"x11	€ 116,80

HELİ-COİL 2'Lİ KILAVUZLAR



METRİK-İNCE DİŞ	
MM-Mf	2'li
26x1,5	€ 130,50
27x1,5	€ 130,50
27x2	€ 130,50
27x3	€ 130,50
28x1,5	€ 130,50
30x1,5	€ 171,20
30x2	€ 171,20
30x3,5	€ 171,20
33x2	€ 177,60
33x3,5	€ 177,60
36x1,5	€ 198,00
36x2	€ 198,00
36x3	€ 198,00
36x4	€ 198,00

KALIN DİŞ	
UNC	2'li
1.1/8x7	€ 123,10
1.1/4x7	€ 147,70
1.3/8x6	€ 176,60
1.1/2x6	€ 236,50

İNCE DİŞ	
UNF	2'li
1.1/8x12	€ 123,10
1.1/4x12	€ 147,70
1.3/8x12	€ 176,60
1.1/2x12	€ 236,50

BAER

HELI-COIL YAYLAR



MM-Mf	Paket Adedi	1.D	1,5.D	2.D	2,5.D	3.D
2x0,4	100	€ 0,52	€ 0,67	€ 0,78	€ 0,88	€ 1,10
2,2x0,45	100	€ 0,52	€ 0,67	€ 0,78	€ 0,88	€ 1,10
2,5x0,45	100	€ 0,15	€ 0,17	€ 0,18	€ 0,21	€ 0,25
3x0,5	100	€ 0,15	€ 0,17	€ 0,18	€ 0,21	€ 0,25
3,5x0,6	100	€ 0,18	€ 0,19	€ 0,20	€ 0,23	€ 0,28
4x0,7	100	€ 0,15	€ 0,17	€ 0,18	€ 0,21	€ 0,23
5x0,8	100	€ 0,18	€ 0,14	€ 0,20	€ 0,24	€ 0,29
6x1	100	€ 0,19	€ 0,15	€ 0,23	€ 0,28	€ 0,34
7x1	100	€ 0,21	€ 0,25	€ 0,28	€ 0,33	€ 0,40
8x1	100	€ 0,23	€ 0,23	€ 0,28	€ 0,33	€ 0,40
8x1,25	100	€ 0,20	€ 0,20	€ 0,28	€ 0,33	€ 0,40
9x1,25	100	€ 0,28	€ 0,37	€ 0,37	€ 0,41	€ 0,48
10x1	100	€ 0,25	€ 0,28	€ 0,32	€ 0,39	€ 0,46
10x1,25	100	€ 0,25	€ 0,28	€ 0,32	€ 0,39	€ 0,46
10x1,5	100	€ 0,25	€ 0,28	€ 0,32	€ 0,39	€ 0,46
11x1,5	100	€ 0,42	€ 0,47	€ 0,51	€ 0,62	€ 0,69
12x1	100	€ 0,37	€ 0,43	€ 0,48	€ 0,57	€ 0,69
12x1,25	100	€ 0,37	€ 0,43	€ 0,48	€ 0,57	€ 0,69
12x1,5	100	€ 0,37	€ 0,43	€ 0,48	€ 0,57	€ 0,69
12x1,75	100	€ 0,37	€ 0,43	€ 0,48	€ 0,57	€ 0,69
14x1	50	€ 0,64	€ 0,66	€ 0,76	€ 0,92	€ 1,10
14x1,25	50	€ 0,53	€ 0,61	€ 0,63	€ 0,76	€ 0,92
14x1,5	50	€ 0,53	€ 0,61	€ 0,63	€ 0,76	€ 0,92
14x2	50	€ 0,53	€ 0,61	€ 0,63	€ 0,76	€ 0,92
16x1,5	50	€ 0,72	€ 0,75	€ 0,92	€ 1,01	€ 1,10
16x2	50	€ 0,72	€ 0,75	€ 0,92	€ 1,01	€ 1,10
18x1,5	25	€ 1,05	€ 1,21	€ 1,65	€ 1,87	€ 2,20
18x2	25	€ 1,05	€ 1,21	€ 1,65	€ 1,87	€ 2,20
18x2,5	25	€ 1,05	€ 1,21	€ 1,65	€ 1,87	€ 2,20
20x1,5	25	€ 1,21	€ 1,54	€ 1,98	€ 2,20	€ 2,53
20x2	25	€ 1,21	€ 1,54	€ 1,98	€ 2,20	€ 2,53
20x2,5	25	€ 1,21	€ 1,54	€ 1,98	€ 2,20	€ 2,53
22x1,5	25	€ 1,32	€ 1,65	€ 2,09	€ 2,42	€ 2,75
22x2	25	€ 1,32	€ 1,65	€ 2,09	€ 2,42	€ 2,75
22x2,5	25	€ 1,32	€ 1,65	€ 2,09	€ 2,42	€ 2,75
24x1,5	25	€ 1,65	€ 1,76	€ 2,20	€ 2,64	€ 3,08
24x2	25	€ 1,65	€ 1,76	€ 2,20	€ 2,64	€ 3,08
24x3	25	€ 1,65	€ 1,76	€ 2,20	€ 2,64	€ 3,08

Buji	Paket Adedi	8,4mm	12,4mm	16,4mm
M.14x1,25	50	€ 0,61	€ 0,61	€ 0,61

BSW	Paket Adedi	1.D	1,5.D	2.D	2,5.D	3.D
1/8x40	100	€ 0,61	€ 0,70	€ 1,10	€ 1,24	€ 1,33
3/16x24	100	€ 0,61	€ 0,70	€ 1,10	€ 1,24	€ 1,33
1/4x20	100	€ 0,26	€ 0,29	€ 0,33	€ 0,44	€ 0,47
5/16x18	100	€ 0,31	€ 0,35	€ 0,39	€ 0,46	€ 0,56
3/8x16	100	€ 0,54	€ 0,58	€ 0,68	€ 0,80	€ 0,97
7/16x14	100	€ 0,66	€ 0,73	€ 0,84	€ 0,99	€ 1,21
1/2x12	100	€ 0,66	€ 0,73	€ 0,84	€ 0,99	€ 1,21
9/16x12	50	€ 1,65	€ 2,31	€ 2,72	€ 3,23	€ 3,96
5/8x11	50	€ 1,65	€ 2,31	€ 2,72	€ 3,23	€ 3,96
3/4x10	25	€ 2,13	€ 2,75	€ 3,36	€ 4,03	€ 4,83
7/8x9	10	€ 2,75	€ 3,85	€ 4,81	€ 5,79	€ 6,94
1"x8	10	€ 2,97	€ 4,40	€ 4,81	€ 5,79	€ 6,94
1.1/8x7	10	€ 9,33	€ 11,28	€ 15,32		
1.1/4x7	10	€ 10,52	€ 13,83	€ 18,43		
1.3/8x6	10		€ 37,33			
1.1/2x6	10	€ 20,23	€ 28,44	€ 34,48		

HELI-COIL YAYLAR



UNC	Paket Adedi	1.D	1,5.D	2.D	2,5.D	3.D
2x56	100	€ 0,52	€ 0,61	€ 0,78	€ 0,88	€ 1,10
4x40	100	€ 0,20	€ 0,19	€ 0,20	€ 0,23	€ 0,28
5x40	100	€ 0,21	€ 0,22	€ 0,23	€ 0,28	€ 0,33
6x32	100	€ 0,15	€ 0,18	€ 0,19	€ 0,21	€ 0,24
8x32	100	€ 0,15	€ 0,18	€ 0,19	€ 0,21	€ 0,24
10x24	100	€ 0,20	€ 0,20	€ 0,22	€ 0,26	€ 0,32
12x24	100	€ 0,21	€ 0,23	€ 0,25	€ 0,31	€ 0,37
1/4x20	100	€ 0,21	€ 0,23	€ 0,25	€ 0,31	€ 0,37
5/16x18	100	€ 0,28	€ 0,33	€ 0,35	€ 0,42	€ 0,51
3/8x16	100	€ 0,43	€ 0,43	€ 0,56	€ 0,64	€ 0,76
7/16x14	100	€ 0,47	€ 0,57	€ 0,65	€ 0,77	€ 0,95
1/2x13	100	€ 0,51	€ 0,57	€ 0,65	€ 0,77	€ 0,95
9/16x12	50	€ 1,65	€ 2,20	€ 2,83	€ 3,23	€ 3,91
5/8x11	50	€ 1,50	€ 2,00	€ 2,49	€ 2,98	€ 3,55
3/4x10	25	€ 1,74	€ 2,37	€ 2,95	€ 3,50	€ 4,19
7/8x9	10	€ 2,31	€ 3,47	€ 4,40	€ 5,20	€ 6,31
1"x8	10	€ 2,31	€ 3,47	€ 4,40	€ 5,20	€ 6,31

UNF	Paket Adedi	1.D	1,5.D	2.D	2,5.D	3.D
4x48	100	€ 0,46	€ 0,53	€ 0,70	€ 0,78	€ 0,99
6x40	100	€ 0,46	€ 0,53	€ 0,70	€ 0,78	€ 0,99
8x36	100	€ 0,46	€ 0,53	€ 0,70	€ 0,78	€ 0,99
10x32	100	€ 0,20	€ 0,21	€ 0,25	€ 0,31	€ 0,37
1/4x28	100	€ 0,20	€ 0,21	€ 0,25	€ 0,31	€ 0,37
5/16x24	100	€ 0,28	€ 0,30	€ 0,35	€ 0,42	€ 0,51
3/8x24	100	€ 0,41	€ 0,43	€ 0,52	€ 0,63	€ 0,76
7/16x20	100	€ 0,51	€ 0,57	€ 0,65	€ 0,77	€ 0,95
1/2x20	100	€ 0,51	€ 0,57	€ 0,65	€ 0,77	€ 0,95
9/16x18	50	€ 1,20	€ 1,20	€ 1,44	€ 1,65	€ 2,02
5/8x18	50	€ 1,20	€ 1,20	€ 1,44	€ 1,65	€ 2,02
3/4x16	25	€ 1,98	€ 2,75	€ 3,32	€ 4,03	€ 4,83
7/8x14	10	€ 2,68	€ 3,96	€ 5,04	€ 5,79	€ 6,94
1"x12	10	€ 2,68	€ 3,96	€ 5,04	€ 5,79	€ 6,94

BSF	Paket Adedi	1.D	1,5.D	2.D	2,5.D	3.D
3/16x32	100	€ 0,61	€ 0,70	€ 1,10	€ 1,24	€ 1,33
1/4x26	100	€ 0,26	€ 0,29	€ 0,33	€ 0,40	€ 0,47
5/16x22	100	€ 0,29	€ 0,35	€ 0,39	€ 0,46	€ 0,56
3/8x20	100	€ 0,54	€ 0,58	€ 0,68	€ 0,80	€ 0,97
7/16x18	100	€ 0,66	€ 0,73	€ 0,84	€ 0,99	€ 1,21
1/2x16	100	€ 0,66	€ 0,73	€ 0,84	€ 0,99	€ 1,21
9/16x16	100	€ 1,65	€ 2,20	€ 2,72	€ 3,23	€ 3,96
5/8x14	50	€ 1,65	€ 2,20	€ 2,72	€ 3,23	€ 3,96
3/4x12	50	€ 2,13	€ 2,75	€ 3,36	€ 4,03	€ 4,83
7/8x11	25	€ 2,75	€ 3,85	€ 4,81	€ 5,79	€ 6,94
1"x10	10	€ 2,75	€ 3,85	€ 4,81	€ 5,79	€ 6,94

G-BSP	Paket Adedi	1,5.D
1/8x28	100	€ 0,44
1/4x19	100	€ 0,66
3/8x19	50	€ 0,77
1/2x14	25	€ 0,99
5/8x14	10	€ 2,48
3/4x14	5	€ 2,48
7/8x14	5	€ 7,59
1"x11	5	€ 7,59

BETA

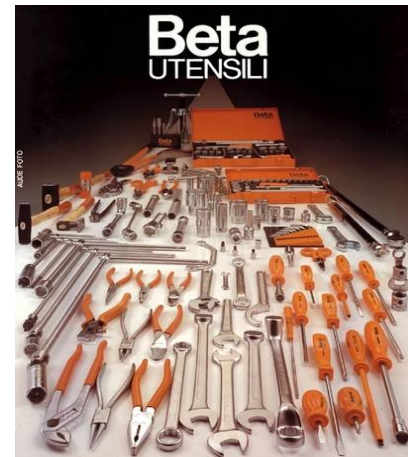
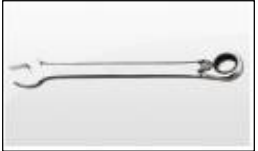

ORİJİNAL GÜNCEL BETA FİYAT KATALOĞUNU FİRMAMIZDAN İSTEYİNİZ.

LUPAMAT



TEK KADEMELİ PİSTONLU HAVA KOMPRESÖRLERİ				
Ürün Kodu	Basınç (bar)	Piston Deplas. (lt/dk)	Motor Gücü (Hp)	Depo Hacmi
LKD 41-300 Mono	8	200	1,5	50
LKD 61-330 A	8	370	3	200
LKD 61-440	8	535	4	200
LKD 61-550 A	8	900	7,5	500
LKD 61-555	8	1454	10	500

ÇİFT KADEMELİ PİSTONLU HAVA KOMPRESÖRLERİ				
Ürün Kodu	Basınç (bar)	Piston Deplas. (lt/dk)	Motor Gücü (Hp)	Depo Hacmi
LKD 62-520	15	400	4	200
LKD 62-553 A	15	741	7,5	500



AYDIN TRAFİ



TEK KADEMELİ PİSTONLU HAVA KOMPRESÖRLERİ				
Ürün Kodu	Basınç (bar)	Piston Deplas. (lt/dk)	Motor Gücü (Hp)	Depo Hacmi
11-50M	8	110	1-0,75	50
21-100	8	210	1,5-1,1	100
21-100M	8	210	1,5-1,1	100
21-130	8	275	2-1,5	130
21-130M	8	260	2-1,5	130
21-220	8	260	2-1,5	220
21-220M	8	260	2-1,5	220
21-300/4,0	8	530	4-3	300
21-300/5,5	8	760	5,5-4	300
21-530/5,5	8	760	5,5-4	530
21-530/7,5	8	900	7,5-5,5	530
21-530/10	8	1370	10-7,5	530
21-1000	8	1370	10-7,5	1000

ÇİFT KADEMELİ PİSTONLU HAVA KOMPRESÖRLERİ				
Ürün Kodu	Basınç (bar)	Piston Deplas. (lt/dk)	Motor Gücü (Hp)	Depo Hacmi
22-220	12	200	2-1,5	220
22-220M	12	200	2-1,5	220
22-300/5,5	12	630	5,5-4	300
22-530/5,5	12	630	5,5-4	530
22-530/7,5	12	800	7,5-5,5	530
22-530/10	12	1200	10-7,5	530
22-1000/15	12	1730	15-11	1000



SERVİSLER

MERKEZ SERVİS

SEVAN HIRDAVATÇILIK SAN.TİC.A.Ş.

Keresteci Fazıl Sok.No:10

0 (212) 249 30 00 - 249 49 24 -249 13 75 Fax:249 04 74

www.sevahirdavat.com.tr sevan@sevanhirdavat.com

KARAKÖY - İSTANBUL

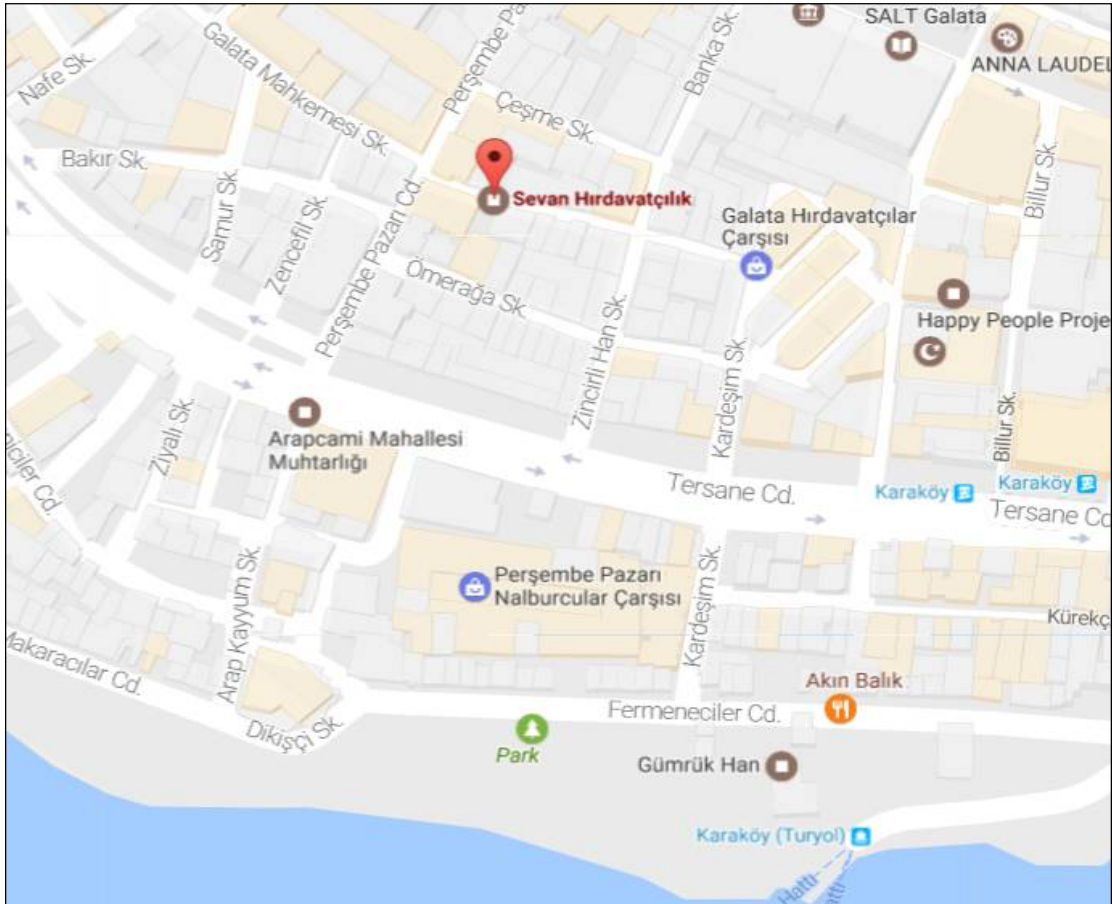

FAYDALI BİLGİLER

INCH-MM STANDART DIŞ SAYILARI VE MATKAP ÖLÇÜLERİ

ÖLÇÜ	BSW		UNC		UNF		BSF		GAS		NPT	
	Diş	Mat.	Diş	Mat.	Diş	Mat.	Diş	Mat.	Diş	Mat.	Diş	Mat.
Nr.0					80,00							
Nr.1			64,00	1,50	72,00							
Nr.2			56,00	1,80	64,00							
Nr.3			48,00	2,10	56,00							
Nr.4			40,00	2,35	48,00	2,40						
Nr.5			40,00	2,65	44,00	2,70						
Nr.6			32,00	2,85	40,00	2,95						
Nr.8			32,00	3,50	36,00	3,50						
Nr.10			24,00	4,50	32,00	4,10						
Nr.12			24,00	5,10	28,00	4,70						
1/16"	60,00	1,20							28,00		27,00	6,00-6,30
3/32"	48,00	1,90										
1/8"	40,00	2,55							28,00	8,80	27,00	8,40-8,70
5/32"	32,00	3,20										
3/16"	24,00	3,70					32,00	4,00				
7/32"	24,00	4,50					28,00	4,50				
1/4"	20,00	5,10	20,00	5,10	28,00	5,50	26,00	5,30	19,00	11,80	18,00	10,70-11,10
9/32"							26,00	6,10				
5/16"	18,00	6,50	18,00	6,60	24,00	6,90	22,00	6,80				
3/8"	16,00	7,90	16,00	8,00	24,00	8,50	20,00	8,30	19,00	15,25	18,00	14,25-14,50
7/16"	14,00	9,30	14,00	9,40	20,00	9,90	18,00	9,70				
1/2"	12,00	10,50	13,00	10,80	20,00	11,50	16,00	11,10	14,00	19,00	14,00	17,50-18,00
9/16"	12,00	12,10	12,00	12,20	18,00	12,90	16,00	12,70				
5/8"	11,00	13,50	11,00	13,50	18,00	14,50	14,00	14,00	14,00	21,00		
3/4"	10,00	16,25	10,00	16,50	16,00	17,50	12,00	16,75	14,00	24,50	14,00	22,75-23,25
7/8"	9,00	19,25	9,00	19,50	14,00	20,40	11,00	19,75	14,00	28,25		
1"	8,00	22,00	8,00	22,50	12,00	23,25	10,00	21,75	11,00	30,75	11,50	28,50-29
1.1/8"	7,00	24,75	7,00	25,00	12,00	26,50	9,00	22,50				
1.1/4"	7,00	28,00	7,00	28,00	12,00	29,50	9,00	28,50	11,00	39,50	11,50	37,50-38,50
1.3/8"	6,00	30,50	6,00	30,75	12,00	32,75	8,00	31,50				
1.1/2"	6,00	33,50	6,00	34,00	12,00	36,00	8,00	34,50	11,00	45,00	11,50	43,50-44,00
1.5/8"	5,00	35,50					8,00					
1.3/4"	5,00	39,00	5,00	39,50			7,00	41,00	11,00	51,00		
1.7/8"	4,50	41,50										
2"	4,50	44,50	4,50	45,00			7,00		11,00	57,00	11,50	55,00-56,00
2.1/4"	4,00	50,50	4,50	51,60			6,00		11,00	63,00		
2.1/2"	4,00	57,00	4,00	57,25			6,00		11,00	73,00	8,00	
2.3/4"	3,50	62,00	4,00	63,60			6,00					
3"	3,50	68,00	4,00	69,90			5,00		11,00	86,00	8,00	
3.1/4"	3,25		4,00	76,25			5,00					
3.1/2"	3,25		4,00	82,60			4,50				8,00	
3.3/4"	3,00		4,00	89,00			4,50					
4"	3,00		4,00	95,30			4,50	47,00	11,00		8,00	
4.1/4"							4,00					
5"									11,00		8,00	
6"									11,00		8,00	
8"											8,00	
10"											8,00	
12"											8,00	

ÖLÇÜ	MM	
	Diş	Mat.
1,00	0,25	0,75
1,10	0,25	0,85
1,20	0,25	0,95
1,40	0,30	1,10
1,60	0,35	1,25
1,80	0,35	1,45
2,00	0,40	1,60
2,20	0,45	1,75
2,50	0,45	2,05
3,00	0,50	2,50
3,50	0,60	2,90
4,00	0,70	3,30
4,50	0,75	3,70
5,00	0,80	4,20
6,00	1,00	5,00
7,00	1,00	6,00
8,00	1,25	6,80
9,00	1,25	7,80
10,00	1,50	8,50
11,00	1,50	9,50
12,00	1,75	10,20
14,00	2,00	12,00
16,00	2,00	14,00
18,00	2,50	15,50
20,00	2,50	17,50
22,00	2,50	19,50
24,00	3,00	21,00
27,00	3,00	21,00
30,00	3,50	26,50
33,00	3,50	29,50
36,00	4,00	32,00
39,00	4,00	35,00
42,00	4,50	37,50
45,00	4,50	40,50
48,00	5,00	43,00
52,00	5,00	47,00
56,00	5,50	50,50
60,00	5,50	54,50
64,00	6,00	58,00
68,00	6,00	62,00

INCH-MM ÇEVİRİM

INC	MM
1/32"	0,79
1/30"	0,85
1/20"	1,27
1/16"	1,59
5/64"	1,98
3/32"	2,38
7/64"	2,78
1/8"	3,18
9/64"	3,57
5/32"	3,97
3/16"	4,76
7/32"	5,76
1/4"	6,35
9/32"	7,14
5/16"	7,94
11/32"	8,73
3/8"	9,52
13/32"	10,32
7/16"	11,11
15/32"	11,91
1/2"	12,70
17/32"	13,49
9/16"	14,29
19/32"	15,08
5/8"	15,87
21/32"	16,67
11/16"	17,46
23/32"	18,26
3/4"	19,05
25/32"	19,84
13/16"	20,64
27/32"	21,43
7/8"	22,22
29/32"	23,02
15/16"	23,81
31/32"	24,61
1"	25,40
1.1/16"	26,99
1.1/8"	28,57
1.3/16"	30,16
1.1/4"	31,75
1.5/16"	33,34
1.3/8"	34,92
1.7/16"	36,51
1.1/2"	38,10
1.9/16"	39,69
1.5/8"	41,27
1.11/16"	42,86
1.3/4"	44,45
1.13/16"	46,04
1.7/8"	47,62
1.15/16"	49,21
2"	50,80
2.1/8"	53,97
2.1/4"	57,15
2.3/8"	60,32
2.1/2"	63,50
2.5/8"	66,67
2.3/4"	69,85
2.7/8"	73,02
3"	76,20
3.1/8"	79,37
3.1/4"	82,55
3.3/8"	85,72
3.1/2"	88,90
3.5/8"	92,07
3.3/4"	95,25
3.7/8"	98,42
3.29/32"	99,22
3.15/16"	100,01

TORK ÖLÇÜLERİ ÇEVİRİM TABLOSU

	kgcm	kgm	cNm	Nm	lbft	lbin
kgcm	1	0,01	9,8066	0,0980	0,0723	0,8679
kgm	100	1	980,665	9,8066	7,2330	86,7961
cNm	1019,71	10,1971	1	0,01	73,7562	885,074
Nm	10,1971	0,1019	100	1	0,7375	8,8507
lbft	13,8254	0,1382	135,581	1,3558	1	12
lbin	1,1521	0,0115	11,2984	0,1129	0,0833	1

MM CIVATALARIN ANAHTAR AĞIZ ÖLÇÜLERİ

Cıvata Ölçüsü	MM	Cıvata Ölçüsü	MM
1,6	3,2	22	32
2	4	24	36
2,5	5	27	41
3	5,5	30	46
4	7	33	50
5	8	36	55
6	10	39	60
7	11	42	65
8	13	45	70
10	17	48	75
12	19	52	80
14	22	56	85
16	24	60	90
18	27	64	95
20	30	68	100

BASINÇ ÖLÇÜLERİ ÇEVİRİM TABLOSU

	atm	at	psi	torr	bar
atm	1	1,0332	14,7	759,999	1,0133
at	0,9678	1	14,2233	735,559	0,9807
psi	0,068	0,07	1	51,7149	0,6894
torr	0,0013	0,0013	0,1933	1	0,0013
bar	0,9863	1,097	14,5038	750,061	1

GARANTİ ŞARTLARI

- 1- TÜKETİCİ: 4077 numaralı Tüketicinin Korunması Hakkındaki Kanunun 3.Maddesi "e" bendinde bir mal veya hizmeti ticari veya mesleki olmayan amaçlarla edinen, kullanan veya yararlanan gerçek veya tüzel kişi olarak tanımlanmaktadır. TÜKETİCİ olarak amatör kullanımlar için garanti süresi 2 (iki) yıldır.
- 2- PROFESYONEL KULLANICI ise alınan mal veya hizmeti ticari veya mesleki amaçlar için kullanan gerçek veya tüzel kişidir. Profesyonel amaçlı kullanımlar için ise garanti süresi 1 (bir) yıldır.
- 3- Garanti kapsamındaki talepler ancak Yetkili Servis'lerde karşılanır ve garantili tamir ve onarımlarının yapılabilmesi için kaşeli, imzalı garanti belgesi veya fatura ibrazı şarttır.
- 4- Malzeme veya imalat hatalarından kaynaklanan hasarlar, hatalı parçanın veya makinenin onarımı veya değiştirilmesi yoluyla telafi edilir. Diğer bakım ve kontroller ücretli olarak yapılır.
- 5- Malın garanti süresi içerisinde gerek malzeme ve işçilik, gerek se montaj hatalarından dolayı arızalanması halinde işçilik masrafı, değiştirilen parça bedeli ya da başka herhangi bir ad altında hiçbir ücret talep etmeksizin tamiri yapılacaktır.
- 6- Havalı aletler için, kullanıldığı hava tesisatına ait standarda uygunluk belgesi aranmaktadır.

GARANTİ KAPSAMINA GİRMİYEN HALLER

- * Garanti belgesi veya faturası ibraz edilemeyen ürünler,
- * Ürünün mevcut yıpranma durumu ile fatura tarihinin uyumlu olmaması, faturanın sonradan düzenlendiğinin tespit edildiği durumlar
- * Kullanım klavuzuna uyulmaması sonucu üründe meydana gelen arızalar,
- * Ürünün üzerinde değişiklik veya ilave yapılmasından kaynaklanan arızalar,
- * Yetkili servislerin dışındaki şahısların ürünü açmaları, müdahale etmeleri ve orijinal olmayan yedek parça kullanmaları sonucu oluşan arızalar,
- * Kullanıma bağlı veya doğal ömrünü tamamlayan parçalar (yağlar,keçeler,contalar,rulmanlar,segmanlar,kanatlar,çekiçler,soketler v.s.),
- * Amaca uygun olmayan kullanım, aşırı zorlama, eksik bakım veya koruma amaçlı aksesuar ve diğer kısımlarda meydana gelen arızalar (muhafazalar, pensler,mandrenler,hortumlar,rakorlar,nipeller v.s.),
- * Anormal çevre şartları ve uygunsuz işletme şartlarında kullanım, ürünün içine toz toprak, çapak, sıvı girmesine karşın temizliğinin yapılmadan kullanılmasıyla oluşan arızalar,
- * Orijinal olmayan veya yıpranmış, körelmiş, aksesuarların kullanımı sonucu oluşan hasar ve arızalar,
- * Uygun olmayan yağ, yağsız kullanım ve basınçlı hava kullanımına bağlı arızalar,
- * Gerekli bakımlarının yapılmamasından kaynaklanan arızalar,
- * Hatalı ürün seçiminden kaynaklanan arızalar (Profesyonel ürün yerine hafif işlerde kullanım için üretilmiş ürün seçilmesi v.s.),
- * Ürünün tesliminden sonra nakliye, boşaltma, yükleme, harici fiziki (kırık,çatlak,çizik,ezilme vb) ve kimyevi etkenlerden meydana gelen arıza ve hasarlar,
- * Yangın, yıldırım düşmesi, donma ve doğal afetlerden kaynaklanan arızalar,
- * Savaş, terör, gösteri ve eylemler sonucu oluşan arıza ve hasarlar,

GARANTİ KAPSAMINA GİRMEMEKTEDİR.

BAKIM ONARIM ŞARTLARI

- * Tamir için verilen fiyat teklifleri 2 ay geçerlidir.
- * Tamirin tamamlandığı ve onarım ücreti müşteriye bildirildikten sonra o ay içinde alınmayan ürünler için teslim ayındaki döviz kuru ile çarpılan yeni fiyatlar uygulanır.
- * Yetkili servislerimizde ücretli değiştirilen parçalar 6 (altı) ay garantilidir.
- * Onarım sırasında ücretli değiştirilen parçalar, müşteriye onarım bitiminde teslim edilmekte olup teslim alınmayan arızalı parçalar firmamız tarafından imha edilir.Müşteri teslim almadığı arızalı parçalar için hak iddia edemez.



Not:

