



# SH

## AIR TOOLS



## 1/2" KABZALI MİNİ SOMUN SIKMA-SÖKME



Soket	1/2"
Max.Torku	55kg/m
Ağırlığı	1,60 Kg
Devir	8500d/dk
Çekiç Sistemi	Tekli gözlük çekiç
Hava Girişi	1/4"

SH-7277

\$53,00

## 1/2" KABZALI SOMUN SIKMA-SÖKME



Soket	1/2"
Max.Torku	150kg/m
Ağırlığı	2,00 Kg
Devir	8000d/dk
Çekiç Sistemi	İkiz gözlük çekiç
Hava Girişi	1/4"

Composit  
Gövde  
Düşük ses

SH-7304

\$58,00

## 3/4" KABZALI SOMUN SIKMA-SÖKME



Soket	3/4"
Max.Torku	200kg/m
Ağırlığı	8,00 Kg
Devir	4300d/dk
Çekiç Sistemi	İkiz gözlük çekiç
Hava Girişi	1/2"

SH-7310

\$118,00

## 1" KABZALI SOMUN SIKMA-SÖKME



Soket	1"
Max.Torku	240kg/m
Ağırlığı	9,98 Kg
Devir	5000d/dk
Çekiç Sistemi	Pimli çeliç
Hava Girişi	1/2"

SH-7880

\$157,00



# AIR TOOLS

## AIR ACCESSORIES

Most Complete, Competent and Knowledgeable Supplier for You

[www.steedtools.com](http://www.steedtools.com)

**NINGBO STEED TOOLS CO., LTD.**

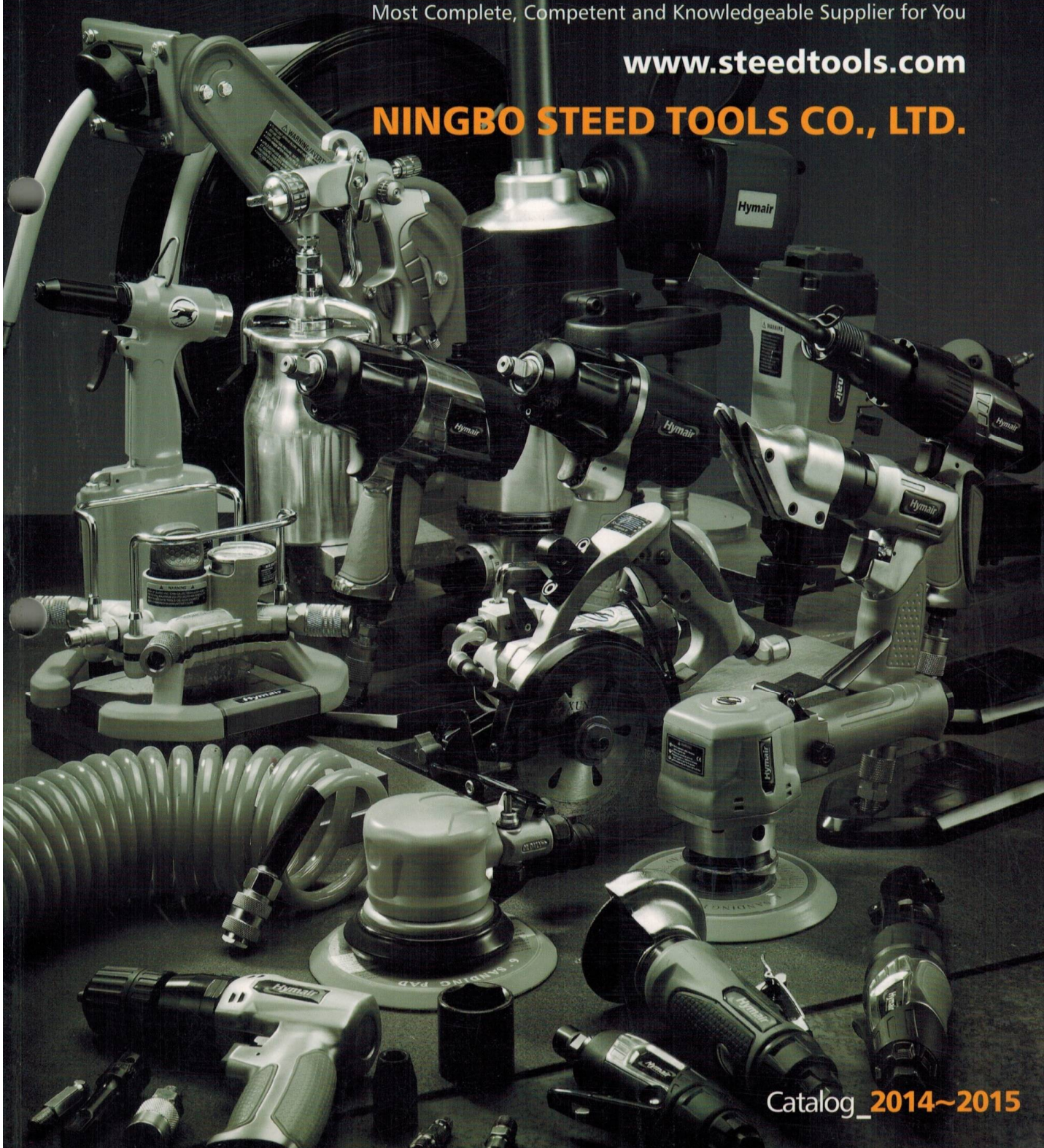

Catalog\_2014~2015

## 3/8" KELEBEK SOMUN SIKMA-SÖKME



Soket	3/8"
Max.Torku	10kg/m
Ağırlığı	0,90 Kg
Uzunluğu	160x85mm
Devir	10000d/dk
Çekiç Sistemi	Tek çekiç
Hava Girişi	1/4"



**AT-5030**

**\$36,20**

## 3/8" KABZALI SOMUN SIKMA-SÖKME



Soket	3/8"
Max.Torku	18kg/m
Ağırlığı	1,19 Kg
Uzunluğu	172x136mm
Devir	9000d/dk
Çekiç Sistemi	Tek çekiç
Hava Girişi	1/4"



**AT-5031**

**\$36,20**

## 3/8" KABZALI SOMUN SIKMA-SÖKME



Soket	3/8"
Max.Torku	34kg/m
Ağırlığı	1,50 Kg
Uzunluğu	180x160mm
Devir	8000d/dk
Çekiç Sistemi	İkiz gözlük çekiç
Hava Girişi	1/4"



**PAT-103**

**\$59,90**

## 1/2" KABZALI MİNİ SOMUN SIKMA-SÖKME



**MINI**

**Hafif-Küçük  
Güçlü Model**

Soket	1/2"
Max.Torku	68kg/m
Ağırlığı	1,61 Kg
Uzunluğu	180x130mm
Devir	10000d/dk
Çekiç Sistemi	İkiz gözlük çekiç
Hava Girişi	1/4"



**NST-500M**

**\$90,40**

## 1/2" KABZALI SOMUN SIKMA-SÖKME



Soket	1/2"
Max.Torku	34kg/m
Ağırlığı	2,18 Kg
Uzunluğu	205x200mm
Devir	7000d/dk
Çekiç Sistemi	Tek çekiç
Hava Girişi	1/4"



**AT-5040**

**\$38,50**

SET	m9,10,11,13,14 17,19,22,24,27 Lokmalar +Uzatma
-----	--

**AT-5004**

**\$49,80**

# HYMAIR

## 1/2" KABZALI SOMUN SIKMA-SÖKME



Soket	1/2"
Max.Torku	68kg/m
Ağırlığı	2,79 Kg
Uzunluğu	195x193mm
Devir	7000d/dk
Çekiç Sistemi	İkiz gözlük çekiç
Hava Girişi	1/4"



AT-239

\$66,70

SET	m10,11,13,14,17 19,22,24 Lokmalar +Uzatma
-----	---

AT-239K

\$84,80

## 1/2" KABZALI SOMUN SIKMA-SÖKME



Ağır Hizmet  
Tipi

Soket	1/2"
Max.Torku	115kg/m
Ağırlığı	2,55 Kg
Uzunluğu	205x205mm
Devir	6800d/dk
Çekiç Sistemi	İkiz gözlük çekiç
Hava Girişi	1/4"



AT-T1252C

\$128,90

## 3/4" KABZALI SOMUN SIKMA-SÖKME



Soket	3/4"
Max.Torku	68kg/m
Ağırlığı	4,45 Kg
Uzunluğu	247x240mm
Devir	4500d/dk
Çekiç Sistemi	Tek çekiç
Hava Girişi	1/4"

AT-261

\$90,40

## 3/4" KABZALI SOMUN SIKMA-SÖKME



Soket	3/4"
Max.Torku	130kg/m
Ağırlığı	2,60 Kg
Uzunluğu	242x235mm
Devir	5000d/dk
Çekiç Sistemi	İkiz gözlük çekiç
Hava Girişi	3/8"

AT-272

\$197,80

## 3/4" KABZALI SOMUN SIKMA-SÖKME



Ağır Hizmet  
Tipi



Soket	3/4"
Max.Torku	160kg/m
Ağırlığı	6,80 Kg
Uzunluğu	266x242mm
Devir	4200d/dk
Çekiç Sistemi	İkiz gözlük çekiç
Hava Girişi	3/8"

AT-265

\$206,80

## 1" KABZALI SOMUN SIKMA-SÖKME



Ağır Hizmet  
Tipi



Soket	1"
Max.Torku	160kg/m
Ağırlığı	6,80 Kg
Uzunluğu	266x242mm
Devir	4200d/dk
Çekiç Sistemi	İkiz gözlük çekiç
Hava Girişi	3/8"

AT-266

\$243,00

## 1" DÜZ TİP SOMUN SIKMA-SÖKME



Soket	1"-Uzun
Max.Torku	320kg/m
Ağırlığı	16,50 Kg
Uzunluğu	582x185mm
Devir	3200d/dk
Çekiç Sistemi	Pimli çekiç
Hava Girişi	1/2"

AT-9981

\$444,10

## 1" DÜZ TİP SOMUN SIKMA-SÖKME



Soket	1"-Kısa
Max.Torku	220kg/m
Ağırlığı	12,70 Kg
Uzunluğu	350x185mm
Devir	3900d/dk
Çekiç Sistemi	Pimli çekiç
Hava Girişi	1/2"

AT-4500A

\$327,70

## 1" DÜZ TİP SOMUN SIKMA-SÖKME



Soket	1"-Uzun
Max.Torku	220kg/m
Ağırlığı	13,40 Kg
Uzunluğu	550x185mm
Devir	3900d/dk
Çekiç Sistemi	Pimli çekiç
Hava Girişi	1/2"

AT-4500

\$327,70

## 1" DÜZ TİP SOMUN SIKMA-SÖKME



Soket	1"-Uzun
Max.Torku	380kg/m
Ağırlığı	19,00 Kg
Uzunluğu	659x180mm
Devir	3300d/dk
Çekiç Sistemi	Pimli çekiç
Hava Girişi	1/2"

AT-4600

\$339,00

## 1" DÜZ TİP SOMUN SIKMA-SÖKME

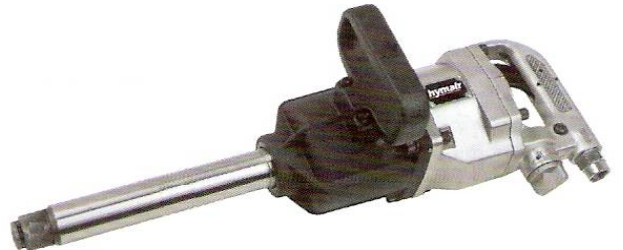

Soket	1"-Uzun
Max.Torku	280kg/m
Ağırlığı	12,00 Kg
Uzunluğu	510x180mm
Devir	3200d/dk
Çekiç Sistemi	İkiz gözlük çekiç
Hava Girişi	1/2"

AT-8200

\$469,00

## 1" DÜZ TİP SOMUN SIKMA-SÖKME



Soket	1"-Kısa
Max.Torku	190kg/m
Ağırlığı	10,53 Kg
Uzunluğu	350mm
Devir	3500d/dk
Çekiç Sistemi	Pimli çekiç
Hava Girişi	1/2"



AT-285-7

\$293,80

Soket	1"-Uzun
Max.Torku	190kg/m
Ağırlığı	12,60 Kg
Uzunluğu	510mm
Devir	3500d/dk
Çekiç Sistemi	Pimli çekiç
Hava Girişi	1/2"

AT-285-6

\$293,80

## 1/4" CIRCIR



Soket	1/4"
Max.Torku	2,7kg/m
Ağırlığı	0,51 Kg
Uzunluğu	170x53mm
Devir	230d/dk
Hava Girişi	1/4"

AT-5055N

\$36,20

## 3/8"-1/2" CIRCIR



Soket	3/8"
Max.Torku	7kg/m
Ağırlığı	1,13 Kg
Uzunluğu	263x53mm
Devir	160d/dk
Hava Girişi	1/4"

AT-5057

\$33,90

Soket	1/2"
Max.Torku	7kg/m
Ağırlığı	1,13 Kg
Uzunluğu	263x53mm
Devir	160d/dk
Hava Girişi	1/4"

AT-5056

\$33,90

## 1/2" CIRCIR



Soket	1/2"
Max.Torku	8,5kg/m
Ağırlığı	1,22 Kg
Uzunluğu	275x57mm
Devir	160d/dk
Hava Girişi	1/4"

AT-5059A

\$61,10

## KALIPÇI TAŞLAMA



Pens Ölçüsü	6mm
Ağırlığı	0,38 Kg
Uzunluğu	148x60mm
Devir	25000d/dk
Egzost	Arkadan
Hava Girişi	1/4"

**AT-7032**

**\$17,00**

Pens Ölçüsü	6mm
Ağırlığı	0,60 Kg
Uzunluğu	168x68mm
Devir	22000d/dk
Egzost	Arkadan
Hava Girişi	1/4"

**AT-7033**

**\$17,00**

SET	10 adet muhtelif Saplı taş 3-6mm Pens Rakor
-----	--

**AT-7033K**

**\$22,60**

## KALIPÇI TAŞLAMA



Pens Ölçüsü	6mm
Ağırlığı	0,38 Kg
Uzunluğu	148x60mm
Devir	25000d/dk
Egzost	Arkadan
Hava Girişi	1/4"

**AT-7032B**

**\$19,30**

Pens Ölçüsü	6mm
Ağırlığı	0,60 Kg
Uzunluğu	168x68mm
Devir	22000d/dk
Egzost	Arkadan
Hava Girişi	1/4"

**AT-7033B**

**\$19,30**

SET	10 adet muhtelif Saplı taş 3-6mm Pens Rakor
-----	--

**AT-7033BK**

**\$29,40**

## MİKRO KALIPÇI TAŞLAMA



16 parçalı set	
Pens Ölçüsü	3mm
Devir	35000d/dk
Egzost	Arkadan
Hava Girişi	1/4"

**AT-3000K**

**\$52,00**

## KALIPÇI TAŞLAMA VE KESME SETİ



Pens Ölçüsü	3mm
Ağırlığı	0,20 Kg
Uzunluğu	134x16mm
Devir	54000d/dk
Egzost	Arkadan
Hava Girişi	1/4"

**AT-3170**

**\$29,40**

SET	10 adet muhtelif Saplı taş Mini yağlayıcı Rakor
-----	--

**AT-010K**

**\$33,90**

## KALIPÇI TAŞLAMA VE KESME SETİ



22 parçalı set	
Pens Ölçüsü	6mm
Taş Çapı	76mm
Ağırlığı	0,78 Kg
Uzunluğu	185x80mm
Devir	22000d/dk
Egzost	Arkadan
Hava Girişi	1/4"

**AT-012BK**

**\$52,00**

## 90° KALIPÇI TAŞLAMA



Pens Ölçüsü	6mm
Ağırlığı	0,53 Kg
Uzunluğu	154x78mm
Devir	20000d/dk
Egzost	Arkadan
Hava Girişi	1/4"

**AT-7034**

**\$33,90**

## UZUN TİP KALIPÇI TAŞLAMA



Pens Ölçüsü	6mm
Ağırlığı	1,31 Kg
Uzunluğu	338x70mm
Devir	22000d/dk
Egzost	Arkadan
Hava Girişi	1/4"

**AT-7033LB**

**\$37,30**

## METALE YAZI YAZMA



Vuruş Adedi	13000bpm
Ağırlığı	0,39 Kg
Uzunluğu	173x68mm
Hava Girişi	1/4"

**AT-3190P**

**\$67,80**

## LASTİK TAŞLAMA



Uç Tipi	Şişşaklı
Ağırlığı	0,97 Kg
Uzunluğu	212x68mm
Devir	2500d/dk
Egzost	Arkadan
Hava Girişi	1/4"

**AT-7070B**

**\$45,20**

## LASTİK TAŞLAMA



Uç Tipi	Şişşaklı
Ağırlığı	0,97 Kg
Uzunluğu	212x68mm
Devir	2500d/dk
Egzost	Arkadan
Hava Girişi	1/4"

**AT-7070C**

**\$50,90**

# HYMAIR

## DÜZ TİP SHUT-OFF'LU TORNAVİDA



Uç Ölçüsü	1/4"
Kapasitesi	4mm
Ağırlığı	0,68 Kg
Uzunluğu	238x50mm
Devir	1000d/dk
Hava Girişi	1/4"

AT-4055

\$96,10

## DÜZ TİP TORNAVİDA



Uç Ölçüsü	1/4"
Kapasitesi	4mm
Ağırlığı	0,67 Kg
Uzunluğu	203x50mm
Devir	1500d/dk
Hava Girişi	1/4"

AT-4050

\$44,10

## DÜZ TİP DARBELİ TORNAVİDA



Uç Ölçüsü	1/4"
Kapasitesi	5mm
Ağırlığı	0,70 Kg
Uzunluğu	195x60mm
Devir	12000d/dk
Hava Girişi	1/4"

AT-W5

\$44,10

## MİKRO TİP 4mm MATKAP



17 parçalı set	
Mandren	4mm
Devir	35000d/dk
Egzost	Arkadan
Hava Girişi	1/4"

AT-3100K

\$56,50

## 10mm DÜZ TİP MATKAP



Mandren	10mm
Dönüş	Sağ
Ağırlığı	0,90 Kg
Uzunluğu	210x68mm
Devir	2500d/dk
Hava Girişi	1/4"

AT-4038

\$30,60

## 10mm KABZALI MATKAP



Mandren	10mm
Dönüş	Sağ-Sol
Ağırlığı	1,11 Kg
Uzunluğu	183x142mm
Devir	1800d/dk
Hava Girişi	1/4"

**AT-4031**

**\$45,20**

## 10mm KABZALI MATKAP



Mandren	10mm
Dönüş	Sağ-Sol
Ağırlığı	1,48 Kg
Uzunluğu	185x155mm
Devir	2200d/dk
Hava Girişi	1/4"

Ağır Hizmet  
Elle Sıkmalı  
Plastik  
Mandren

**PAT-401KL**

**\$50,90**

## 13mm KABZALI MATKAP



Mandren	13mm
Dönüş	Sağ-Sol
Ağırlığı	1,62 Kg
Uzunluğu	223x150mm
Devir	700d/dk
Hava Girişi	1/4"

**AT-4041B**

**\$49,80**

## YÜZEY TEMİZLEME



Disk çapı	87mm
Ağırlığı	0,97 Kg
Uzunluğu	226x93mm
Devir	4000d/dk
Egzost	Arkadan
Hava Girişi	1/4"

**Yedek Diski**

**\$11,30**

**AT-7036B**

**\$54,30**

## 100mm SATIŞ TAŞLAMA



Taş Çapı	100mm
Diş Ölçüsü	3/8x24UNF
Ağırlığı	1,38 Kg
Uzunluğu	185x120mm
Devir	11000d/dk
Hava Girişi	1/4"

**AT-282**

**\$67,80**

## 125mm SATIŞ TAŞLAMA



Taş Çapı	125mm
Diş Ölçüsü	3/8x24UNF
Ağırlığı	1,75 Kg
Uzunluğu	223x140mm
Devir	11000d/dk
Hava Girişi	1/4"

Ağır Hizmet

**AT-285B**

**\$101,70**

# HYMAIR

## 180mm SATIH TAŞLAMA



Taş Çapı	180mm
Diş Ölçüsü	5/8x11B5W
Ağırlığı	3,06 Kg
Uzunluğu	310x240mm
Devir	8400d/dk
Hava Girişi	1/4"

Ağır Hizmet

AT-782

\$167,30

## 150mm YATAY TİP SATIH TAŞLAMA



Taş Çapı	150mm
Ağırlığı	5,00 Kg
Uzunluğu	485mm
Devir	6600d/dk
Hortum Girişi	16mm

Ağır Hizmet  
Yatay Tip

AT-150Z66A

\$327,70

## DAİRESEL ZIMPARA



Disk Çapı	180mm
Ağırlığı	1,90 Kg
Uzunluğu	370x171mm
Devir	4500d/dk
Hava Girişi	1/4"

AT-880A

\$99,50

## EKSANTRİK DAİRESEL ZIMPARA



Disk Çapı	150mm
Eksantrik	5mm
Ağırlığı	1,06 Kg
Uzunluğu	175x143mm
Devir	9000d/dk
Hava Girişi	1/4"

AT-980

\$61,10

Disk Çapı	150mm
Eksantrik	5mm
Ağırlığı	1,06 Kg
Uzunluğu	175x143mm
Devir	9000d/dk
Hava Girişi	1/4"

Toz Emişli

AT-980V

\$72,40

# HYMAIR

## EKSANTRİK DAİRESEL ZIMPARA



Disk Çapı	150mm
Eksantrik	5mm
Ağırlığı	1,74 Kg
Uzunluğu	255x143mm
Devir	10000d/dk
Hava Girişi	1/4"

AT-280

\$45,20

## SULU TİP DAİRESEL ZIMPARA



Disk çapı	125mm
Ağırlığı	3,90 Kg
Uzunluğu	277x102mm
Devir	6000d/dk
Hava Girişi	1/4"

Sulu Tip

AT-185WL

\$149,00

SET	19 Parçalı
-----	------------

AT-185WL-K

\$271,20

## SULU TİP DAİRESEL ZIMPARA



Disk çapı	125mm
Ağırlığı	3,96 Kg
Uzunluğu	257x102mm
Devir	5500d/dk
Hava Girişi	1/4"

Sulu Tip

AT-185WH

\$125,00

SET	17 Parçalı
-----	------------

AT-185WH-K

\$196,70

## EKSANTRİK TİTREŞİMLİ ZIMPARA

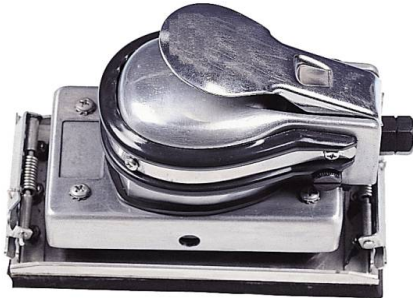

Taban Ölçüsü	95x175mm
Eksantrik	5mm
Ağırlığı	1,89 Kg
Uzunluğu	187x125mm
Devir	8000d/dk
Hava Girişi	1/4"

AT-7018

\$45,20

## RENDE ZIMPARA

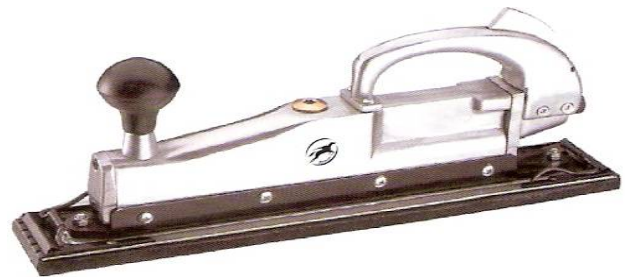

Taban Ölçüsü	64x407mm
Strok	25mm
Ağırlığı	2,56 Kg
Uzunluğu	400x170mm
Devir	2500d/dk
Hava Girişi	1/4"

AT-186

\$61,10

## SULU TİP ZIMPARA POLİSAJ



Disk çapı	180mm
Diş ölçüsü	5/8x11UNC
Ağırlığı	4,34 Kg
Uzunluğu	365x113mm
Devir	4500d/dk
Hava Girişi	1/4"

Sulu Tip

**AT-880AW-R**

**\$249,00**

## BANT ZIMPARA



Bant Ölçüsü	10x330mm
Ağırlığı	0,78 Kg
Uzunluğu	280x75mm
Devir	16000d/dk
Hava Girişi	1/4"

**AT-480**

**\$72,40**

## SULU TİP TAŞ, MERMER ve KARO KESME



Disk çapı	100mm
Kapasitesi	30mm
Kesme açısı	45 dereceye kadar
Ağırlığı	2,92 Kg
Uzunluğu	330mm
Devir	7000d/dk
Hava Girişi	1/4"

Sulu Tip

**AT-600W**

**\$145,80**

## AĞIR HİZMET POP PERÇİN PENSESİ



Kapasitesi	6mm
Çekme Gücü	850kgs
Strok	14mm
Ağırlığı	1,66 Kg
Uzunluğu	225x93mm
Hava Girişi	1/4"

**AT-6017**

**\$107,40**

## DÖKÜMCÜ TOKMAKLARI (KUM SIKIŞTIRMA)



Mil Çapı-Strok	25mm-100mm
Ağırlığı	6,00 Kg
Uzunluğu	950-1095mm
Vuruş Adedi	900bpm
Hortum Girişi	1/2"

**AT-D6**

**\$266,70**

Mil Çapı-Strok	32mm-120mm
Ağırlığı	9,50 Kg
Uzunluğu	1140-1380mm
Vuruş Adedi	900bpm
Hortum Girişi	1/2"

**AT-D9**

**\$322,10**

## TESTERE



Kesme kap./Çelik	1,6mm
/Alüminyum	2mm
Strok Hareketi	10000s/dk
Ağırlığı	0,64 Kg
Uzunluğu	235x70mm
Hava Girişi	1/4"

AT-7039

\$47,50

## EĞELEME ve TESTERE



Piston Stroku	5mm
Strok Hareketi	3400s/dk
Ağırlığı	0,50 Kg
Uzunluğu	163x62mm
Hava Girişi	1/4"

Arkadan  
Egzost

AT-6070

\$152,60

## CAM FİTİLİ (SİLİKONU) KESME

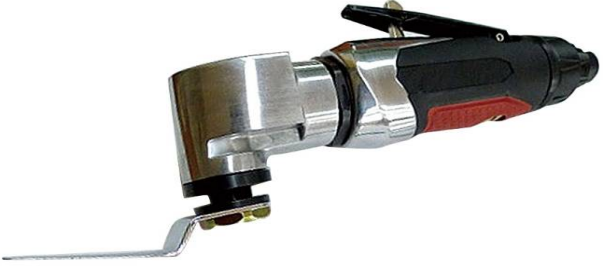

Devir/Strok	20000d/dk/75mm
Ağırlığı	0,89 Kg
Uzunluğu	257mm
Hava Girişi	1/4"

AT-9039

\$49,80

## İĞNE UÇLU KABZALI KESKİ



İğne Çapı / Ad.	3mm/23 adet
Vuruş Adedi	4500bpm
Ağırlığı	2,70 Kg
Uzunluğu	360mm
Hava Girişi	1/4"

AT-XC23

\$186,50

## ÇEKİÇ-KESKİ



Piston Çapı	19mm
Piston Stroku	41mm
Vuruş Adedi	4500bpm
Ağırlığı	1,13 Kg
Uzunluğu	170x145mm
Hava Girişi	1/4"

4 adet  
ucuyla

AT-  
2010R-K

\$39,60

Piston Çapı	19mm
Piston Stroku	66mm
Vuruş Adedi	3000bpm
Ağırlığı	1,45 Kg
Uzunluğu	220x145mm
Hava Girişi	1/4"

4 adet  
ucuyla

AT-  
2020RSG-K

\$50,90

## İĞNE UÇLU KABZALI KESKİ



İğne Çapı / Ad.	3mm/19 adet
Piston Stroku	24mm
Vuruş Adedi	4500bpm
Ağırlığı	1,95 Kg
Uzunluğu	342x145mm
Hava Girişi	1/4"

AT-8039D

\$84,80

# HYMAIR

## İĞNE UÇLU DÜZ KESKİ



İğne Çapı / Ad.	3mm/12 adet
Piston Stroku	24mm
Vuruş Adedi	2800bpm
Ağırlığı	1,10 Kg
Uzunluğu	215x80mm
Hava Girişi	1/4"

AT-8039

\$55,40

## İĞNE UÇLU DÜZ KESKİ



İğne Çapı / Ad.	3mm/19 adet
Piston Stroku	40mm
Vuruş Adedi	4600bpm
Ağırlığı	2,79 Kg
Uzunluğu	465x77mm
Hava Girişi	1/4"

AT-8039P

\$149,20

## LASTİK TAMİR (DÖVME) ALETİ



Piston Stroku	66mm
Vuruş Adedi	3000bpm
Ağırlığı	1,45 Kg
Uzunluğu	220x145mm
Hava Girişi	1/4"

AT-7036ESG

\$62,20

## BETON KIRICI



Silindir Çapı	38mm
Ağırlığı	10,00 Kg
Uzunluğu	570mm
Hava Girişi	13mm

AT-G10

\$194,40

## MAZOT TABANCASI



WG-02

\$33,90

## MOTOR YIKAMA



J109

\$13,60

## BOYA TABANCASI



Meme Ölçüsü	1,8mm
Depo	Alttan-Metal
2 kademeli tetik, Hafif Alüminyum	
Ayarlanabilir püskürtme genişliği	
Ayarlı akışkan çıkışı ve hava girişi	
Kaymayı önleyici kontrol düğmesi	

AS-4001

\$42,00

# HYMAIR

## BOYA KARIŐTIRMA

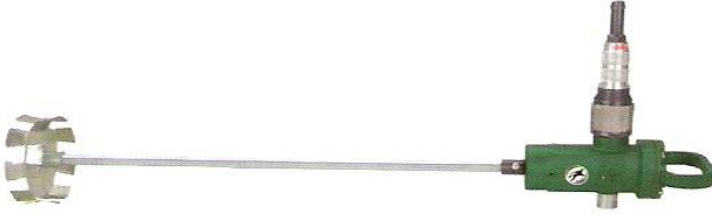

Kafa apı	100mm
Ađırlıđı	3,00 Kg
Uzunluđu	600mm
Devir	2000d/dk
Hortum GiriŐi	13mm

AT-TJ3

\$311,90

## ŐARTLANDIRICI (HAVA HAZIRLAYICI)



4000-04D

1/2"

\$50,90

5000-10D

1"

\$135,60

## GRES TABANCASI



Kapasitesi	500cc
Ađırlıđı	1,32 Kg
Uzunluđu	395x370mm
Hava GiriŐi	1/4"

AT-6036

\$24,90

SET El pompa aparatı ile birlikte

AT-6036-6

\$33,40

## TEMİZLİK SETİ



7 para,Mini sprge,Hava tab. Basıncılı su tabancası,Lastik ŐiŐirme, Spiral hortum,Fıra ve Eldiven

AK-10

\$50,90

## SİLİKON TABANCASI



Ađırlıđı	0,92 Kg
Uzunluđu	290x168mm
Hava GiriŐi	1/4"

AT-193

\$24,90

## KAPORTACI SETİ



7 para  
eki  
Dayama

HD-100

\$101,70

## İBRE GÖSTERGELİ LASTİK ŐİŐİRME



TG-31L

\$47,50



TG-02

\$17,00



# ENDO



# ENDO

## ERP SERİSİ YAYLI BALANSER



Kapasite 0,30-0,60 Kg  
Halat Boyu 1,50mt

ERP-06E

€ 148,00

Kapasite 0,50-1,00 Kg  
Halat Boyu 1,50mt

ERP-1E

€ 152,00

Kapasite 1,00-2,00 Kg  
Halat Boyu 1,30mt

ERP-2E

€ 169,00

## EK-EW SERİSİ YAYLI BALANSER



Kapasite 0,50-1,50 Kg  
Halat Boyu 0,50mt

EK-00

€ 110,00

Kapasite 0,50-1,50 Kg  
Halat Boyu 1,00mt

EK-0

€ 178,00

Kapasite 1,00-3,00 Kg  
Halat Boyu 1,30mt

EW-3

€ 287,00

## EWS SERİSİ YAYLI BALANSER



Kapasite 1,50-3,00 Kg  
Halat Boyu 1,30mt

EWS-3

€ 322,00

Kapasite 3,00-5,00 Kg  
Halat Boyu 1,30mt

EWS-5

€ 351,00

Kapasite 5,00-7,00 Kg  
Halat Boyu 1,30mt

EWS-7

€ 411,00

# ENDO

## EFW SERİSİ YAYLI BALANSER



Kapasite 4,50-9,00 Kg  
Halat Boyu 1,30mt

**EFW-9**

**€ 603,00**

Kapasite 9,00-15,00 Kg  
Halat Boyu 1,30mt

**EFW-15**

**€ 645,00**

Kapasite 15,00-22,00 Kg  
Halat Boyu 1,50mt

**EFW-22**

**€ 973,00**

Kapasite 22,00-30,00 Kg  
Halat Boyu 1,50mt

**EFW-30**

**€ 1.025,00**

Kapasite 30,00-40,00 Kg  
Halat Boyu 1,50mt

**EFW-40**

**€ 1.374,00**

Kapasite 40,00-50,00 Kg  
Halat Boyu 1,50mt

**EFW-50**

**€ 1.434,00**

Kapasite 50,00-60,00 Kg  
Halat Boyu 1,50mt

**EFW-60**

**€ 1.580,00**

Kapasite 60,00-70,00 Kg  
Halat Boyu 1,50mt

**EFW-70**

**€ 1.661,00**

Kapasite 70,00-90,00 Kg  
Halat Boyu 2,00mt

**EFW-90**

**€ 2.718,00**

Kapasite 85,00-105,00 Kg  
Halat Boyu 2,00mt

**EFW-105**

**€ 2.943,00**

Kapasite 100,00-120,00 Kg  
Halat Boyu 2,00mt

**EFW-120**

**€ 3.189,00**

## ETP SERİSİ YAYLI BALANSER



Kapasite 120,00-140,00 Kg  
Halat Boyu 1,20mt

**ETP-14**

**€ 4.227,00**

Kapasite 140,00-170,00 Kg  
Halat Boyu 1,20mt

**ETP-15**

**€ 4.910,00**

Kapasite 170,00-200,00 Kg  
Halat Boyu 1,20mt

**ETP-16**

**€ 5.206,00**



## KALIPÇI TAŞLAMA



Devir	65000d/dk
Pens Ölçüsü	3mm
Tipi	Kalem tip
Ölçüleri	161x16,7mm
Ağırlığı	130gr

**MSG-3BSN**

**\$470,00**

## KALIPÇI TAŞLAMA



Devir	65000d/dk
Pens Ölçüsü	3mm
Tipi	Kalem tip
Ölçüleri	165x22mm
Ağırlığı	78gr

**FX3.0**

**\$423,00**

## KALIPÇI TAŞLAMA



Devir	23500d/dk
Tipi	Kalem tip 45 derece
Ölçüleri	142x48x32mm
Ağırlığı	175gr

**MAG-123.N**

**\$500,00**

## KALIPÇI TAŞLAMA



Devir	23500d/dk
Tipi	Kalem tip 90 derece
Ölçüleri	138x41x33mm
Ağırlığı	160gr

**MAG-093.N**

**\$500,00**

## SAĞ-SOL HAREKETLİ EĞELEME



Devir	56000d/dk
Strok	0,3mm
Ölçüleri	218x28mm
Ağırlığı	180gr

**TLS-03**

**\$625,00**

Devir	20000d/dk
Strok	0,7mm
Ölçüleri	218x28mm
Ağırlığı	180gr

**TLS-07**

**\$625,00**

Devir	14000d/dk
Strok	1,2mm
Ölçüleri	218x28mm
Ağırlığı	180gr

**TLS-12**

**\$625,00**

## İLERİ-GERİ HAREKETLİ EĞELEME



Devir	52000d/dk
Strok	0,3mm
Ölçüleri	218x28mm
Ağırlığı	180gr

**TLL-03**

**\$625,00**

Devir	28000d/dk
Strok	0,7mm
Ölçüleri	218x28mm
Ağırlığı	180gr

**TLL-07**

**\$625,00**

Devir	19000d/dk
Strok	1,2mm
Ölçüleri	218x28mm
Ağırlığı	180gr

**TLL-12**

**\$625,00**

## KALIPÇI TAŞLAMA



Devir	52500d/dk
Tipi	Kalem tip 120 derece
Ölçüleri	142x55x17mm
Ağırlığı	140gr

**MAG-121.N**

**\$517,00**



## İBRE GÖSTERGELİ LASTİK ŞİŞİRME



Max.Giriş Basıncı	13,8bar / 200psi
Şişirme Basıncı	0-9,6bar 0-138psi
Okuma Aralığı	0,1bar / 2psi
Hortum Boyu	0,53m

**AIRFORCE MK4  
AFG4H03**

**€ 91,00**

Max.Giriş Basıncı	27bar / 392psi
Şişirme Basıncı	3-21bar 45-300psi
Okuma Aralığı	0,25bar / 5psi
Hortum Boyu	1,80m

**AIRFORCE MK4  
AFG6H041**

**€ 182,00**

## İBRE GÖSTERGELİ LASTİK ŞİŞİRME



Max.Giriş Basıncı	15bar / 218psi
Şişirme Basıncı	0-12bar 0-170psi
Okuma Aralığı	0,1bar / 2psi
Hortum Boyu	1,80m

**AIRFORCE  
AFG1H08**

**€ 91,00**

## DİJİTAL GÖSTERGELİ LASTİK ŞİŞİRME



Max.Giriş Basıncı	16bar / 232psi
Şişirme Basıncı	0-12bar 0-174psi
Okuma Aralığı	0,1bar / 2psi
Hortum Boyu	1,80m

**ACCURA 1  
DTI08**

**€ 121,00**

## DİJİTAL GÖSTERGELİ LASTİK ŞİŞİRME



Max.Giriş Basıncı	17,2bar / 250psi
Şişirme Basıncı	0,3-17bar 4-250psi
Okuma Aralığı	0,1bar / 2psi
Hortum Boyu	0,53m

**ACCURA MK4  
DAC403**

**€ 103,00**

## DİJİTAL LASTİK DİŞ KUMPASI



Dijital, lastik diş derinlik ölçüm kumpası

**DTD61D04**

**€ 18,50**



Dijital, lastik diş derinlik ölçüm kumpası+Lastik basınç ölçme

**DTP67**

**€ 19,50**



# TORNADOR

INNOVATED AIR/WATER CLEANING TOOL

- QUICK & EASY TO USE
- IDEAL FOR HARD TO CLEAN AREAS
- CLEANS CRACKS & CREVICES LIKE NEVER BEFORE
- CLEANS & AIR DRIES IN SECONDS
- ENERGIZES PRODUCT FOR QUICK ACTION CLEANING
- JUST AIR & TURBO CLEANER PRODUCT NEEDED
- SAVES TIME & MONEY
- RUGGED CONSTRUCTION
- EASY TO MAINTAIN



QUICKLY CLEANS AND AIR DRIES...



CARPETS & UPHOLSTERY...



VENTS...



HARD TO REACH AREAS...



CRACKS AND CREVICES

# TORNADOR

## OTO TEMİZLİK TABANCASI



Hava ile çalışan bu temizlik tabancası zamandan %70 sarfiyattan ise %90'a varan tasarruf sağlamaktadır. Yapısı itibarıyla otomobilin tavan,taban,kapı,yer döşemesi,plastik,vinil ve motor parçalarını çok kısa sürede temizlemenizi sağlar.

**TORNADOR**  
**Classic Z-010**  
**\$220,00**



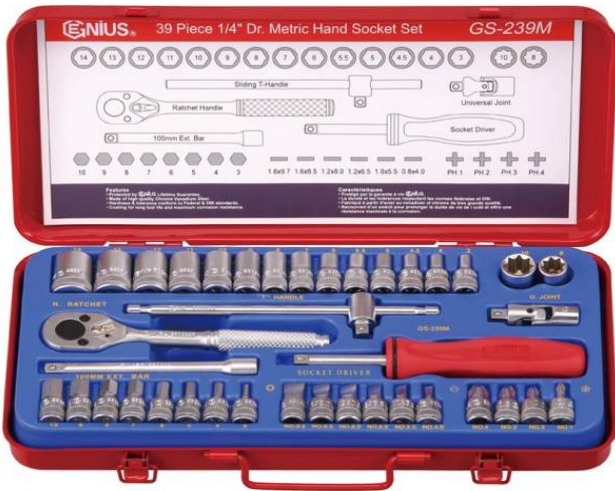

## HAVALI LOKMA TAKIMI

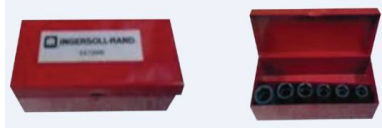

1/2"	KISA	GS-409M
9 p.	ALTIKÖŞE: 11-22mm	\$38,80

Kısa Lokma: m11-12-13-14-16-17-19-21-22

3/4"	KISA	CM-021
8 p.	ALTIKÖŞE: 1"-1.1/2"	\$128,80

Kısa Lokma: 1"-1,1/16-1,1/8-1,1/4-1,5/16-1,3/8-1,7/16-1,1/2

1"	KISA	CM-029
9 p.	ALTIKÖŞE: 1"-2"	\$239,30

Kısa Lokma: 1-1,1/8-1,1/4-1,3/8-1,1/2-1,5/8-1,3/4-1,7/8-2



3/8"	KISA	SS-72MB
6 p.	ALTIKÖŞE: 8-13mm	\$26,80

Kısa Lokma: m8-9-10-11-12-13

3/4"	KISA	CM-022 CM-608M
8 p.	ALTIKÖŞE: 26-38mm	\$107,60

Kısa Lokma: m26-27-29-30-32-35-36-38

1"	KISA	CM-110 CM-809M
9 p.	ALTIKÖŞE: 24-50mm	\$190,70

Kısa Lokma: m24-27-30-32-35-38-41-46-50

## HAVALI LOKMA TAKIMI



3/4"	UZUN	CM-608M4 CD-608M4
8 p.	ALTIKÖŞE: 27-41mm KARE: 19-21mm	\$190,70

Uzun Lokma: m27-30-32-35-38-41

Uzun Kare lokma: m19-21

3/8"	UZUN	TD-308M
8 p.	ALTIKÖŞE: 8-19mm	\$59,00

Kısa Lokma: m8-10-11-12-13-14-17-19

1/2"	UZUN	TF-008-1 TD-410M1
10 p.	ALTIKÖŞE: 10-24mm	\$71,70

Uzun Lokma: m10-12-13-14-16-17-19-21-22-24

1/2"	UZUN	TD-413M
13 p.	ALTIKÖŞE: 10-30mm	\$100,00

Kısa Lokma: m10-11-12-13-14-16-17-19-21-22-24-27-30

1/2"	UZUN	TD-410S
10 p.	ALTIKÖŞE: 7/16"-1"	\$71,70

Kısa Lokma: 7/16-1/2-9/16-5/8-11/16-3/4-13/16-7/8-15/16-1"

1/2"	UZUN	TD-413S
13 p.	ALTIKÖŞE: 7/16"-1.1/4	\$100,00

Kısa Lokma: 7/16-1/2-9/16-5/8-11/16-3/4-13/16-7/8-15/16-1  
1.1/16-1.1/8-1.1/4

# GENIUS

## HAVALI LOKMA TAKIMI



1/2"	KISA	CM-417MB
17 p.	ALTIKÖŞE: 8-32mm	\$70,30
Kısa Lokma: m8-10-11-12-13-14-15-16-17-18-19-21-22-24-27-30-32		

1/2"	KISA	TF-417MB
17 p.	ALTIKÖŞE: 8-32m	\$70,30
Kısa Lokma: m8-10-11-12-13-14-15-16-17-18-19-21-22-24-27-30-32		

3/4"	KISA	IS-609E
9 p.	ALTIKÖŞE: 19-36mm	\$117,10
Kısa Lokma: m19-22-24-27-30-32-33-34-36		

3/4"	KISA	IS-617E
17 p.	ALTIKÖŞE: 19-55mm	\$263,80
Kısa Lokma: m19-21-22-24-27-30-32-33-34-35-36-38-40-41-46-50-55		

3/4"	KISA	IS-617S
17 p.	ALTIKÖŞE: 1"-2"	\$327,90
Kısa Lokma: 1-1,11/16-1,1/8-1,3/16-1,1/4-1,5/16-1,3/8-1,7/16-1,1/2-1,9/16-1,5/8-1,11/16-1,3/4-1,13/16-1,7/8-1,15/16-2		

3/4"	KISA	IS-617M
17 p.	ALTIKÖŞE: 26-46mm	\$250,00
Kısa Lokma: m26-27-28-29-30-31-32-33-34-35-36-37-38-40-41-43-46		

1"	KISA	IS-817S
17 p.	ALTIKÖŞE: 1.7/16-3.1/8	\$963,30
Kısa Lokma: 1,7/16-1,1/2-1,5/8-1,11/16-1,3/4-1,13/16-1,7/8-2"-2,1/8-2,3/16-2,1/4-2,3/8-2,1/2-2,5/8-2,3/4-2,15/16-3,1/8		

## HAVALI LOKMA TAKIMI



3/4"	UZUN	DI-621M
21 p.	ALTIKÖŞE: 19-50mm	\$488,90
Uzun Lokma: m19-21-22-23-24-27-29-30-32-33-35-36-38-40-41-42-43-45-46-48-50		

## HAVALI LOKMA TAKIMI



1/2"	KISA	TF-416M
16 p.	ALTIKÖŞE: 8-27mm	\$114,80
Kısa Lokma: m8-10-11-12-13-14-16-17-19-21-22-24-27		
Cırcır kol (1)-Mafsal kol (1)-Uzatma (1)		

## ALTIKÖŞE KROMAJLI LOKMA TAKIMI



1/4"	KISA-UZUN	GS-244MS
44 p.	ALTIKÖŞE: 3-14mm ALTIKÖŞE: 3/16"-9/16"	\$70,20

Kısa Lokma: m3-4-5-5-5-6-7-8-9-10-11-12-143-14  
3/16-7/32-1/4-9/32-5/16-11/32-3/8-7/16-1/2-9/16  
Uzun Lokma: m5,5-6-7-8-9-10-11-12-13-14  
1/4-9/32-5/16-11/32-3/8-7/16-1/2-9/16  
Circir kol (1)-Uzatma (2)

## ALTIKÖŞE KROMAJLI LOKMA TAKIMI



1/4"	KISA	GS-237S
37 p.	ALTIKÖŞE: 1/8"-9/16" KARE: 1/4"-3/8"	\$63,80

Kısa Lokma: 1/8-3/16-7/32-1/4-9/32-5/16-11/32-3/8-7/16  
1/2-9/16  
Kare lokma: 1/4-5/16-3/8  
Lokmalı düz uç (6)-Lokmalı Yıldız uç (4)-Lokmalı allen uç (8)  
T kolu (1)-Uzatma (1)-Lokma sapı (1)-Circir kol (1)-Ara mafsalsal (1)

## ALTIKÖŞE KROMAJLI LOKMA TAKIMI



1/4"	KISA	GS-219M
19 p.	ALTIKÖŞE: 4-12mm KARE: 8-10mm	\$49,90

Kısa Lokma: m4-4,5-5-5,5-6-7-8-9-10-11-12  
Kare Lokma: m8-10 Circir kol (1)  
T kolu (1)-Uzatma (2)-Lokma sapı (1)-Ara mafsalsal (1)

1/4"	KISA	GS-220M
20 p.	ALTIKÖŞE: 3-12mm KARE: 8-10mm	\$55,70

Kısa Lokma: m3-4-4,5-5-5,5-6-7-8-9-10-11-12  
Kare Lokma: m8-10 Circir kol (1)  
T kolu (1)-Uzatma (2)-Lokma sapı (1)-Ara mafsalsal (1)-Mafsalsal kol (1)

## ALTIKÖŞE KROMAJLI LOKMA TAKIMI



1/4"	KISA-UZUN	GS-255MS
55 p.	ALTIKÖŞE: 3-14mm ALTIKÖŞE: 1/8"-9/16"	\$104,40

Kısa Lokma: m3-4-4,5-5-5,5-6-7-8-9-10-11-12-13-14  
1/8-3/16-7/32-1/4-9/32-5/16-11/32-3/8-7/16-1/2-9/16  
Uzun Lokma: m4-4,5-5-5,5-6-7-8-9-10-11-12-13-14  
3/16-7/32-1/4-9/32-5/16-11/32-3/8-7/16-1/2-9/16  
Uzatma (4)-Ara mafsalsal (1)-Adaptör (1)-Uç Ad.(1)

## ALTIKÖŞE KROMAJLI LOKMA TAKIMI



1/4"	KISA	EU-228M
28 p.	ALTIKÖŞE: 4-13mm	\$65,00

Kısa Lokma: m4-5-5,5-6-7-8-9-10-11-12-13  
 Düz Uç:m4-6-7 Yıldız Uç:Ph1-2-3 Allen Uç:m3-4-5-6  
 Bits uç adaptörü (1)  
 T kolu (1)-Uzatma (2)-Lokma sapı (1)  
 Mafsal (1)-Circir kol (1)-Ara mafsal (1)

1/4"	KISA	EU-228S
28 p.	ALTIKÖŞE: 1/8"-9/16"	\$69,60

Kısa Lokma: 1/8-3/16-7/32-1/4-9/32-5/16-11/32-3/8-7/16-1/2-9/16  
 Düz Uç:m4-6-7 Yıldız Uç:Ph1-2-3 Allen Uç:1/8-5/32-3/16-7/32  
 Bits uç adaptörü (1)  
 T kolu (1)-Uzatma (2)-Lokma sapı (1)  
 Mafsal (1)-Circir kol (1)-Ara mafsal (1)

## ALTIKÖŞE KROMAJLI LOKMA TAKIMI

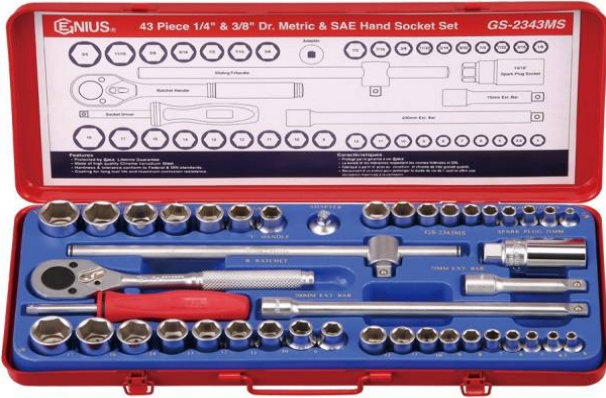

## ALTIKÖŞE KROMAJLI LOKMA TAKIMI



1/4"	KISA-UZUN	GS-221M
21 p.	ALTIKÖŞE: 5-13mm	\$70,00

Kısa Lokma: m5-5,5-6-7-8-9-10-11-12-13  
 Uzun Lokma: m6-7-8-9-10-11-12-13  
 Circir kol (1)-Uzatma (1)-Lokma sapı (1)

## ALTIKÖŞE KROMAJLI LOKMA TAKIMI

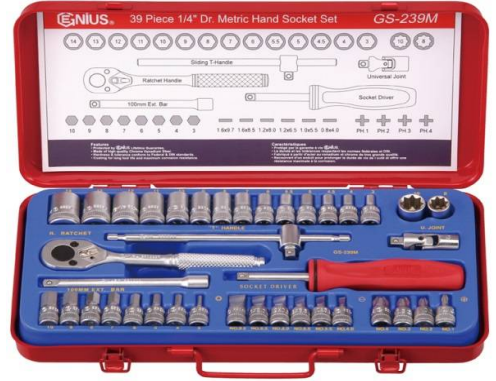

1/4"	KISA	GS-239M
39 p.	ALTIKÖŞE: 3-14mm KARE: 8-10mm	\$68,50

Kısa Lokma: m3-4-4,5-5-5,5-6-7-8-9-10-11-12-13-14  
 Kare lokma: m8-10  
 Lokmalı düz uç (6)-Lokmalı Yıldız uç (4)-Lokmalı allen uç (8)  
 T kolu (1)-Uzatma (1)-Lokma sapı (1)-Circir kol (1)-Ara mafsal (1)

1/4" 3/8"	KISA	GS-2343MS
43 p.	ALTIKÖŞE: 4-19mm ALTIKÖŞE: 1/8"-3/4"	\$100,20

1/4" Kısa Lokma: m4-4,5-5-6-7-8-9-10-11-12  
 1/8-3/16-7/32-1/4-9/32-5/16-11/32-3/8-7/16-1/2  
 3/8" Kısa Lokma: m9-10-11-12-13-14-16-17-19  
 3/8-7/16-1/2-9/16-5/8-11/16-3/4  
 T kolu (1)-Uzatma (2)-Lokma sapı (1)  
 Circir kol (1)-Adaptör (1)-Buji lokması (1)

## YILDIZ KROMAJLI LOKMA TAKIMI



3/8"	KISA-UZUN	AC-359
59 p.	YILDIZ: 6-22mm	\$113,50

Kısa Lokma: m6-7-8-9-10-11-12-13-14-15-16-17-18-19-20-21-22  
 Uzun Lokma: m8-10-11-12-13-14-15-17-19  
 Allen bits uç (6)-Yıldız bits uç (6)-Büz bits u (3)  
 Delikli torx bits uç (9)-Uç adp.(1)  
 Uzatma (2)-Bits uç sapı (1)-Circir kol (1)  
 Adaptör (1)-Buji lokması (2)-Ara mafsal (1)

## YILDIZ KROMAJLI LOKMA TAKIMI



3/8"	UZUN	TW-316MD
16 p.	YILDIZ: 6-21mm	\$63,80

Uzun Lokma: m6-7-8-9-10-11-12-13-14-15-16-17-18-19-20-21

## ALTIKÖŞE KROMAJLI LOKMA TAKIMI



3/8"	UZUN	GS-313M
13 p.	ALTIKÖŞE: 8-19mm	\$70,20

Uzun Lokma: m8-10-11-12-13-14-17-19  
Circir kol (1)-Uzatma (2)-Buji lokması (2)

3/8"	UZUN	GS-313S
13 p.	ALTIKÖŞE: 5/16"-3/4"	\$88,10

Uzun Lokma: 5/16-3/8-7/16-1/2-9/16-5/8  
11/16-3/4 Circir kol (1)-Uzatma (2)-Buji lok.(2)

## ALTIKÖŞE KROMAJLI LOKMA TAKIMI



3/8"	KISA-UZUN	GS-347MS
47 p.	ALTIKÖŞE: 6-19mm ALTIKÖŞE: 1/4"/7/8"	\$126,80

Kısa Lokma: m6-7-8-9-10-11-12-13-14-15-16-17-18-19  
1/4-5/16-3/8-7/16-1/2-9/16-5/8-11/16-3/4-13/16-7/8  
Uzun Lokma: m10-11-12-13-14-15-16-17-18-19  
3/8-7/16-1/2-9/16-5/8-11/16-3/4-13/16-7/8  
Uzatma (2)-Circir kol (1)

## ALTIKÖŞE KROMAJLI LOKMA TAKIMI

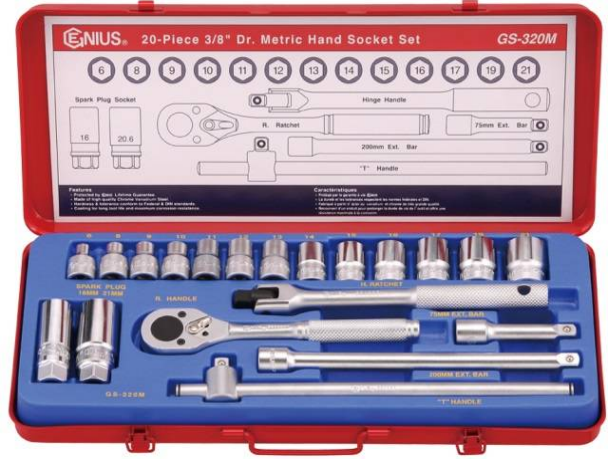

3/8"	KISA	GS-320M
20 p.	ALTIKÖŞE: 6-21mm	\$102,80

Kısa Lokma: m6-8-9-10-11-12-13-14-15-16-17-19-21

Circir kol (1)-Uzatma (2)-T kolu (1)-Mafsal kol (1)-Buji lokması (2)

3/8"	KISA	GS-320S
20 p.	ALTIKÖŞE: 1/4"-7/8"	\$104,10

Kısa Lokma: 1/4-5/16-3/8-7/16-1/2-9/16

19/32-5/8-11/16-3/4-25/32-13/16-7/8

Circir kol (1)-Uzatma (2)-T kolu (1)-Mafsal kol (1)-Buji lokması (2)

## ALTIKÖŞE KROMAJLI LOKMA TAKIMI



3/8"	KISA	GS-318M2
18 p.	ALTIKÖŞE: 6-22mm	\$77,40

Kısa Lokma: m6-7-8-10-11-12-13-14-15-16-17-19-22

Circir kol (1)-Uzatma (2)-Buji lokması (1)-T kolu (1)

3/8"	KISA	GS-319M1
18 p.	ALTIKÖŞE: 6-21mm	\$77,40

Kısa Lokma: m6-7-8-10-11-12-13-14-15-16-17-19-21

Circir kol (1)-Uzatma (2)-Buji lokması (1)-T kolu (1)

## ALTIKÖŞE KROMAJLI LOKMA TAKIMI



3/8"

KISA

EU-319M

19 p.

ALTIKÖŞE: 8-22mm

\$98,20

Kısa Lokma: m8-9-10-11-12-13-14-15-16-17-19-21-22  
Circir kol (1)-Uzatma (3)-Ara mafsal (1)

## ALTIKÖŞE KROMAJLI LOKMA TAKIMI



3/8"

KISA-UZUN

GS-331M

31 p.

ALTIKÖŞE: 8-19mm

\$131,50

Kısa Lokma: m8-9-10-11-12-13-14-15-16-17-18-19  
Uzun Lokma: m8-9-10-11-12-13-14-15-16-17-18-19  
Uzatma (3)-Circir kol (1)-Mafsal kol (1)-Ara mafsal (1)

## YILDIZ KROMAJLI LOKMA TAKIMI



1/2"

KISA

EU-421S

21 p.

YILDIZ: 3/8"-1.1/4"

\$175,00

Kısa Lokma: 3/8-7/16-1/2-9/16-19/32-5/8-11/16-3/4-13/16  
7/8-15/16-1.1/16-1.1/8-1.3/16-1.1/4  
Circir kol (1)-Uzatma (2)-T kolu (1)-Ara mafsal (1)

## YILDIZ KROMAJLI LOKMA TAKIMI



1/2"

KISA

TW-424M

24 p.

YILDIZ: 8-32mm

\$117,20

Kısa Lokma: m8-9-10-11-12-13-14-15-16-17-18-19-21-22-24-27  
30-32  
Circir kol (1)-Uzatma (2)-T kolu (1)-Ara mafsal (1)-Buji lokması (1)

## ALTIKÖŞE KROMAJLI LOKMA TAKIMI



1/2"

KISA

GS-417M

17 p.

ALTIKÖŞE: 10-32mm

\$97,60

Kısa Lokma: m10-11-12-13-14-15-17-19-22-24-27-30-32  
Circir kol (1)-Uzatma (1)-T kolu (1)-Ara mafsal (1)

1/2"

KISA

GS-417S

17 p.

ALTIKÖŞE: 3/8"-1.1/4"

\$124,20

Kısa Lokma: 3/8-7/16-1/2-9/16-5/8-11/16-3/4-13/16-7/8-15/16  
1-1/8-1,1/4-13/16-7/8  
Circir kol (1)-Uzatma (1)-T kolu (1)-Ara mafsal (1)

## ALTIKÖŞE KROMAJLI LOKMA TAKIMI



1/2"	KISA	GS-422M
22 p.	ALTIKÖŞE: 9-32mm	\$117,40

Kısa Lokma: m9-10-12-13-14-15-16-17-18-19-21-23-25-26-29-32  
Circir kol (1)-Uzatma (2)-T kolu (1)-Ara mafsal (1)-Buji lokması (1)

1/2"	KISA	GS-422M2
22 p.	ALTIKÖŞE: 10-32mm	\$117,40

Kısa Lokma: m10-11-12-13-14-15-16-17-19-20-21-22-24-27-30-32  
Circir kol (1)-Uzatma (2)-T kolu (1)-Ara mafsal (1)-Buji lokması (1)

1/2"	KISA	GS-422M3
22 p.	ALTIKÖŞE: 8-32mm	\$117,40

Kısa Lokma: m8-10-11-12-13-14-15-16-17-18-19-22-24-27-30-32  
Circir kol (1)-Uzatma (2)-T kolu (1)-Ara mafsal (1)-Buji lokması (1)

1/2"	KISA	GS-422M4
22 p.	ALTIKÖŞE: 8-32mm	\$117,40

Kısa Lokma: m8-10-11-12-13-14-15-16-17-19-21-22-24-27-30-32  
Circir kol (1)-Uzatma (2)-T kolu (1)-Ara mafsal (1)-Buji lokması (1)

1/2"	KISA	GS-422S
22 p.	ALTIKÖŞE: 3/8"-1.1/4"	\$129,30

Kısa Lokma: 3/8-7/16-1/2-9/16-19/32-5/8-21/32-11/16-3/4-25/32  
13/16-7/8-15/16-1.1/8-1.1/4  
Circir kol (1)-Uzatma (2)-T kolu (1)-Ara mafsal (1)-Buji lokması (1)

## ALTIKÖŞE KROMAJLI LOKMA TAKIMI



## ALTIKÖŞE KROMAJLI LOKMA TAKIMI



1/2"	KISA	GS-427M
27 p.	ALTIKÖŞE: 10-32mm	\$159,80

Kısa Lokma: m10-11-12-13-14-15-16-17-18-19-21-22-23-24-27  
28-30-32

Circir kol (1)-Uzatma (2)-T kolu (1)-Ara mafsal (1)-Mafsal kol (1)  
Buji lokması (1)-Mafsal kol sapı (1)

1/2"	KISA	GS-427S
27 p.	ALTIKÖŞE: 5/16"-1.1/4"	\$159,80

Kısa Lokma: 5/16-3/8-7/16-1/2-9/16-19/32-5/8-21/32-11/16  
3/4-25/32-13/16-7/8-15/16-1.1/8-1.1/16-1.1/8-1.3/16-1.1/4

Circir kol (1)-Uzatma (2)-T kolu (1)-Ara mafsal (1)-Mafsal kol (1)  
Buji lokması (1)-Mafsal kol sapı (1)

## ALTIKÖŞE KROMAJLI LOKMA TAKIMI



1/2"	KISA	GS-424M3
24 p.	ALTIKÖŞE: 10-32mm	\$134,60

Kısa Lokma: m10-11-12-13-14-15-16-17-18-19-21-22-23-24-27-30-32  
Circir kol (1)-Uzatma (2)-T kolu (1)-Ara mafsal (1)-Mafsal kol (1)  
Buji lokması (1)

1/2"	KISA	EU-426M
26 p.	ALTIKÖŞE: 10-34mm	\$175,00

Kısa Lokma: m10-11-12-13-14-15-16-17-18-19-20-21-22-23-24  
26-27-28-30-32-34

Circir kol (1)-Uzatma (2)-T kolu (1)-Ara mafsal (1)

## ALTIKÖŞE KROMAJLI LOKMA TAKIMI



1/2"	KISA	GS-424M4
24 p.	ALTIKÖŞE: 8-32mm	\$139,60

Kısa Lokma: m8-10-11-12-13-14-15-16-17-18-19-21-22-24-27-30-32  
Circir kol (1)-Uzatma (2)-T kolu (1)-Ara mafsal (1)-Firdöndü (1)

## ALTIKÖŞE KROMAJLI LOKMA TAKIMI



1/2"	KISA	GS-424S
24 p.	ALTIKÖŞE: 5/16"-1.1/4"	\$129,30

Kısa lokma: 5/16-3/8-7/16-1/2-9/16-19/32-5/8-11/16-3/4  
25/32-13/16-7/8-15/16-1-1,1/16-1,1/8-1,3/16-1,1/4  
Circir kol (1)-Uzatma (2)-T kolu (1)-Ara mafsal (1)-Buji lokması (1)

## ALTIKÖŞE KROMAJLI LOKMA TAKIMI



1/2"	KISA	GS-425S
24 p.	ALTIKÖŞE: 5/16"-1.1/4"	\$129,30

Kısa lokma: 5/16-3/8-7/16-1/2-9/16-19/32-5/8-11/16-3/4  
25/32-13/16-7/8-15/16-1-1,1/16-1,1/8-1,3/16-1,1/4  
Circir kol (1)-Uzatma (2)-Buji lokması (1)-Ara mafsal (1)  
Mafsal kol (1)

## ALTIKÖŞE KROMAJLI LOKMA TAKIMI



1/2"	KISA	GS-446MS
46 p.	ALTIKÖŞE: 8-32mm ALTIKÖŞE: 3/8"-1.1/4"	\$233,80

Kısa lokma: m8-9-10-11-12-13-14-15-16-17-18-19-20-21-22-23  
24-25-26-27-28-30-32  
3/8-7/16-1/2-9/16-5/8-11/16-3/4-13/16-7/8-15/16-1-1,1/8  
1,3/16-1,1/4  
Circir kol (1)-Uzatma (2)-Buji lokması (2)-Ara mafsal (1)  
Mafsal kol (1)-Mafsal kol sapı (1)-T kolu (1)

## YILDIZ KROMAJLI LOKMA TAKIMI

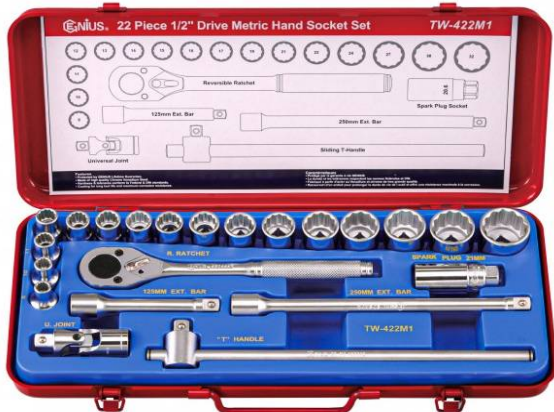

1/2"	KISA	TW-422M1
22 p.	YILDIZ: 8-32mm	\$117,20

Kısa Lokma: m8-10-11-12-13-14-15-16-17-19-21-22-24-27-30-32  
Circir kol (1)-Uzatma (2)-T kolu (1)-Ara mafsal (1)-Buji lokması (1)

## ALTIKÖŞE KROMAJLI LOKMA TAKIMI



3/4"	KISA	EU-615M
15 p.	ALTIKÖŞE: 22-50mm	\$345,60

Kısa lokma: m22-24-27-30-32-33-34-36-41-46-50  
Circir kol (1)T kolu (1)-Uzatma (2)

## ALTIKÖŞE KROMAJLI LOKMA TAKIMI



3/4"	KISA	GS-615M
15 p.	ALTIKÖŞE: 27-63mm	\$326,90

Kısa lokma: m27-30-32-33-35-36-38-41-46-50-55-60-63  
T kolu (1)-Uzatma (1)

3/4"	KISA	GS-615S
15 p.	ALTIKÖŞE: 1"-2.1/2"	\$326,90

Kısa Lokma: 1-1,1/8-1,1/4-1,3/8-1,1/2-1,5/8-1,3/4-1,7/8-2-2,1/8  
2,1/4-2,3/8-2,1/2  
T kolu (1)-Uzatma (1)

## ALTIKÖŞE KROMAJLI LOKMA TAKIMI



3/4"	KISA	GS-617M
17 p.	ALTIKÖŞE: 21-50mm	\$386,90

Kısa lokma: m21-22-23-24-27-30-32-35-36-38-41-46-50  
Circir kol (1)T kolu (1)-Uzatma (2)

3/4"	KISA	GS-617AS
17 p.	ALTIKÖŞE: 7/8"-2"	\$393,60

Kısa Lokma: 7/8-15/16-1-1,1/16-1,1/8-1,1/4-1,3/8-1,7/16-1,1/2  
1,5/8-1,3/4-1,7/8-2  
Circir kol (1)T kolu (1)-Uzatma (2)

## ALTIKÖŞE KROMAJLI LOKMA TAKIMI



3/4"	KISA	GS-627M
27 p.	ALTIKÖŞE: 17-60mm	\$416,30

Kısa lokma: m17-19-20-21-22-23-24-27-30-31-32-33-34-35-36-37-38  
40-41-45-46-48-50-54-55-57-60

3/4"	KISA	GS-627S
27 p.	ALTIKÖŞE: 3/4"-2.3/8"	\$464,30

Kısa lokma: 3/4-25/32-13/16-7/8-15/16-1"-1,1/16-1,1/8-1,3/16-1,1/4  
1,5/16-1,3/8-1,7/16-1,1/2-1,9/16-1,5/8-1,11/16-1,3/4-1,13/16-1,7/8  
1,15/16-2"-2,1/16-2,1/8-2,3/16-2,1/4-2,3/8

## YILDIZ KROMAJLI LOKMA TAKIMI



3/4"	KISA	TW-617M
17 p.	YILDIZ: 21-50mm	\$393,60

Kısa lokma: m21-22-23-24-27-30-32-35-36-38-41-46-50  
Circir kol (1)T kolu (1)-Uzatma (2)

3/4"	KISA	TW-617S
17 p.	YILDIZ: 7/8"-2"	\$527,00

Kısa Lokma: 7/8-15/16-1-1,1/16-1,1/8-1,1/4-1,3/8-1,7/16-1,1/2  
1,5/8-1,3/4-1,7/8-2  
Circir kol (1)T kolu (1)-Uzatma (2)

3/4"	KISA	TW-615S6
15 p.	YILDIZ: 15/16"-1.7/8"	\$327,00

Kısa Lokma: 5/16-1-1,1/8-1,1/4-1,5/16-1,3/8-1,7/16-1,1/2  
1,5/8-1,3/4-1,7/8  
Circir kol (1)T kolu (1)-Uzatma (2)

## ALTIKÖŞE-YILDIZ KROMAJLI LOKMA TAKIMI



3/4"	KISA	TW-625M
25 p.	YILDIZ: 19-55mm	\$466,00

Kısa Lokma: m19-21-22-23-24-27-28-29-30-32-33-34-35-36-38-41-46  
50-55  
Circir kol (1)-T kolu (1)-Uzatma (2)-Mafsal kol (1)

3/4"	KISA	TW-628MS
28 p.	YILDIZ: 22-50mm ALTIKÖŞE: 7/8"-2"	\$509,60

Kısa yıldız lokma: m22-24-27-30-32-36-38-41-46-50  
Kısa altıköşe lokma: 7/8-15/16-1-1,1/8-1,3/16-1,5/16-1,3/8  
1,7/16-1,5/8-1,3/4-1,7/8-2  
Circir kol (1)-T kolu (1)-Uzatma (2)-Mafsal kol (1)



## ALTIKÖŞE KROMAJLI LOKMA TAKIMI



1"	KISA	GS-815M1
15 p.	ALTIKÖŞE: 30-65mm	\$660,00

Kısa lokma: m30-32-33-35-36-38-41-46-50-55-60-65  
Circir kol (1)-Uzatma (2)

1"	KISA	GS-816M1
16 p.	ALTIKÖŞE: 36-80mm	\$920,50

Kısa lokma: m36-38-41-43-46-50-55-60-65-70-75-80  
Circir kol (1)-T kolu (1)-Uzatma (2)

1"	KISA	GS-816S6
16 p.	ALTIKÖŞE: 1.7/16"-3.1/8"	\$1.053,90

Kısa lokma: 1,7/16-1,1/2-1,11/16-1,7/8-2-2,1/4-2,3/8-2,1/2  
2,5/8-2,3/4-2,15/16-3,1/8  
Circir kol (1)-T kolu (1)-Uzatma (2)

1"	KISA	GS-815S
15 p.	ALTIKÖŞE: 1.1/8"-2.1/2"	\$920,50

Kısa lokma: 1,1/8-1,1/4-1,3/8-1,1/2-1,5/8-1,3/4-1,7/8-2-2,1/8-2,1/4  
2,3/8-2,1/2  
Circir kol (1)-Uzatma (2)

## ALTIKÖŞE KROMAJLI LOKMA TAKIMI



1"	KISA	GS-817M
17 p.	ALTIKÖŞE: 24-75mm	\$501,60

Kısa lokma: m24-27-30-32-33-35-36-38-41-46-50-54-55-60-65-70-75

1"	KISA	GS-817S
17 p.	ALTIKÖŞE: 1.7/16"-3.1/8"	\$780,50

Kısa lokma: 1,7/16-1,1/2-1,5/8-1,11/16-1,3/4-1,13/16-1,7/8-2,2,1/8-2,3/16-2,1/4-2,3/8-2,1/2-2,5/8-2,3/4-2,15/16-3,1/8

## YILDIZ KROMAJLI LOKMA TAKIMI



1"	KISA	TW-816M1
16 p.	YILDIZ: 36-80mm	\$1.053,90

Kısa lokma: m36-38-41-43-46-50-55-60-65-70-75-80  
Circir kol (1)-T kolu (1)-Uzatma (2)

1"	KISA	TW-815S
15 p.	YILDIZ: 1.1/2"-2.1/2"	\$1.196,70

Kısa lokma: 1,1/8-1,1/4-1,3/8-1,1/2-1,5/8-1,3/4-1,7/8-2-2,1/8-2,1/4-2,3/8-2,1/2  
Circir kol (1)-Uzatma (2)

## KROMAJLI TORX LOKMA TAKIMI



1/4"	KISA	TX-23414
3/8"	TORX: E.4-E.24	\$53,40
1/2"		
14 p.		

1/4" Kısa torx lokma: E.4-5-6-7-8

3/8" Kısa torx lokma: E.10-11-12-14-16

1/2" Kısa torx lokma: E.18-20-22-24

## KROMAJLI TORX LOKMA TAKIMI



1/2"	KISA	TX-409
9 p.	TORX: E.10-E.24	\$54,60

Kısa torx lokma: E.10-11-12-14-16-18-20-22-24

## KROMAJLI TORX LOKMA TAKIMI



1/4"	KISA	TX-2319
3/8"	TORX: E.4-E.20	\$80,10
19 p.		

1/4" Kısa torx lokma: E.4-5-6-7-8-10-11

3/8" Kısa torx lokma: E.10-11-12-14-16-18-20

Circir kol (1)-Uzatma (2)-Adaptör (1)-Mafsallı lokma sapı (1)

## HAVALI ALTIKÖŞE LOKMALI ALLEN TAKIMI



3/8"	KISA	TH-310M
10 p.	ALTIKÖŞE: 4-17mm	\$73,00

Lokmalı Allen: m4-5-6-7-8-10-12-14-16-17

3/8"	KISA	TH-310S
10 p.	ALTIKÖŞE: 5/32"-5/8"	\$83,00

Lok. Allen: 5/32-3/16-7/32-1/4-5/16-3/8-7/16-1/2-9/16-5/8

## HAVALI ALTIKÖŞE LOKMALI ALLEN TAKIMI



3/8"	KISA	TH-312M
12 p.	ALTIKÖŞE: 4-17mm	\$106,80

Lokmalı Allen: m4-5-6-7-8-10-12-14-16-17

Circir kol (1)-T kolu (1)

3/8"	KISA	TH-312S
12 p.	ALTIKÖŞE: 5/32"-5/8"	\$116,80

Lok. Allen: 5/32-3/16-7/32-1/4-5/16-3/8-7/16-1/2-9/16-5/8

Circir kol (1)-T kolu (1)

## HAVALI ALTIKÖŞE LOKMALI ALLEN TAKIMI



1/2"	KISA	TH-408MD
8 p.	ALTIKÖŞE: 5-19mm	\$73,60

Lokmalı Allen: m5-6-8-10-12-14-17-19

1/2"	KISA	TH-410S
10 p.	ALTIKÖŞE: 3/16"-3/4"	\$101,60

Lok. Allen: 3/16-7/32-1/4-5/16-3/8-7/16-1/2-9/16-5/8-3/4

## HAVALI ALTIKÖŞE LOKMALI ALLEN TAKIMI



1/2"	KISA	TH-412H
12 p.	ALTIKÖŞE: 5-19mm	\$121,20

Lokmalı Allen: m4-5-6-8-10-12-14-17-19

Circir kol (1)-T kolu (1)-Uzatma (1)

1/2"	KISA	TH-412S
12 p.	ALTIKÖŞE: 5/32"-3/4"	\$132,40

Lokmalı Allen: 5/32-3/16-1/4-5/16-3/8-7/16-1/2-5/8-3/4

Circir kol (1)-T kolu (1)-Uzatma (1)

## HAVALI ALTIKÖŞE LOKMALI ALLEN TAKIMI



1/2"	KISA	TH-408M
8 p.	ALTIKÖŞE: 5-19mm	\$73,60

Lokmalı Allen: m5-6-8-10-12-14-17-19

1/2"	KISA	TH-408S
8 p.	ALTIKÖŞE: 3/16"-3/4"	\$84,80

Lokmalı Allen: 3/16-1/4-5/16-3/8-7/16-9/16-11/16-3/4

## HAVALI LOKMALI TORX ALLEN TAKIMI



1/2"	KISA	TX-415
15 p.	TORX: T.7-T.70	\$155,00

Lokmalı Torx Allen: T.10-15-20-25-27-30-40-45-50-55-60-70  
Circir kol (1)-T kolu (1)-Uzatma (1)

## KROMAJLI ALTIKÖŞE LOKMALI ALLEN TAKIMI



1/2"	KISA	BS-409H
9 p.	ALTIKÖŞE: 4-17mm	\$45,30

Altıköşe lokmalı allen: m4-5-6-7-8-10-12-14-17 (80mm)

## KROMAJLI LOKMALI TORX ALLEN TAKIMI



1/2"	KISA	BS-409T
9 p.	TORX: T.20-T.60	\$56,30

Torx lokmalı allen: T.20-25-27-30-40-45-50-55-60 (80mm)

## BİTS UÇ TAKIMLARI



5/16"-Arkalı 33 p.	SC-233	\$63,80
-----------------------	--------	---------

Allen uç: m3-4-5-6-7-8 (30mm)  
1/8-5/32-3/16-7/32-1/4-9/32-5/16 (30mm)  
Torx uç: T.10-15-20-25-27-30-40-45-50 (30mm)  
Düz uç: 5.5-5.6-7 (72mm)  
Yıldız uç: Ph1-2-3-4 (72mm)  
3/8"Uzatma (1)-3/8"Circir (1)-Bits uç adp.(1)



10mm-Arkalı 40 p.	TX-3440	\$51,20
----------------------	---------	---------

10mmAllen uç: m4-5-6-7-8-10-12 (30mm)  
10mmAllen uç: m4-5-6-7-8-10-12 (75mm)  
10mmTorx uç: T.20-25-30-40-45-50-55 (30mm)  
10mmTorx uç: T.20-25-30-40-45-50-55 (75mm)  
10mmYıldız uç: m5-6-8-10-12 (30mm)  
10mmYıldız uç: m5-6-8-10-12 (75mm)  
Bits uç adp. (2)

## TORX BİTS UÇ TAKIMI

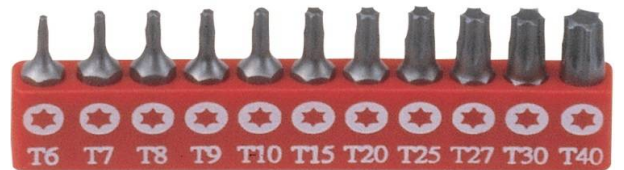

1/4"-Arkalı 11 p.	SB-711TP	\$7,00
----------------------	----------	--------

Torx uç: T.6-7-8-9-10-15-20-25-27-30-40

# GENIUS

## KROMAJLI TORX-YILDIZ-ALTIKÖŞE LOKMALI ALLEN TAKIMI



3/8" 1/2" 16 p.	UZUN ALTIKÖŞE: 6-17mm TORX: T.55 YILDIZ: 8-12mm	TH-3416 \$91,70
-----------------------	--	--------------------

3/8" Altıköşe lokmalı allen: 6 (uzun)-6,7,8 (ex.uzun)  
3/8" Yıldız lokmalı allen: 8 (uzun)-10,12 (ex.uzun)  
1/2" Altıköşe lokmalı allen: 12,17 (kısa)-5,6,8,10 (uzun)  
6,8 (ex.uzun)  
1/2" Lokmalı torx allen: T.55 (uzun)

## KARIŞIK TORX TAKIM



40.p	TX-23440	\$104,40
------	----------	----------

1/4" Dişi torx lokma: E.4-5-6-7-8  
3/8" Dişi torx lokma: E.10-12-14-16-18-20  
Torx allen: T.9-10-15-20-25-27-30-40-45-50-55-60-70  
1/4" Allen uç: T.9-10-15-20 (30mm)  
10mm Allen uç: T.25-27-30-40-45-50 (30mm)  
14mm Allen uç: T.55 (115mm)-60-70 (75mm)  
Bits uç adap. (3)

## KARIŞIK TORX TAKIM



1/4" 3/8" 1/2" 41 p.	KISA TORX: T.7-T.70 E.4-E.20	BS-23441 \$184,50
-------------------------------	------------------------------------	----------------------

1/4" Torx lokma: E.4-5-6-7-8  
3/8" Torx lokma: E.10-11-12-14-16  
1/2" Torx lokma: E.18-20  
1/4" Lokmalı torx allen: T.7-8-9-10-15-20-25-27-30  
3/8" Lokmalı torx allen: T.40-45-50-55  
1/2" Lokmalı torx allen: T.60-70  
1/4" Lokmalı delikli torx allen: T.8-9-10-15-20-25-27-30  
3/8" Lokmalı delikli torx allen: T.40-45-50-55  
1/2" Lokmalı delikli torx allen: T.60-70

## CIRCIRLI KOMBİNE ANAHTAR



Ölçü	Boy/mm	
8mm	135	\$9,30
9mm	142	\$9,40
10mm	158	\$10,20
11mm	167	\$10,20
12mm	173	\$11,10
13mm	179	\$11,40
14mm	189	\$12,00
15mm	199	\$12,30
16mm	215	\$13,50
17mm	232	\$13,50
18mm	238	\$14,00
19mm	247	\$15,00
20mm	285	\$22,70
21mm	285	\$23,30
22mm	285	\$23,30
24mm	325	\$28,80
27mm	355	\$36,50
28mm	355	\$44,70
30mm	425	\$44,70
32mm	425	\$44,70



Ölçü	Boy/mm	
17mm	128	\$13,50

## KOMBİNE ANAHTAR



Ölçü	Boy/mm	
24mm	320	\$12,60
27mm	370	\$16,80
28mm	360	\$17,40
30mm	410	\$19,50
32mm	430	\$20,90
34mm	461	\$29,30
35mm	461	\$39,30
36mm	486	\$39,30
38mm	486	\$46,00
41mm	540	\$49,80
46mm	611	\$56,30
50mm	611	\$64,80
55mm	666	\$154,20
60mm	760	\$202,60
65mm	760	\$202,60

# GENIUS

## KOMBİNE ANAHTAR TAKIMI



7 -19mm 11.p	HS-011M	\$48,80
m7-8-9-10-11-12-13-14-15-17-19		

1/4"-7/8" 11.p	HS-011S	\$71,00
1/4-5/16-3/8-7/16-1/2-9/16-5/8-11/16-3/4-13/16-7/8		

## KOMBİNE ANAHTAR TAKIMI



6-32mm 24.p	HS-024M	\$173,80
m6-7-8-9-10-11-12-13-14-15-16-17-18-19-20-21-22-23-24 25-26-27-30-32		

6-32mm 26.p	PR-026M	\$251,90
m6-7-8-9-10-11-12-13-14-15-16-17-18-19-20-21-22-23-24 25-26-27-28-29-30-32		

6-32mm 16.p	HS-016M	\$132,30
m6-7-8-9-10-11-12-13-14-17-19-22-24-27-30-32		

6-22mm 17.p	PR-017M	\$100,20
m6-7-8-9-10-11-12-13-14-15-16-17-18-19-20-21-22		

5/16"-1" 11.p	PR-011S	\$112,80
5/16-3/8-7/16-1/2-9/16-5/8-11/16-3/4-7/8-15/16-1"		

1/4"-1,1/4" 16.p	HS-016S	\$125,10
1/4-5/16-3/8-7/16-1/2-9/16-5/8-11/16-3/4-13/16-7/8 15/16-1,1/16-1,1/8-1,1/4		

1/4"-1,1/4" 16.p	PR-016S	\$154,40
1/4-5/16-3/8-7/16-1/2-9/16-5/8-11/16-3/4-13/16-7/8 15/16-1,1/16-1,1/8-1,1/4		

## CIRCIRLI KOMBİNE ANAHTAR TAKIMI



8-19mm 8.p	GW-7608M	\$95,00
m8-10-11-12-13-14-17-19		

8-19mm 11.p	GW-7611M	\$137,90
m8-10-11-12-13-14-15-16-17-18-19		

5/16"-3/4" 8.p	GW-7708S	\$111,40
5/16-3/8-7/16-1/2-9/16-5/8-11/16-3/4		

## CIRCIRLI KOMBİNE ANAHTAR TAKIMI



8-19mm 7.p	WRGCM7	\$89,00
m8-10-12-13-14-17-19		

## CIRCIRLI KOMBİNE ANAHTAR TAKIMI



8-19mm 8.p	GRP-7608M	\$100,00
m8-10-12-13-14-15-17-19		

8-32mm 17.p	GW-7617M	\$350,00
m8-10-11-12-13-14-15-16-17-18-19-21-22-24-27-30-32		

## MAFSALLI CIRCIRLI KOMBİNE ANAHTAR TAKIMI



8-19mm 8.p	GFP-7608M	\$109,00
m8-10-12-13-14-15-17-19		

## YILDIZ ANAHTAR TAKIMI

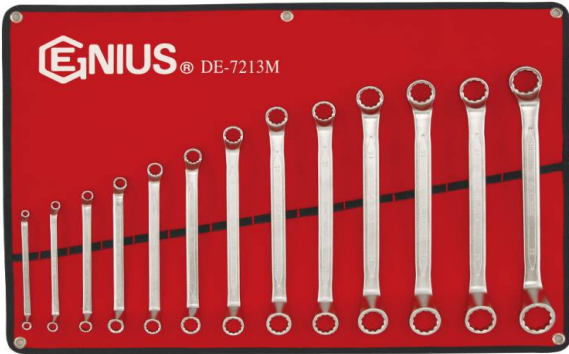

6-22mm MAT 8.p	DE-7208M	\$82,20
m6x7-8x9-10x11-12x13-14x15-16x17-18x19-20x22		

6-32mm MAT 13.p	DE-7213M	\$189,60
m6x7-8x9-10x11-12x13-14x15-16x17-18x19-20x22 21x23-24x26-25x28-27x29-30x32		

6-32mm 13.p	DE-713M	\$242,10
m6x7-8x9-10x11-12x13-14x15-16x17-18x19-20x22 21x23-24x26-25x28-27x29-30x32		

1/4"-1.1/8" 8.p	DE-708S	\$145,70
1/4x5/16-3/8x7/16-1/2x9/16-5/8x11/16-3/4x7/8 7/8x15/16-1x1.1/16-1.1/8x1.1/4		

## İKİ AĞIZLI ANAHTAR TAKIMI



6-22mm 8.p	OW-708M	\$47,40
m6x7-8x9-10x11-12x13-14x15-16x17-18x19-20x22		

6-32mm 13.p	OW-713M	\$97,50
m6x7-8x9-10x11-12x13-14x15-16x17-18x19-20x22 21x23-24x26-25x28-27x30-30x32		

1/4"-1.1/4" 9.p	OW-709S	\$72,90
1/4x5/16-3/8x7/16-1/2x9/16-5/8x11/16-3/4x7/8 13/16x7/8-15/16x1-1x1.1/8-1.1/16x1.1/4		

## UZUN BOY ALLEN ANAHTAR



Ölçü	Boy	
14mm	55x280mm	\$23,00
17mm	63x320mm	\$25,80
19mm	70x360mm	\$30,00

## TORX ANAHTAR TAKIMI



E.6-E.24 4.p	TX-E04	\$40,40
6x8-10x12-14x18-20x24		

## UZUN ALLEN ANAHTAR TAKIMI



1,5-10mm 9.p	HK-009ML	\$27,20
m1,5-2-2,5-3-4-5-6-8-10		

## BOMBE BAŞLI ALTIKÖŞE ALLEN ANAHTAR TAKIMI



1,5-10mm 9.p	HK-009MB	\$23,20
m1,5-2-2,5-3-4-5-6-8-10		

1/16"-3/8" 9.p	HK-009SB	\$23,20
1/16-5/64-3/32-1/8-5/32-3/16-1/4-5/16-3/8		



1,5-10mm 9.p / Kromajlı	HK-09MBS	\$25,60
m1,5-2-2,5-3-4-5-6-8-10		

1/16"-3/8" 9.p / Kromajlı	HK-09SBS	\$25,60
1/16-5/64-3/32-1/8-5/32-3/16-1/4-5/16-3/8		

## TORX TORNAVİDA TAKIMI

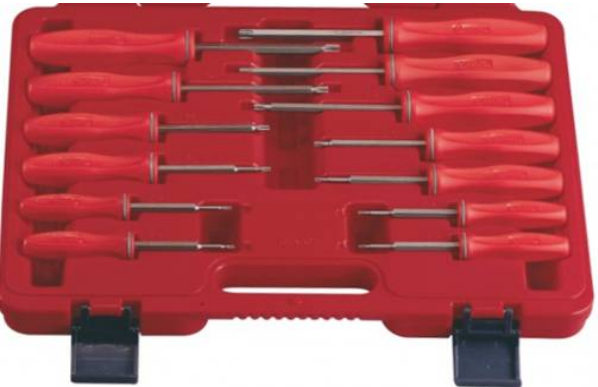

T.6-T.50 13.p	TX-513T	\$55,70
T.6-7-8-9-10-15-20-25-27-30-40-45-50		

## TORX ALLEN ANAHTAR TAKIMI



T.9-T.50 10.p	SK-010S	\$20,90
T.9-10-15-20-25-27-30-40-45-50		

## UZUN TORX ALLEN ANAHTAR TAKIMI



T.9-T.50 10.p	SK-010L	\$23,20
T.9-10-15-20-25-27-30-40-45-50		

## UZUN DELİKLİ TORX ALLEN ANAHTAR TAKIMI



T.9-T.50 10.p	SK-010T	\$25,60
T.9-10-15-20-25-27-30-40-45-50		

## LOKMA TORNAVİDA TAKIMI

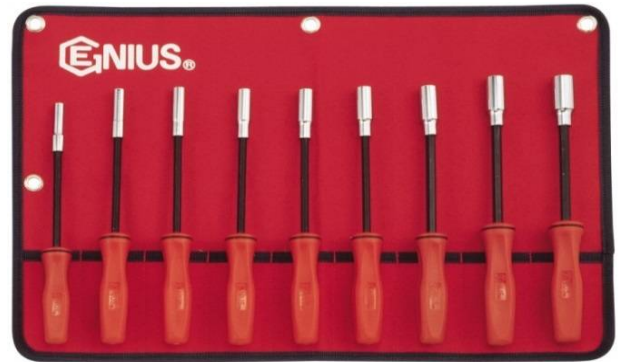

6-14mm 9.p	NM-009MD	\$89,40
m6-7-8-9-10-11-12-13-14		

1/4"-1/2" 6.p	NM-006SD	\$89,40
1/4-5/16-11/32-3/8-7/16-1/2		

# GENIUS

## SAATÇİ TORNAVİDA TAKIMI



6.P	TL-506	\$16,30
-----	--------	---------

Düz:0,4x2-0,4x2,5-0,5x3  
Yıldız:Ph000-00-0

6.P	TL-506A	\$16,30
-----	---------	---------

Düz:0,3x1,2-0,3x1,6-0,4x2  
Yıldız:Ph000-00-0

## BİTS UÇ TAKIMI



1/4"-Arkalı 34.p	SC-234A	\$32,50
---------------------	---------	---------

Allen uç (6)-Düz uç (6)-Yıldız uç (3)-Torx uç (7)  
Delikli torx uç (7)-Kare uç (3)-Uç sapı (1)-Adptör (1)

1/4"-Arkalı 37.p	SC-237M	\$32,50
---------------------	---------	---------

Allen uç (6)-Düz uç (6)-Yıldız uç (6)-Torx uç (7)  
Delikli torx uç (7)-Yıldız allen uç (3)-Uç sapı (1)-Adptör (1)  
Düz:0,3x1,2-0,3x1,6-0,4x2  
Yıldız:Ph000-00-0

## DARBELİ TORNAVİDA TAKIMI



1/2" - 6.P	TG-406B	\$33,70
------------	---------	---------

5/16"Düz uç (2)-5/16"Yıldız uç (2)-Adaptör (1)

## KOMPLE DARBELİ TORNAVİDA TAKIMI



1/2" - 24.P	ID-424S	\$168,60
-------------	---------	----------

1/2"Havalı lokma: 5/16-3/8-7/16-1/2-9/16-5/8-11/16  
3/4-13/16-7/8

1/2"Havalı lokmalı altıköşe allen: 3/16-7/32-1/4-5/16-3/8

1/2"Havalı lokmalı düz uç: 1,6x10-2x12-2,5x14-2,5x16

1/2"Havalı lokmalı yıldız uç: Ph1-2-3-4

## DARBELİ TORNAVİDA



3/8"	700007	\$23,20
------	--------	---------

1/2"	700008	\$23,20
------	--------	---------

## RULMAN ÇEKTİRME TABANI



30 - 50mm	XOR7202	\$37,60
-----------	---------	---------

50 - 75mm	XOR7203	\$58,50
-----------	---------	---------

75 - 105mm	XOR7204	\$91,90
------------	---------	---------

105 - 150mm	XOR7205	\$188,00
-------------	---------	----------

# GENIUS

## İKİ AYAKLI ÇEKTİRME

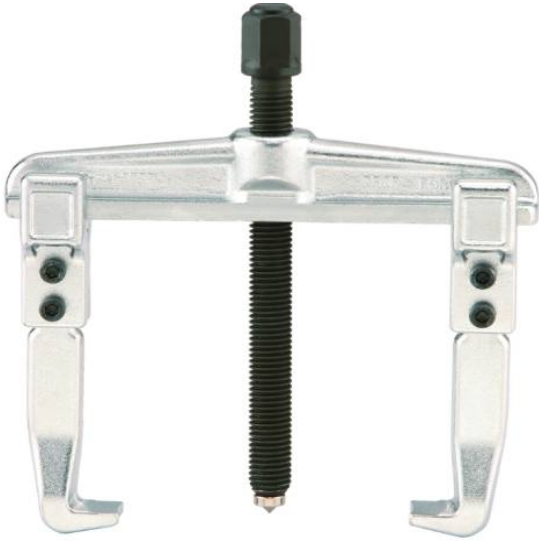

120 x 30-80mm	KA-2080	\$52,70
120 x 30-120mm	KA-2120	\$59,80
160 x 40-160mm	KA-2160	\$94,90
200 x 40-200mm	KA-2200	\$104,40

## İKİ AYAKLI ÇEKTİRME



75 x 75mm	KJ-2076	\$21,60
100 x 100mm	KJ-2102	\$30,90
125 x 125mm	KJ-2127	\$45,30
150 x 150mm	KJ-2152	\$53,30
200 x 200mm	KJ-2203	\$96,60
250 x 250mm	KJ-2254	\$150,20
300 x 300mm	KJ-2305	\$201,80

## ÜÇ AYAKLI ÇEKTİRME



75 x 75mm	KJ-3076	\$32,10
100 x 100mm	KJ-3102	\$42,30
125 x 125mm	KJ-3127	\$56,30
150 x 150mm	KJ-3152	\$68,60
200 x 200mm	KJ-3203	\$148,30
250 x 250mm	KJ-3254	\$229,00
300 x 300mm	KJ-3305	\$311,50

## RULMAN ÇEKTİRME TAKIMI



30 - 70mm

AT-BS12  
(XOR709)

\$162,90

Rulmak çekirme tabanı (2) + Çekirme gövdesi (1)  
Çekirme ayağı 110mm (4) + 125mm (4)

75 - 150mm

XOR709L

\$431,60

Rulmak çekirme tabanı (2) + Çekirme gövdesi (1)  
Çekirme ayağı 120mm (2) + 170mm (2) + 252mm (2)

## HİDROLİK RULMAN ÇEKTİRME TAKIMI



75 - 105mm

XOR706E

\$367,50

Hidrolik mil (1) + Rulmak çekirme tabanı (1)  
Çekirme gövdesi (1) + Çekirme ayağı 250mm (4)

## HİDROLİK İKİ-ÜÇ AYAK VE RULMAN ÇEKTİRME TAKIMI



Rulman  
75 - 105mm  
2-3 Ayak  
100-150-200mm

XOR706C

\$494,20

Hidrolik mil (1) + Rulmak çekirme tabanı (1)  
Rulmak çekirme gövdesi (1)  
Rulman çekirme ayağı 200mm (2)  
2 ayak çekirme gövdesi (1) + 3 ayak çekirme gövdesi (1)  
2-3 ayak çekirme ayağı 100mm (3)  
2-3 ayak çekirme ayağı 150mm (3)  
2-3 ayak çekirme ayağı 200mm (3)

## KAYNAKÇI TİPİ AYARLI PENSE



9" - 225mm

533309LW

\$29,30

## UZUN AĞIZLI TİP AYARLI PENSE

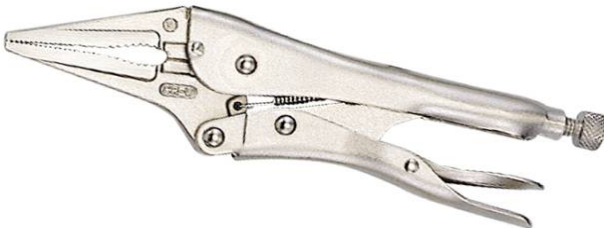

6" - 150mm

531306LN

\$15,40

## AYARLI PENSE



5" - 125mm	530305A	\$16,30
------------	---------	---------

7" - 175mm	530307A	\$20,90
------------	---------	---------

10" - 250mm	530310A	\$20,90
-------------	---------	---------

## KESKİ ZIMBA TAKIMI



14. p	PC-514M	\$48,80
-------	---------	---------

5 Keski-2 Nokta zımba-5 Pim zımba-2 Uzun pim zımba

## TERS KILAVUZ TAKIMI



No:1-6 6. p	AT-EX6	\$10,50
----------------	--------	---------

3-25mm / 1/8"-1"

## AYARLI FİLTRE PENSESİ



10"	53-118mm 2.1/8-4.5/8	AT-OF10A	\$26,50
-----	-------------------------	----------	---------

## BUJİ LOKMALARI



14mm 380mm	4238014T	\$15,10
---------------	----------	---------

16mm (5/8") 380mm	4238016T	\$15,10
----------------------	----------	---------

20,6mm (13/16") 380mm	4238021T	\$17,40
--------------------------	----------	---------



3/8"	16mm (5/8")	326016	\$8,20
------	----------------	--------	--------

3/8"	20,6mm (13/16")	326021	\$8,20
------	--------------------	--------	--------

1/2"	16mm (5/8")	427016	\$9,30
------	----------------	--------	--------

1/2"	20,6mm (13/16")	427021	\$9,30
------	--------------------	--------	--------

## ÜÇ AYAK (AHTAPOT) FİLTRE ANAHTARI



3/8"	65-110mm 2.1/2-4.5/16	AT-B01	\$17,70
------	--------------------------	--------	---------

## FİLLER ÇAKISI (ÇAKI SENTİL)

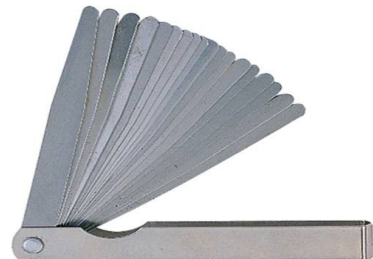

0,05-1,00mm 20 Yaprak	FG-020M	\$9,30
--------------------------	---------	--------

## AMORTİSÖR YAY ÇEKTİRME



300mm  
3/8" Soketli

AT-SC230

\$75,40

## BALANS KURŞUNU ÇEKİCİ (PENSESİ)



250mm

560425

\$22,10

## HORTUM KELEPÇE PENSESİ



220mm

AT-HC10

\$17,40

## FREN DİSK AYAR TAKIMI



AT-08

\$145,00

## SEGMAN ÇEMBERİ



90-175mm  
100mm Boy

PR-1755

\$20,00

90-175mm  
165mm Boy

PR-1757

\$26,00

## ROT BAŞI TAMİR TAKIMI



AT-4808

\$75,40

## SPİRALLİ MIKNATIS



AT-B24

\$15,10

Boy

600mm / 24"

Kapasite

1,60 Kg

## TORKLU UZATMA TAKIMI



90-200nm  
65-150ft.lb

TO-410EXT

\$226,20

## TELESKOPİK MIKNATIS



AT-B16

\$11,60

Boy

645mm / 25,1/2"

Kapasite

1,60 Kg

## MANYETİK STAND



305mm / 12"	005012	\$18,60
-------------	--------	---------

405mm / 16"	005016	\$22,00
-------------	--------	---------

## LOKMA ANAHTAR STANDI



1/4" - 410mm 15 Klips	010152	\$8,20
--------------------------	--------	--------

3/8" - 480mm 15 Klips	010153	\$8,20
--------------------------	--------	--------

1/2" - 560mm 15 Klips	010154	\$9,30
--------------------------	--------	--------

## İZOLELİ PENSE



7" - 175mm	551712S	\$22,60
------------	---------	---------

7" - 175mm	551712D	\$22,60
------------	---------	---------

## TOPUKLU KEÇE LEVYESİ



561116	\$14,00
--------	---------

Boy	405mm
-----	-------

## İZOLELİ YANKESKİ



6" - 150mm	550607D	\$21,60
------------	---------	---------

## SAPLAMA SÖKME VE TAKIMI



6-12mm 4.p	FD-404M	\$47,60
---------------	---------	---------

m6-8-10-12

1/2"-8mm	426308	\$12,00
----------	--------	---------

1/2"-10mm	427410	\$12,00
-----------	--------	---------

## İZOLELİ KARGABURUN



6" - 150mm	550604S	\$17,10
------------	---------	---------

6" - 150mm	550604D	\$17,10
------------	---------	---------

8" - 200mm	550804D	\$19,50
------------	---------	---------

## MEKANİK (EL) GRES POMPASI

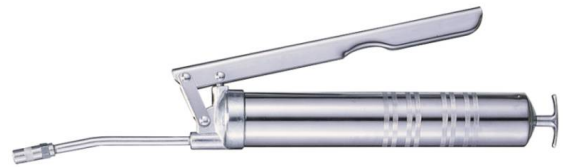

500cc	AT-46012	\$27,90
-------	----------	---------

## İZOLELİ FORT PENSE



10" - 250mm	551011D	\$27,40
-------------	---------	---------

## SAC MAKASI



10" - 250mm Sağ	511002R	\$19,80
--------------------	---------	---------

## DÜZ İÇ SEGMAN PENSESİ

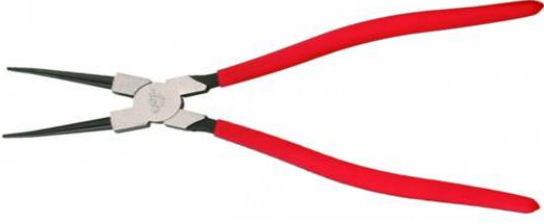

7" - 175mm

550751

\$22,10

## EĞRİ İÇ SEGMAN PENSESİ



7" - 175mm

550753

\$22,10

## DÜZ DIŞ SEGMAN PENSESİ



7" - 175mm

550750

\$22,10

## EĞRİ DIŞ SEGMAN PENSESİ



7" - 175mm

550752

\$22,10

## ELMAS EĞE TAKIMI



FL-0785

\$32,50

200mm 5 Parçalı

## POP PERÇİN PENSESİ



SC-715

\$31,40

2,4 - 3,2 - 4 - 4,8mm

## KOLLU POP PERÇİN PENSESİ



SC-714

\$51,10

3,2 - 4 - 4,8 - 6,4mm

## SOMUNLU PERÇİN PENSESİ



SC-758A

\$66,20

3 - 4 - 5 - 6mm

## KOLLU SOMUNLU PERÇİN PENSESİ



SC-785M

\$192,60

5 - 6 - 8 - 10mm

# GENIUS

## KURBAĞACIK



4" - 100mm	780128	\$15,10
6" - 150mm	780192	\$15,10
8" - 200mm	780256	\$16,80
10" - 250mm	780320	\$22,30
12" - 300mm	780384	\$29,30
15" - 380mm	780480	\$59,40
18" - 450mm	780576	\$105,40
24" - 600mm	780692	\$219,30

## BORU ANAHTARI



12" - 300mm	782300	\$38,30
14" - 350mm	782350	\$46,20
18" - 460mm	782460	\$65,10
24" - 600mm	782610	\$99,20
36" - 900mm	782910	\$153,60
48" - 1200mm	783220	\$344,80

## KOMPLE ÇANTALI EL ALETİ TAKIMI



125.p	AC-234125	\$306,30
1/4" Altıköşe kısa lokma: m4-4,5-5-5,5-6-7-8-9-10-11-12-13		
3/8" Altıköşe kısa lokma: m6-7-8-9-10-11-12-13-14-15-16-17-18-19		
1/2" Altıköşe kısa lokma: m11-12-13-14-15-16-17-18-19-20-21-22-23-24-25-26-27		
1/4" Bits uçlar: Düz (4)-Yıldız (8)-Allen (6)-Torx (7)-Robertson (3)		
Circir kol: 3/8 (1)-1/2 (1) Uzatma: 1/4 (1)-3/8 (2)-1/2 (2)		
1/4" Lokma sapı-1/4" Uç sapı-1/4" Manyetik adp. Buji lokması: 1/2 (2)		
1/4" Uç adp.-Pense-Yankeski-Kargaburun		
Allen anahtar: m1,5-2-2,5-3-4-5-6-8-10		
Kombine anahtar: m6-7-8-9-10-11-12-13-14-15-16-17-19		

## KOMPLE ÇANTALI EL ALETİ TAKIMI



151.p	AC-234151	\$506,70
1/4" Altıköşe kısa lokma: m4-5-5,5-6-7-8-9-10-11-12		
1/8-3/16-7/32-1/4-9/32-5/16-11/32		
1/4" Kısa dişli torx lokma: E.4-5-6-7-8-10		
1/4" Kısa kare lokma: m8-10		
3/8" Altıköşe kısa lokma: m13-14-15-16-17-18-19		
3/8" Altıköşe uzun lokma: m8-9-10-12-13-14-15-16-17-18-19		
3/8" Yıldız kısa lokma: 3/8-7/16-1/2-9/16-5/8-11/16-3/4-13/16-7/8		
3/8" Kısa dişli torx lokma: E.12-14-16-18-20		
1/2" Altıköşe kısa lokma: m20-21-22-24-27-30-32		
1/2" Yıldız kısa lokma: 15/16-1-1,1/16-1,1/4		
1/2" Altıköşe kısa havalı lokma: m17-18-19-21-22		
1/4" Bits uçlar: Düz (4)-Yıldız (8)-Allen (6)-Torx (7)-D.torx (11)		
Circir kol: 1/4 (1)-3/8 (1)-1/2 (1) Ara mafsal: 1/4 (1)-3/8 (1)-1/2 (1)		
Uzatma: 1/4 (1)-3/8 (2)-1/2 (2) Buji lokması: 3/8 (2)		
1/4" Lokma sapı-1/4" Uç sapı-1/4" Manyetik adp.		
1/4" Uç adp.-Pense-Yankeski-Kargaburun		
Allen anahtar: m1,5-2-2,5-3-4-5-6-8-10		
Kombine anahtar: m8-9-10-11-12-13-14-15-16-17-18-19		

# GENIUS

## KOMPLE ÇANTALI EL ALETİ TAKIMI



161 .p

AC-234161R

\$522,00

1/4" Altıköşe kısa lokma:m4-4,5-5-5,5-6-7-8-9-10-11-12  
 1/8-3/16-7/32-1/4-9/32-5/16-11/32  
 1/4"Kısa dişi torx lokma:E.4-5-6-7-8-10  
 1/4" Altıköşe uzun lokma:m8-9-10-12-13-14  
 3/8" Altıköşe kısa lokma:m13-14-15-16-17-18-19  
 3/8"Yıldız kısa lokma:3/8-7/16-1/2-9/16-5/8-11/16-3/4-13/16-7/8  
 3/8"Kısa dişi torx lokma: E.12-14-16-18-20  
 1/2" Altıköşe kısa lokma: m20-21-22-24-27-30-32  
 1/2"Yıldız kısa lokma: 15/16-1-1,1/16-1,1/4  
 1/2" Altıköşe uzun havalı lokma:m17-19-21  
 Cırcır kol:1/4 (1)-3/8 (1)-1/2 (1) Ara mafsalsı:1/4 (1)-3/8 (1)-1/2 (1)  
 Uzatma:1/4 (2)-3/8 (1)-1/2 (2) Buji lokması: 3/8 (3)  
 1/4"Lokma sapı-1/4" Torn.için lokma adp. (3)-Uç sapı-1/4"Manyetik adp.  
 1/4"Lokma sapı-Pense-Yankeski-Kargaburun  
 1/4" S.Sıkma için uç adp.-1/4" Torn.için lokma adp. (3)-1/4"Manyetik adp.  
 1/4"Bits uçlar:Düz (6)-Yıldız (8)-Allen (8)-Torx (11)-D.torx (14)-Fare dş  
 Allen anahtar: m1,5-2-2,5-3-4-5-6-8-10  
 Kombine anahtar: m8-9-10-11-12-13-14-15-16-17-18-19

## ÇEKMECELİ TAKIM DOLABI



TS-790

\$665,10

10 Çekmeceli - Boş  
 660x455x483mm

## ÇEKMECELİ TAKIM ARABASI



TS-798

\$986,00

7 Çekmeceli - Boş  
 670x460x813mm

TS-798/198P

\$2.380,40

7 Çekmeceli -Dolu: 198 parça  
 670x460x813mm  
 MS-437M 37 P.Lokma seti  
 MS-007P 7 P.Pense seti  
 MS-008R 8 P.Filtre ve Segman pense seti  
 MS-019 19 P.Çekiç ve Keski seti  
 MS-020M 20 P.Kombine Anahtar seti  
 MS-020B 20 P.Açıkığız,Torx Yıldız an. seti  
 MS-086 86 P.Tornavida,Bitsuç ve Allen an.

## ÇEKMECELİ TAKIM ARABASI VE DOLABI MUHTEVİYATLARI



20 P. Açıkağız, Torx, Yıldız anahtar seti  
Açıkağız: 6x7-8x9-10x11-12x13-14x15  
16x17-18x19-20x22  
Yıldız: 6x7-8x9-10x11-12x13-14x15  
16x17-18x19-20x22  
Torx: 6x8-10x12-14x18-20x24

**MS-020B**

**\$203,00**



20 P. Kombine Anahtar seti  
Kombine: m6-7-8-9-10-11-12-13-14-15  
16-17-18-19-21-22-24-27-30-32

**MS-020M**

**\$203,00**



23 P. Lokma seti  
1/2" Yıldız Lokma: 8-10-11-12-13-14-15  
16-17-18-19-21-22-23-24-27-30-32  
Uzatma (2)-Mafsal-T kol-Circir

**TW-423M**

**\$141,60**



37 P. Lokma seti  
1/2" Altıköşe Lok.: 8-9-10-11-12-13-14  
15-16-17-18-19-21-22-24-27-30-32-36  
1/2" Torx Lokma: 10-11-12-14-16-18-20  
22-24  
1/2" Buji Lokması: 16-20,6  
Uzatma (3)-Mafsal-Adaptör  
Mafsal kol-Circir

**MS-437M**

**\$261,00**



7 P. Pense seti  
Pense 180mm-Yankeski 180mm  
Düz kargaburun 200mm  
Eğri kargaburun 200mm  
Ayarlı pense 250mm-Fort pense 250mm  
Uzun burunlu ayarlı pense 150mm

**MS-007P**

**\$154,30**



8 P. Filtre ve Segman pense seti

**MS-008R**

**\$153,20**

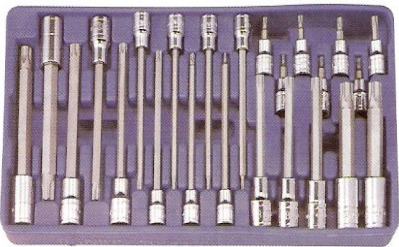

24 P. Lokmalı Torx allen seti  
3/8" Lok.torx: T.10-15-20-25-27-30  
40 (50mm)  
3/8" Lok.torx: T.10-15-20-25-27-30  
40 (140mm)  
1/2" Lok.torx: T.45-50-55-60-70 (80mm)  
1/2" Lok.torx: T.45-50-55-60-70 (150mm)

**BS-3424T**

**\$127,60**



19 P. Çekiç ve Keski seti  
Keski: 6x125-10x140-14x150-19x200  
25x200  
Nokta zımba: 3x60-5x70-6x75-8x80  
9x85  
Pim zımba: 2x100-3x125-4x140-5x60  
6x200  
8x200 - Çekiç (2)

**MS-019**

**\$191,40**



4 P. Pense seti  
Pense 180mm-Kargaburun 150mm  
Yankeski 150mm-Fort pense 250mm

**CP-5804**

**\$89,40**

## ÇEKMECELİ TAKIM ARABASI VE DOLABI MUHTEVİYATLARI

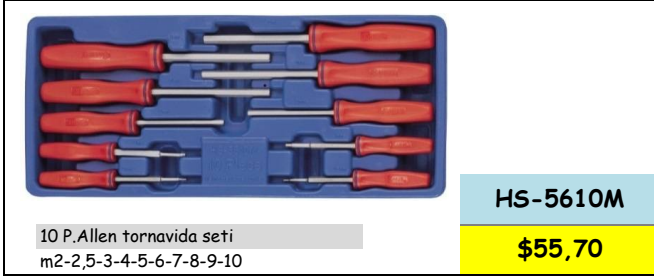

10 P.Allen tornavida seti  
m2-2,5-3-4-5-6-7-8-9-10

HS-5610M

\$55,70

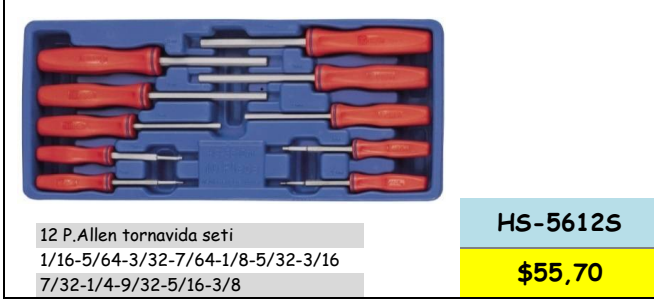

12 P.Allen tornavida seti  
1/16-5/64-3/32-7/64-1/8-5/32-3/16  
7/32-1/4-9/32-5/16-3/8

HS-5612S

\$55,70



8 P.Bombe Başlı Allen tornavida seti  
m3-4-5-6-7-8-9-10

HS-5708MW

\$52,20

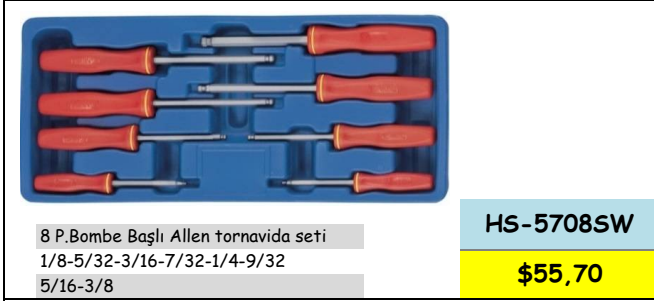

8 P.Bombe Başlı Allen tornavida seti  
1/8-5/32-3/16-7/32-1/4-9/32  
5/16-3/8

HS-5708SW

\$55,70

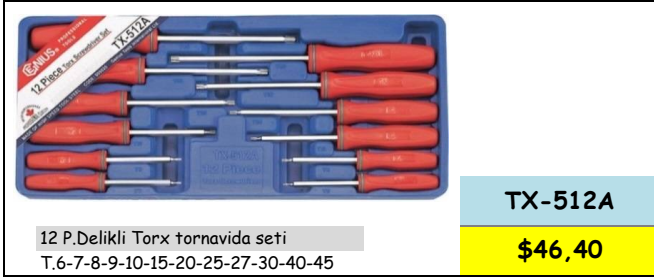

12 P.Delikli Torx tornavida seti  
T.6-7-8-9-10-15-20-25-27-30-40-45

TX-512A

\$46,40

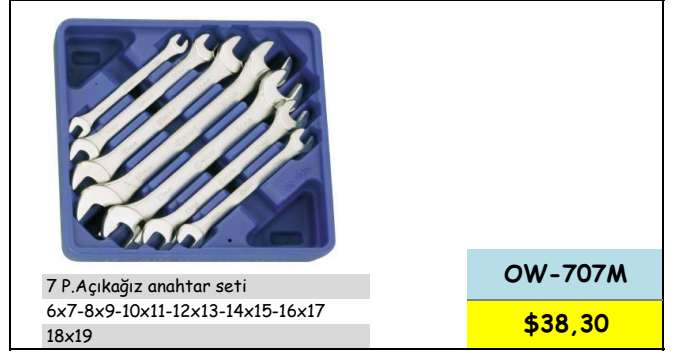

7 P.Açıkbaş anahtar seti  
6x7-8x9-10x11-12x13-14x15-16x17  
18x19

OW-707M

\$38,30

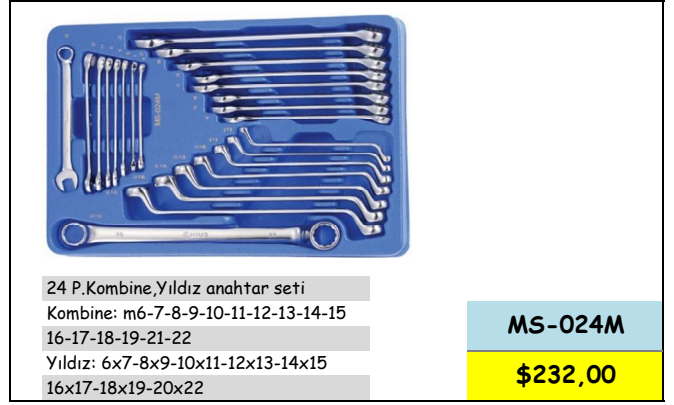

24 P.Kombine,Yıldız anahtar seti  
Kombine: m6-7-8-9-10-11-12-13-14-15  
16-17-18-19-21-22  
Yıldız: 6x7-8x9-10x11-12x13-14x15  
16x17-18x19-20x22

MS-024M

\$232,00

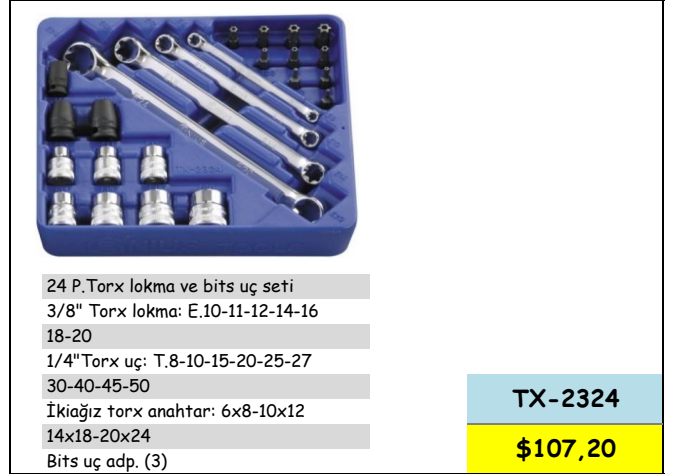

24 P.Torx lokma ve bits uç seti  
3/8" Torx lokma: E.10-11-12-14-16  
18-20  
1/4" Torx uç: T.8-10-15-20-25-27  
30-40-45-50  
İkibağ torx anahtar: 6x8-10x12  
14x18-20x24  
Bits uç adp. (3)

TX-2324

\$107,20

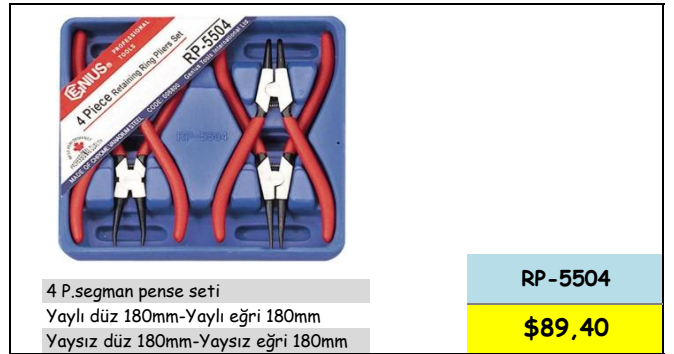

4 P.segman pense seti  
Yaylı düz 180mm-Yaylı eğri 180mm  
Yaysız düz 180mm-Yaysız eğri 180mm

RP-5504

\$89,40

86 P.Tornavida,Bits uç ve Allen an.  
Düz torn.(4)-Delikli torx torn.(10)  
Yıldız torn.(Ph 2-Pz 2)-Flex bits tut.  
Bits uç (44)-Manyetik bits tutucu  
Bits uç sapı (3)-B.Baş allen an.takımı  
Delikli torx allen an.takımı

MS-086

\$228,60

# GENIUS

## ÇEKMECELİ TAKIM ARABASI VE DOLABI MUHTEVİYATLARI



35 P.Pense,Kurbağacık,Allen,Çekiç ve  
Torn.seti-Düz torn.(5)-Yıldız torn.(5)  
Pense 175mm-Yankeski 150mm  
Düz k.burun150mm-Fort prnse 250mm  
B.Baş allen an.takımı (2)  
Kurbağacık 200mm-Ayarlı pense 175mm  
Çekiç

MS-035MS

\$220,40

## CIRCIRLI TORK ANAHTARI



Soket 1"  
Kapasitesi 300-1500nm  
Boyu 1700mm

881500N

\$1.390,00

Soket 1"  
Kapasitesi 400-2000nm  
Boyu 2175mm

882000N

\$1.845,00

Soket 1/4"  
Kapasitesi 6-30nm  
Boyu 350mm

280030N

\$90,50

Soket 3/8"  
Kapasitesi 6-30nm  
Boyu 350mm

380030N

\$90,50

Soket 3/8"  
Kapasitesi 19-110nm  
Boyu 385mm

380110N

\$98,60

Soket 1/2"  
Kapasitesi 40-210nm  
Boyu 535mm

480210N

\$110,20

Soket 1/2"  
Kapasitesi 70-350nm  
Boyu 645mm

480350N

\$146,20

Soket 3/4"  
Kapasitesi 100-500nm  
Boyu 865mm

680500N

\$320,00

Soket 3/4"  
Kapasitesi 140-700nm  
Boyu 1092mm

680700N

\$603,20

Soket 3/4"  
Kapasitesi 140-980nm  
Boyu 1230mm

680980N

\$751,70

Soket 1"  
Kapasitesi 140-980nm  
Boyu 1230mm

880980N

\$777,20

## CIRCIRLI TORK ANAHTARI (ÇİFT YÖNLÜ)



Soket 1/4"  
Kapasitesi 3-15nm  
Boyu 193mm

290015N

\$90,50

Soket 3/8"  
Kapasitesi 10-60nm  
Boyu 427mm

390060N

\$115,00

Soket 1/2"  
Kapasitesi 20-100nm  
Boyu 462mm

490100N

\$125,00

Soket 3/4"  
Kapasitesi 200-1000nm  
Boyu 1335mm

691000N

\$827,00

Soket 1"  
Kapasitesi 300-1500nm  
Boyu 1702mm

891500N

\$1.390,00

Soket 1"  
Kapasitesi 400-2000nm  
Boyu 2150mm

892000N

\$1.845,00

Soket 1 1/2"  
Kapasitesi 600-3000nm  
Boyu 2780mm

993000N

\$2.192,40

## DİJİTAL CIRCIRLI TORK ANAHTARI



Soket 3/8"  
Kapasitesi 20-200nm  
Boyu 575mm

V38200

\$210,00

## DEĞİŞTİRİLEBİLEN KAFALI TORK ANAHTAR TAKIMI



Kafa	9x12mm
Kapasitesi	19-110nm
3/8" Geçmeli Cırcır kafası (1)	
Geçmeli Açık ağız anahtar ağızı (11)	
m.10,11,12,13,14,15,16,17,18,19	

**TO-312N11**

**\$191,40**

Kafa	14x18mm
Kapasitesi	40-210nm
1/2" Geçmeli Cırcır kafası (1)	
Geçmeli Açık ağız anahtar ağızı (9)	
m.13,14,15,17,19,22,24,27,30	

**TO-411N21**

**\$220,40**

## TORNAVİDA TİPİ TORK ANAHTARI



Soket	1/4"
Kapasitesi	9-50in.lbs
Boyu	150mm

**280045L**

**\$127,60**

Soket	1/4"
Kapasitesi	1-5nm
Boyu	150mm

**280005N**

**\$127,60**



Soket	1/4"
Kapasitesi	1-5nm
Boyu	150mm

Tornavida tipi tork anahtarı: 280005N

30mmDüz torn. ucu: m1x6-1x6,5-1,2x7

30mmYıldız tornavida ucu: Ph1-2-3

30mmAllen tornavida ucu: m3-4-5-6

1/8-5/32-3/16-7/32-1/4

30mmDelikli torx uc: T.10-15-20-25-27

30-40

30mmYıldız (fare diş) torn. ucu: m4-5-6

Bits uç adaptörü:1/4-1/4

**TO-227N**

**\$150,80**

## DEĞİŞTİRİLEBİLEN KAFALI DİJİTAL TORK ANAHTAR TAKIMI



Kafa	14x18mm
Kapasitesi	10-100nm
3/8"-1/2" Geçmeli Cırcır kafası (2)	

**1434N10**

**\$336,00**

Kafa	14x18mm
Kapasitesi	20-200nm
3/8"-1/2" Geçmeli Cırcır kafası (2)	

**1434N20**

**\$362,00**

## TORK YÜKSELTİCİ



Giriş	3/4"-Max:900nm
Çıkış	1"-Max:2700nm
Tur sayısı	3/1
Boy/mm	500mm
Ağırlığı	4,75 Kg

**602000**

**\$510,40**



Giriş	1/2"-Max:215nm
Çıkış	1"-Max:2700nm
Tur sayısı	12/1
Ağırlığı	9,80 Kg

**482000**

**\$767,30**



Giriş	1/2"-Max:400nm
Çıkış	1"-Max:4000nm
Tur sayısı	10/1
Boy/mm	260mm
Ağırlığı	18,50 Kg

**494008B**

**\$1.038,20**

# GENIUS

## "T" KOLLAR



1/4"	150mm	280020	\$4,50
3/8"	250mm	380030	\$7,40
1/2"	320mm	480040	\$11,90
3/4"	500mm	680060	\$26,70
1"	630mm	880063	\$93,40
1.1/2"	915mm	980090	\$169,50

## "L" KOLLAR



1/2"	260mm	420260L	\$11,90
3/4"	330mm	620330L	\$20,10
3/4"	400mm	620400L	\$26,70

## CIRCIR KOLLARI



1/4"	Çevirmeli	280272	\$14,50
1/4"	Mandallı	280222R	\$19,00
3/8"	Çevirmeli	383372	\$20,30
3/8"	Mandallı	380333R	\$24,80
3/8"	Mandallı-Mafsal.	383363	\$53,80
1/2"	Çevirmeli	480472	\$21,90
1/2"	Mandallı	480444R	\$26,10
1/2"	Mandallı-Göbek	480444H	\$28,00
3/4"	çıkmalı Mandallı	680666R	\$72,50
1"	Mandallı	880888R	\$97,30

## MAFSALLI KOLLAR



3/8"	200mm	380336A	\$15,10
1/2"	380mm	480446A	\$26,70
3/4"	560mm	680446E	\$95,20
1"	815mm	880846E	\$130,80

## FIRDÖNDÜ KOLLAR



3/8"	400mm	380400	\$12,70
1/2"	420mm	480420	\$20,90

## LOKMA SAPI



1/4"	140mm	220150	\$4,90
------	-------	--------	--------

## HAVALI LOKMA ADAPTÖRLERİ



1/4-3/8	25mm	290030	\$3,50
3/8-1/4	30mm	380020	\$3,50
3/8-1/2	35mm	380040	\$4,30
1/2-3/8	38mm	480033MB	\$5,10
1/2-3/4	41mm	40066MB	\$9,50
3/4-1/2	63mm	640604B	\$17,50
3/4-1"	65mm	640608B	\$17,40
1"-3/4	70mm	841006B	\$21,90
1"-1.1/2	80mm	841012B	\$42,00
1.1/2-1"	98mm	938008	\$124,80
1.1/2-2.1/2	80mm	938020	\$525,50
2.1/2-1.1/2	98mm	920012	\$1.576,00

## KROMAJLI LOKMA ADAPTÖRLERİ



1/4-3/8	25mm	280030	\$4,00
3/8-1/2	35mm	320040	\$5,50
1/2-3/8	38mm	420033	\$6,50
3/4-1/2	63mm	620604	\$15,40
3/4-1"	65mm	620608	\$18,40
1"-3/4	70mm	821006	\$18,40

## ADAPTÖR YEDEK KARELERİ



1/2"	\$6,20
3/4"	\$13,40
1"	\$40,10

# GENIUS

## HAVALI MAFSALLAR (SARHOŞ)



1/4"	40mm	700106	\$14,00
3/8"	65mm	700107	\$14,00
1/2"	70mm	700108	\$15,80
3/4"	110mm	640606B	\$46,40
1"	130mm	840808B	\$105,00

## KROMAJLI MAFSALLAR (SARHOŞ)



1/4"	40mm	280070	\$7,80
3/8"	54mm	380070	\$12,20
1/2"	78mm	480070	\$15,40
3/4"	110mm	680606	\$45,80
1"	130mm	880808	\$53,40

## HAVALI LOKMA UZATMALARI



3/8"	75mm	340075B	\$5,80
3/8"	125mm	340125B	\$7,60
3/8"	150mm	380036	\$8,20
3/8"	200mm	340200B	\$13,40
1/2"	50mm	480030MB	\$14,00
1/2"	75mm	480032MB	\$6,80
1/2"	125mm	480036MB	\$7,50
1/2"	150mm	480150MB	\$8,30
1/2"	200mm	410008	\$9,90
1/2"	250mm	480250MB	\$26,70
3/4"	100mm	640100B	\$21,20
3/4"	150mm	640150B	\$25,40
3/4"	200mm	640200B	\$29,50
3/4"	250mm	640250B	\$34,20
1"	150mm	840150B	\$39,00
1"	200mm	841064B	\$52,30
1"	250mm	840250B	\$62,50
1"	400mm	840400B	\$124,80
1.1/2"	175mm	938175	\$727,10
1.1/2"	250mm	938250	\$862,70

## KROMAJLI LOKMA UZATMALARI



1/4"	100mm	220004	\$6,80
1/4"	150mm	220006	\$6,80
3/8"	75mm	320075	\$7,70
3/8"	125mm	320125	\$8,00
3/8"	150mm	320150	\$8,00
3/8"	200mm	320200	\$8,20
3/8"	250mm	320250	\$9,00
1/2"	75mm	424075	\$7,70
1/2"	125mm	424125	\$7,70
1/2"	250mm	424320	\$10,10
1/2"	200mm	424200	\$10,10
1/2"	300mm		\$10,10
3/4"	100mm	620100	\$16,80
3/4"	150mm	620150	\$16,80
3/4"	200mm	620200	\$16,80
3/4"	250mm	620250	\$16,80
3/4"	400mm	620400	\$30,10
1"	150mm	820150	\$31,00
1"	200mm	820200	\$31,00
1"	250mm	820250	\$31,00
1"	400mm	820400	\$75,20

## BOMBE BAŞLI KROMAJLI LOKMA UZATMALARI



1/2"	75mm	420003B	\$8,70
1/2"	125mm	420005B	\$11,90
1/2"	200mm	420008B	\$14,60
1/2"	250mm	420010B	\$16,30

## HAVALI LOKMALI DÜZ TORNAVİDA UÇLARI



3/8"							
1x5,5	52mm	3452P055	\$7,10				
1,2x8	52mm	3452P08	\$7,10				
1,6x10	52mm	3452P10	\$7,10				
				1/2"			
				1,6x10	60mm	4460P10	\$7,10
				2x12	60mm	4460P12	\$7,10
				2,5x14	60mm	4460P14	\$7,10
				2,5x16	60mm	4460P16	\$7,10

# GENIUS

## HAVALI LOKMALI YILDIZ TORNAVIDA UÇLARI



3/8"

Ph1	52mm	3452R01	\$7,10
Ph2	52mm	3452R02	\$7,10
Ph3	52mm	3452R03	\$7,10
Ph4	52mm	3452R04	\$7,10

1/2"

Ph1	60mm	4460R01	\$7,10
Ph2	60mm	4460R02	\$7,10
Ph3	60mm	4460R03	\$7,10
Ph4	60mm	4460R04	\$7,10

## HAVALI LOKMALI ALTIKÖŞE ALLENLER



3/8"

4mm	52mm	345204	\$6,30
5mm	52mm	345205	\$6,30
6mm	52mm	345206	\$6,30
7mm	52mm	345207	\$6,30
8mm	52mm	345208	\$6,30
10mm	52mm	345210	\$6,30
12mm	52mm	345212	\$6,30
5/32	52mm	365205	\$7,30
3/16	52mm	365206	\$7,30
7/32	52mm	365207	\$7,30
1/4	52mm	365208	\$7,30
5/16	52mm	265210	\$7,30
3/8	52mm	365212	\$7,30
7/16	52mm	365214	\$9,00
1/2	52mm	365216	\$9,00
9/16	52mm	365218	\$9,30
5/8	52mm	365220	\$9,50

1/2"

4mm	60mm	446004	\$7,00
5mm	60mm	446005	\$7,00
6mm	60mm	446006	\$7,00
7mm	60mm	446007	\$7,80
8mm	60mm	446008	\$7,80
9mm	60mm	446009	\$7,80
10mm	60mm	446010	\$7,80
12mm	60mm	446012	\$7,80
14mm	60mm	446014	\$8,00
14mm	76mm	446014	\$11,50
16mm	60mm	446016	\$8,50
17mm	60mm	446017	\$8,50
19mm	60mm	446019	\$9,70
5/32	60mm	466005	\$7,90
3/16	60mm	466006	\$7,90
7/32	60mm	466007	\$8,40
1/4	60mm	466008	\$8,40
5/16	60mm	466010	\$8,40
3/8	60mm	466012	\$8,40
7/16	60mm	466014	\$8,40
1/2	60mm	466016	\$8,40
9/16	60mm	466018	\$9,30
5/8	60mm	466020	\$12,00
11/16	60mm	466022	\$12,00
3/4	60mm	466024	\$12,00

3/4"

14mm	80mm	619+2914	\$26,30
17mm	80mm	619+2917	\$26,30
19mm	88mm	619+2919	\$26,30
21mm	88mm	648821	\$26,30
22mm	88mm	622+2922	\$26,30
24mm	88mm	622+2924	\$28,00
27mm	88mm	627+2927	\$28,00
30mm	88mm	627+2930	\$28,00
32mm	88mm	627+2932	\$30,70

1"

17mm	85mm	819+2917	\$30,70
19mm	98mm	819+2919	\$30,70
21mm	98mm	849821	\$30,70
22mm	98mm	822+2922	\$30,70
24mm	98mm	822+2924	\$32,40
27mm	98mm	827+2927	\$32,40
30mm	98mm	827+2930	\$35,00
32mm	98mm	827+2932	\$35,00
33mm	98mm	832+2933	\$36,80
36mm	98mm	832+2936	\$36,80

1.1/2"

36mm	110mm	941+3036	\$300,00
41mm	115mm	941+3041	\$310,00
46mm	115mm	941+3046	\$320,00

## HAVALI LOKMALI TORX ALLENLER



1/2"

T.10	60mm	4460S10	\$8,20
T.15	60mm	4460S15	\$8,20
T.20	60mm	4460S20	\$8,20
T.25	60mm	4460S25	\$8,20
T.27	60mm	4460S27	\$8,20
T.30	60mm	4460S30	\$8,20
T.40	60mm	4460S40	\$8,20
T.45	60mm	4460S45	\$9,00
T.50	60mm	4460S50	\$9,00
T.55	60mm	4460S55	\$9,00
T.60	60mm	4460S60	\$9,00
T.70	60mm	4460S70	\$9,70

# GENIUS

## KROMAJLI UZUN BOMBE BAŞLI LOKMALI ALTİKÖŞE ALLENLER

1/2"

6mm	230mm	408+4836	\$10,30
8mm	230mm	410+4848	\$10,30



## KROMAJLI KISA LOKMALI ALTİKÖŞE ALLENLER

1/4"



2mm	26mm	232802	\$4,30
2,5mm	26mm	208+2125	\$4,30
3mm	26mm	232803	\$4,30
4mm	26mm	232804	\$4,30
5mm	26mm	232805	\$4,30
6mm	26mm	232806	\$4,30
7mm	26mm	232807	\$4,30
8mm	26mm	232808	\$4,30
9mm	26mm	232809	\$4,30
10mm	26mm	232810	\$4,30
1/16	45mm	208+3104	\$6,40
5/64	45mm	208+3105	\$6,40
3/32	45mm	208+3106	\$6,40
7/64	45mm	208+3107	\$6,40
1/8	45mm	208+3108	\$6,40
5/32	45mm	208+3110	\$6,40
3/16	45mm	208+3112	\$6,40
7/32	45mm	208+3114	\$6,40
1/4	26mm	272808	\$6,40
9/32	26mm	272809	\$6,40
5/16	26mm	272810	\$6,40
3/8	26mm	272812	\$6,40

3/8"

3mm	50mm	308+2133	\$4,80
4mm	50mm	308+2134	\$4,80
5mm	50mm	308+2135	\$4,80
6mm	50mm	308+2136	\$4,80
7mm	50mm	310+2147	\$5,80
8mm	50mm	310+2148	\$5,80
9mm	50mm	339+2149	\$6,40
10mm	50mm	340+2150	\$6,40
9/32	50mm	310+3128	\$7,70
5/16	50mm	310+3130	\$7,70
3/8	50mm	312+3134	\$7,70
7/16	50mm	314+3138	\$7,70
1/2	50mm	316+3142	\$7,70

1/2"

4mm	55mm	408+2134	\$4,80
5mm	55mm	408+2135	\$4,80
6mm	55mm	408+2136	\$4,80
7mm	55mm	410+2147	\$5,80
8mm	55mm	410+2148	\$5,80
9mm	55mm	439+2149	\$6,40
10mm	55mm	440+2150	\$6,40
12mm	55mm	442+2152	\$7,10
3/16	55mm	408+3112	\$7,90
7/32	55mm	408+3114	\$8,40
1/4	55mm	408+3116	\$8,40
5/16	55mm	410+3130	\$8,40
3/8	55mm	412+3134	\$8,40
7/16	55mm	414+3138	\$8,40
1/2	55mm	416+3142	\$8,40

## KROMAJLI UZUN LOKMALI ALTİKÖŞE ALLENLER

1/4"

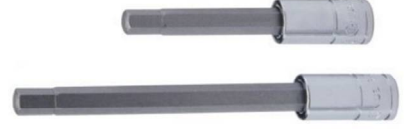

1/16	100mm	208+3504	\$11,00
5/64	100mm	208+3505	\$11,00
3/32	100mm	208+3506	\$11,00
7/64	100mm	208+3507	\$11,00
1/8	100mm	208+3508	\$11,00
5/32	100mm	208+3510	\$11,00
3/16	100mm	208+3512	\$11,00
7/32	100mm	208+3514	\$11,00
1/4	100mm	208+3516	\$11,00

3/8"

9/32	110mm	310+3518	\$11,00
5/16	110mm	310+3520	\$11,00
3/8	110mm	312+3524	\$11,00
7/16	110mm	314+3528	\$11,00
1/2	110mm	316+3532	\$11,00

1/2"

4mm	110mm	408+2534	\$6,70
5mm	110mm	408+2535	\$6,70
6mm	110mm	408+2536	\$6,70
8mm	110mm	410+2548	\$7,40
10mm	110mm	440+2550	\$7,70
10mm	150mm	440+2650	\$15,00
11mm	80mm	441+2351	\$11,00
12mm	80mm	442+2352	\$11,00
12mm	110mm	442+2552	\$12,00
14mm	80mm	444+2354	\$9,40
17mm	80mm	447+2357	\$10,10
17mm	150mm	447+2657	\$15,70
19mm	80mm	449+2359	\$13,00
19mm	150mm	449+2659	\$17,40
1/4	110mm	408+3516	\$7,90
5/16	110mm	410+3520	\$9,50
7/16	110mm	414+3528	\$10,00
1/2	110mm	416+3532	\$10,00
9/16	80mm	418+3336	\$10,00
9/16	110mm	418+3536	\$11,00
5/8	80mm	420+3340	\$11,50
5/8	110mm	420+3540	\$13,00
3/4	80mm	424+3348	\$15,00

## KROMAJLI KISA LOKMALI TORX ALLENLER

1/2"



T-20	55mm	408+6120	\$5,80
T-25	55mm	408+6125	\$5,80
T-27	55mm	408+6127	\$5,80
T-30	55mm	408+6130	\$5,80
T-40	55mm	408+6140	\$6,30
T-45	55mm	410+6245	\$6,30
T-50	55mm	410+6250	\$7,10
T-55	55mm	440+6255	\$7,40

# GENIUS

## KROMAJLI UZUN LOKMALI TORX ALLENLER



1/4"

T-06	100mm	208+6506	\$11,00
T-07	100mm	208+6507	\$11,00
T-08	100mm	208+6508	\$11,00
T-09	100mm	208+6509	\$11,00
T-10	100mm	208+6510	\$11,00
T-15	100mm	208+6515	\$11,00
T-20	100mm	208+6520	\$11,00
T-25	100mm	208+6525	\$11,00
T-27	100mm	208+6527	\$11,00
T-30	100mm	208+6530	\$11,00
T-40	100mm	208+6540	\$11,00

3/8"

T-45	110mm	310+6545	\$11,00
T-50	110mm	310+6550	\$11,00
T-55	110mm	310+6555	\$11,00

## KROMAJLI LOKMALI DÜZ TORNAVIDA UÇLARI



1/4"

0,8x4	26mm	222640	\$4,50
1x5,5	26mm	222655	\$4,50
1,2x6,5	26mm	222665	\$4,50
1,2x8	26mm	222680	\$4,50
1,6x10	26mm	222695	\$4,50

## KROMAJLI LOKMALI YILDIZ TORN. UÇLARI



1/4"

Ph1	26mm	222601	\$4,70
Ph2	26mm	222602	\$4,70
Ph3	26mm	222603	\$4,70
Ph4	26mm	222604	\$4,70

## KROMAJLI KISA LOKMALI DELİKLİ TORX ALLENLER



1/2"

T-20	55mm	408+7120	\$5,80
T-25	55mm	408+7125	\$5,80
T-27	55mm	408+7127	\$5,80
T-30	55mm	408+7130	\$5,80
T-40	55mm	408+7140	\$7,10
T-45	55mm	410+7145	\$7,10
T-50	55mm	410+7150	\$7,70
T-55	55mm	440+7155	\$8,40
T-60	60mm	442+7160	\$9,70
T-70	60mm	444+7170	\$9,70

## KROMAJLI KARE LOKMALAR



1/4"

Ölçü mm	Boy mm	KISA
8	25	\$5,50
10	25	\$5,50

## HAVALI TORX LOKMALAR



1/2"

Ölçü Ftx	Boy mm	KISA
E.8	38	\$5,60
E.10	38	\$5,60
E.11	38	\$5,60
E.12	38	\$5,60
E.14	38	\$5,60
E.16	38	\$5,60
E.18	40	\$6,30
E.20	40	\$6,70
E.22	40	\$7,20
E.24	40	\$7,50
E.26	44	\$12,50
E.28	44	\$12,50
E.30	46	\$12,50
E.32	46	\$12,50

3/4"

Ölçü Ftx	Boy mm	KISA
E.20	50	\$29,40
E.22	50	\$29,40
E.24	50	\$29,40
E.28	60	\$29,40
E.30	60	\$29,40

## KROMAJLI UZUN LOKMALI DELİKLİ TORX ALLENLER



1/2"

T-30	80mm	408+7330	\$9,30
T-40	80mm	408+7340	\$9,30

# GENIUS

## KROMAJLI TORX LOKMALAR



1/4"		
Ölçü Ftx	Boy mm	KISA
E.4	22	\$4,60
E.5	22	\$4,60
E.6	22	\$4,60
E.7	22	\$4,60
E.8	22	\$4,60
E.10	22	\$4,60

3/8"		
Ölçü Ftx	Boy mm	KISA
E.10	28	\$6,20
E.11	28	\$6,20
E.12	28	\$6,20
E.14	28	\$6,20
E.16	28	\$6,20
E.18	28	\$6,20
E.20	28	\$6,20

1/2"		
Ölçü Ftx	Boy mm	KISA
E.10	38	\$8,20
E.11	38	\$8,20
E.12	38	\$8,20
E.14	38	\$8,20
E.16	38	\$8,20
E.18	40	\$8,20
E.20	40	\$8,20
E.22	40	\$8,20
E.24	40	\$8,20

## 3/8" SOKETLİ ALTİKÖŞE HAVALI LOKMALAR



Ölçü mm/inç	Boy mm	KISA	Boy mm	UZUN
7	28	\$2,80		
8	28	\$2,80		
10	28	\$2,80	63	\$5,40
11	30	\$2,80	63	\$5,40
12	30	\$2,80	63	\$5,40
13	30	\$2,80	63	\$5,40
14	30	\$2,80	63	\$5,40
15	30	\$3,10	63	\$5,60
16			63	\$5,60
17	32	\$3,40	63	\$6,30
18			63	\$6,80
19	32	\$3,70	63	\$6,80
5/16	28	\$3,20		
3/8	28	\$3,20		
7/16	30	\$3,20		
1/2	30	\$3,20		
9/16	30	\$3,20		
5/8	30	\$3,90		
11/16	32	\$4,10		
3/4	32	\$5,10		

## 1/2" SOKETLİ ALTİKÖŞE HAVALI LOKMALAR



Ölçü mm/inç	Boy mm	KISA	Boy mm	UZUN
8	38	\$2,80	78	\$5,60
9	38	\$2,80	78	\$5,60
10	38	\$2,80	78	\$5,60
11	38	\$2,80	78	\$5,60
12	38	\$2,80	78	\$5,60
13	38	\$2,80	78	\$5,60
14	38	\$2,80	78	\$5,60
15	38	\$2,80	78	\$5,60
16	38	\$2,80	78	\$5,60
17	38	\$3,00	78	\$5,60
18	38	\$3,50	78	\$6,00
19	40	\$3,50	78	\$6,20
20	40	\$3,90	78	\$6,50
21	40	\$3,90	78	\$6,40
22	42	\$4,40	78	\$7,60
23	42	\$4,80	78	\$7,90
24	44	\$4,80	78	\$7,90
25	44	\$5,30	78	\$8,50
26	44	\$5,30	78	\$8,50
27	46	\$5,30	78	\$8,80
28	46	\$6,00	78	\$9,40
29	46	\$6,00	78	\$9,40
30	46	\$6,70	78	\$11,00
32	46	\$7,30	78	\$11,50
36	48	\$22,80	78	\$43,50
39	50	\$65,00		
5/16	38	\$3,30	78	\$6,50
3/8	38	\$3,30	78	\$6,50
7/16	38	\$3,30	78	\$6,50
1/2	38	\$3,30	78	\$6,50
9/16	38	\$3,30	78	\$6,50
5/8	38	\$3,30	78	\$6,50
11/16	38	\$3,50	78	\$6,50
3/4	40	\$4,10	78	\$8,60
13/16	40	\$4,60	78	\$8,70
7/8	42	\$5,10	78	\$8,80
15/16	44	\$5,50	78	\$8,80
1	44	\$6,40	78	\$10,30
1.1/16	46	\$6,40	78	\$10,30
1.1/8	46	\$7,00	78	\$11,00
1.3/16	46	\$7,80	78	\$12,80
1.1/4	46	\$8,50	78	\$13,40

## 1/2" SOKETLİ YILDIZ HAVALI LOKMALAR



Ölçü mm	Boy mm	KISA
36	48	\$22,80

## 1/2" SOKETLİ ALTİKÖŞE MAFSALLI HAVALI LOKMALAR



Ölçü mm	Boy mm	KISA
19	66	\$27,50

# GENIUS

## 3/4" SOKETLİ ALTİKÖŞE HAVALI LOKMALAR



Ölçü mm/inç	Boy mm	KISA	Boy mm	UZUN
17	51	\$11,40	90	\$16,20
18	51	\$11,40	90	\$16,20
19	51	\$11,40	90	\$16,20
20	51	\$11,40	90	\$16,20
21	51	\$11,40	90	\$16,20
22	51	\$11,40	90	\$16,20
23	51	\$11,40	90	\$16,20
24	51	\$11,40	90	\$16,20
26	54	\$11,40	90	\$16,20
27	54	\$11,40	90	\$16,20
28	54	\$11,40	90	\$16,70
29	54	\$11,40	90	\$17,10
30	54	\$11,40	90	\$17,10
32	57	\$12,30	90	\$17,10
33	57	\$12,30	90	\$18,40
34	57	\$12,30	90	\$18,40
35	57	\$12,80	90	\$21,00
36	57	\$13,20	90	\$21,00
38	57	\$13,70	90	\$22,80
40			90	\$27,20
41	58	\$15,20	90	\$27,20
42	58	\$23,70	90	\$29,80
43			90	\$29,80
45			95	\$29,80
46	63	\$23,70	95	\$29,80
50	68	\$25,80	100	\$36,80
52	70	\$28,90		
54	73	\$28,90		
55	73	\$28,90	100	\$45,50
57	73	\$35,90		
58	73	\$35,90		
60	84	\$35,90	105	\$99,20
65	85	\$46,40	105	\$132,20
70	90	\$55,10		
75	90	\$206,80		
11/16	51	\$13,60		
3/4	51	\$13,60	90	\$17,50
13/16	51	\$13,60		
7/8	51	\$13,60	90	\$17,50
15/16	51	\$13,60	90	\$17,50
1	54	\$13,60	90	\$17,50
1,1/16	54	\$14,00		
1,1/8	54	\$14,00	90	\$21,90
1,1/4	57	\$14,00	90	\$21,90
1,5/16	57	\$14,90	90	\$23,80
1,3/8	57	\$14,90	90	\$26,30
1,7/16	57	\$16,70	90	\$28,00
1,1/2	57	\$16,70	90	\$28,00
1,5/8	58	\$17,70	90	\$39,40
1.11/16	60	\$21,20		
1,3/4	63	\$25,70		
1,7/8	65	\$25,70		
2	68	\$25,70		
2,1/16	70	\$25,70		
2,1/4	73	\$25,70		
2,5/16	73	\$33,80		
2,3/8	80	\$41,00		
2,1/2	80	\$47,00		

## 3/4" SOKETLİ YILDIZ HAVALI LOKMALAR



Ölçü mm	Boy mm	KISA
17	51	\$18,20
19	51	\$18,20
50	68	\$48,00
65	85	\$141,70
15/16	51	\$21,70
1.1/16	54	\$22,40
1.1/8	54	\$22,40

## 1" SOKETLİ KARE HAVALI LOKMALAR



Ölçü mm/inç	Boy mm	KISA	Boy mm	UZUN
17	60	\$29,80	90	\$34,30
19	60	\$29,80	90	\$34,30
21	60	\$29,80	90	\$34,30
22			90	\$34,30
3/4	60	\$29,80		
13/16	60	\$29,80		

## 1" SOKETLİ ALTİKÖŞE HAVALI LOKMALAR



Ölçü mm/inç	Boy mm	KISA	Boy mm	UZUN
17	60	\$16,30	90	\$21,50
19	60	\$16,30	90	\$21,50
20			90	\$21,50
21	60	\$16,30	90	\$21,50
22	60	\$16,30	90	\$21,50
23	60	\$16,30	90	\$21,50
24	60	\$16,30	90	\$21,50
25			90	\$21,50
26	60	\$16,30	90	\$21,50
27	60	\$16,30	90	\$21,90
28	60	\$16,30	90	\$21,90
29	60	\$16,30	90	\$21,90
30	62	\$16,30	90	\$21,90
31			90	\$23,70
32	63	\$16,30	90	\$23,70
33	63	\$17,50	90	\$23,70
34	63	\$17,50	90	\$24,50
35	63	\$17,50	90	\$26,30
36	67	\$18,90	90	\$26,30
38	67	\$19,90	90	\$30,70
41	70	\$21,50	90	\$32,40

# GENIUS

## 1" SOKETLİ ALTİKÖŞE HAVALI LOKMALAR



Ölçü mm/inç	Boy mm	KISA	Boy mm	UZUN
42	70	\$25,90		
46	70	\$25,90	100	\$37,40
50	70	\$30,70	100	\$44,20
52	82	\$40,90		
55	87	\$40,90	110	\$57,80
57	87	\$50,80		
58	87	\$50,80		
60	91	\$50,80	110	\$75,30
63	91	\$56,90		
65	95	\$56,90	120	\$96,20
70	100	\$77,00	125	\$122,50
75	105	\$103,20	150	\$144,30
80	105	\$118,10	150	\$165,80
85	110	\$133,80	160	\$354,70
90	110	\$164,50	160	\$367,00
95	120	\$168,80	160	\$386,90
100	120	\$174,10		
105	120	\$360,20		
110	120	\$393,60		
115	120	\$466,90		
3/4	60	\$19,20		
13/16	60	\$19,20		
7/8	60	\$19,20		
15/16	60	\$19,20		
1	60	\$19,20		
1,1/16	60	\$19,20		
1,1/8	60	\$19,20		
1,3/16	62	\$19,20		
1,1/4	63	\$19,20		
1,5/16	63	\$21,00		
1,3/8	63	\$21,00		
1,7/16	67	\$22,80		
1,1/2	67	\$22,80		
1,5/8	70	\$26,30		
1,11/16	70	\$28,90		
1,3/4	70	\$29,80		
1,13/16	70	\$31,50		
1,7/8	70	\$33,30		
2	70	\$38,50		
2,1/16	82	\$38,50		
2,1/8	82	\$41,10		
2,3/16	87	\$60,40		
2,1/4	87	\$55,10		
2,5/16	87	\$56,40		
2,3/8	91	\$51,60		
2,7/16	91	\$66,50		
2,1/2	91	\$66,50		
2,5/8	95	\$76,10		
2,3/4	100	\$85,80		
2,7/8	100	\$131,20		
2,15/16	105	\$132,30		
3	105	\$135,80		
3,1/8	105	\$150,50		

## 1.1/2" SOKETLİ ALTİKÖŞE HAVALI LOKMALAR



Ölçü mm	Boy mm	KISA	Boy mm	UZUN
41	80	\$183,70	120	\$237,00
46	84	\$183,70	130	\$237,00
50	84	\$194,40		
55	90	\$198,60	150	\$316,00
60	90	\$206,60	150	\$329,00
65	95	\$223,00	150	\$360,00
70	100	\$245,80	150	\$394,00
75	105	\$264,40	160	\$424,00
80	110	\$302,40	170	\$485,00
85	110	\$339,10	170	\$545,00
90	112	\$369,60		
95	112	\$416,20		
100	115	\$451,10		
105	120	\$523,30		
110	124	\$531,90		
115	128	\$660,10		
120	132	\$661,90		
125	136	\$842,30		
130	140	\$1.212,90		
135	145	\$1.590,80		
140	150	\$2.401,20		
145	155	\$2.834,80		
150	160	\$3.301,70		

## 2.1/2" SOKETLİ ALTİKÖŞE HAVALI LOKMALAR



Ölçü mm	Boy mm	KISA
125	165	\$1.604,30

## 1/4" SOKETLİ ALTİKÖŞE KROMAJLI LOKMALAR



Ölçü mm/inç	Boy mm	KISA	Boy mm	UZUN
8			50	\$4,90
10			50	\$4,90
1/8	25	\$2,50		
1/4	25	\$2,50	50	\$8,20
19/32	25	\$2,50		



# GENIUS

## 3/8" SOKETLİ ALTİKÖŞE KROMAJLI LOKMALAR



Ölçü mm/inç	Boy mm	KISA	Boy mm	UZUN
7	28	\$3,30		
8	28	\$3,30	63	\$8,40
9			63	\$8,40
10	28	\$3,30	63	\$8,40
11	30	\$3,30	63	\$8,40
12			63	\$8,40
13	30	\$3,30	63	\$8,40
14	30	\$3,30	63	\$8,40
15	30	\$4,20	63	\$9,70
16	30	\$4,20	63	\$9,70
17	32	\$4,20	63	\$9,70
18	32	\$4,20	63	\$9,70
19	32	\$4,20	63	\$9,70
1/4	28	\$4,20	63	
5/16			63	\$14,50
3/8			63	\$14,50
7/16			63	\$14,50
1/2			63	\$14,50
9/16			63	\$14,50
19/32	30	\$5,70	63	\$16,10
5/8			63	\$16,10
11/16			63	\$16,10
3/4			63	\$16,10
25/32	32	\$6,40	63	\$19,20
13/16	32	\$6,40	63	\$19,20
7/8	32	\$6,40	6	\$19,20

## 1/2" SOKETLİ ALTİKÖŞE KROMAJLI LOKMALAR



Ölçü mm/inç	Boy mm	KISA	Boy mm	UZUN
8	38	\$3,60	78	\$14,10
9	38	\$3,60	78	\$14,10
10	38	\$3,60	78	\$14,10
11	38	\$3,60	78	\$14,10
12	38	\$3,60	78	\$14,10
13	38	\$3,60	78	\$14,10
14	38	\$3,60	78	\$14,10
15	38	\$4,90	78	\$15,20
16	38	\$4,90	78	\$15,20
17	38	\$4,90	78	\$15,20
18	38	\$4,90	78	\$15,20
19	40	\$6,40	78	\$16,10
20	40	\$6,40	78	\$16,10
21	40	\$6,40	78	\$16,10
22	42	\$6,40	78	\$16,10
23	42	\$7,40	78	\$17,70
24	42	\$7,40	78	\$17,70
26	42	\$7,40	78	\$17,70
27	42	\$7,40	78	\$17,70
28	42	\$8,90	78	\$19,20
29	42	\$8,90		
30	42	\$8,90	78	\$19,20
32	42	\$8,90	78	\$19,20
36	44	\$14,50	78	\$32,30
5/16	38	\$4,90	78	\$14,50
3/8	38	\$4,90	78	\$14,50
7/16	38	\$4,90	78	\$14,50
1/2	38	\$4,90	78	\$14,50
9/16	38	\$4,90	78	\$14,50
5/8	38	\$6,40	78	\$16,10
11/16	38	\$6,40	78	\$16,10
3/4	40	\$6,40	78	\$16,10
13/16	40	\$8,90	78	\$19,20
7/8	42	\$8,90	78	\$19,20
15/16	44	\$8,90	78	\$19,20
1	44	\$8,90	78	\$19,20
1,1/16	46	\$10,60	78	\$19,80
1,1/8	46	\$10,60	78	\$19,80
1,3/16	46	\$10,60	78	\$22,10
1,1/4	46	\$10,60	78	\$25,60

## 1/2" SOKETLİ YILDIZ KROMAJLI LOKMALAR



Ölçü mm/inç	Boy mm	KISA	Boy mm	UZUN
8			78	\$14,10
10			78	\$14,10
13	38	\$3,60	78	\$14,10
14	38	\$3,60	78	\$14,10
17	38	\$4,90	78	\$15,20
19	40	\$6,40	78	\$16,10
22			78	\$19,20
24			78	\$19,20
27	46	\$7,40	78	\$19,20
30	46	\$8,90	78	\$19,20
32			78	\$19,20
1/2	38	\$4,90	78	\$14,50
9/16			78	\$14,50
5/8	38	\$6,40	78	\$16,10
11/16			78	\$16,10
3/4			78	\$16,10
13/16			78	\$19,20
15/16			78	\$19,20
1			78	\$19,20
1.1/8			78	\$19,20



# GENIUS

## 3/4" SOKETLİ ALTİKÖŞE KROMAJLI LOKMALAR



Ölçü mm/inç	Boy mm	KISA	Boy mm	UZUN
17	51	\$16,10		
19	51	\$16,10		
22	51	\$16,10		
24	51	\$16,10	90	\$25,60
36	57	\$19,20		
50	68	\$41,60		
52	71	\$48,00		
55	75	\$48,00		
58	78	\$56,00		
60	80	\$56,00		
65	85	\$87,90		
70	90	\$103,90		
3/4	51	\$16,10		
15/16	51	\$16,10		
1,1/8	54	\$31,90		
1,1/4	57	\$31,90		
1,5/16	57	\$31,90		
1,3/8	57	\$31,90		
1,7/16	57	\$31,90		
1,1/2	57	\$35,20		
1,5/8	58	\$35,20		
1,3/4	63	\$40,10		
1,7/8	65	\$40,10		
2,1/16	70	\$40,10		
2,3/16	73	\$56,00		
2,1/4	73	\$56,00		
2,5/16	73	\$56,00		
2,3/8	80	\$56,00		
2,7/16	80	\$56,00		
2,1/2	80	\$56,00		
2,5/8	85	\$73,50		
2,3/4	90	\$73,50		

## 3/4" SOKETLİ YILDIZ KROMAJLI LOKMALAR



Ölçü mm/inç	Boy mm	KISA
17	51	\$16,10
19	51	\$16,10
21	51	\$16,10
22	51	\$16,10
23	51	\$16,10
24	51	\$16,10
27	54	\$19,20
30	54	\$19,20
32	57	\$19,20
35	57	\$19,20
36	57	\$19,20
41	58	\$35,20
46	63	\$40,10
50	68	\$48,00
54	73	\$48,00
55	73	\$48,00
58	73	\$56,00
60	80	\$56,00
65	85	\$114,90
70	90	\$114,90
7/8	51	\$16,10
15/16	51	\$16,10
1"	54	\$16,10
1,1/16	54	\$31,90
1,1/8	54	\$31,90
1,3/16	54	\$31,90
1,1/4	57	\$31,90
1,5/16	57	\$31,90
1,3/8	57	\$31,90
1,7/16	57	\$31,90
1,1/2	57	\$35,20
1,5/8	58	\$35,20
1,3/4	63	\$40,10
1,13/16	63	\$40,10
1,7/8	65	\$40,10
2	68	\$40,10
2,1/16	71	\$56,00
2,1/4	73	\$56,00
2,5/8	85	\$73,50
2,3/4	90	\$73,50

## 1" SOKETLİ ALTİKÖŞE KROMAJLI LOKMALAR



Ölçü mm/inç	Boy mm	KISA
36	67	\$61,30
38	67	\$61,30
41	70	\$61,30
43	70	\$61,30
46	70	\$61,30
50	70	\$63,80
54	82	\$67,10
55	87	\$67,10
58	87	\$79,90
60	91	\$79,90
63	91	\$87,90
65	95	\$87,90
70	100	\$103,90
75	105	\$111,80
80	105	\$127,60
85	110	\$183,60
90	110	\$231,50
95	120	\$306,30
100	120	\$382,80
105	120	\$510,40
110	120	\$558,40
115	120	\$630,20
2,1/4	87	\$95,70
2,5/16	87	\$95,70
2,3/8	91	\$103,90
2,7/16	91	\$111,80

## 1" SOKETLİ YILDIZ KROMAJLI LOKMALAR



Ölçü mm/inç	Boy mm	KISA
36	67	\$72,00
38	67	\$79,90
41	70	\$79,90
46	70	\$95,70
50	70	\$111,80
55	87	\$127,60
60	91	\$127,60
65	95	\$153,20
70	100	\$153,20
75	105	\$175,60
80	105	\$239,40
85	110	\$287,10
90	110	\$350,90
95	120	\$382,80
2,1/4	87	\$143,70
2,3/8	91	\$143,70
2,1/2	91	\$160,00
2,5/8	95	\$175,60
2,3/4	100	\$175,60
3,1/8	105	\$335,10
2,1/2	91	\$111,80
2,5/8	95	\$112,10
2,3/4	100	\$127,60
3,1/8	105	\$207,50



## HİDROLİK MİL



8-0-621 (8-01)	10 Ton / G1/2" 12-4/5,18-2,20-2/20,30-2/20 41-5,42-5,205-02,206-02,207-02	€ 355,20
8-0-626 (8-02)	12 Ton / G3/4" 12-6/7,18-3,20-3/30,30-3 205-1/2/3,206-1/2/3,207-1/2/3	€ 441,60

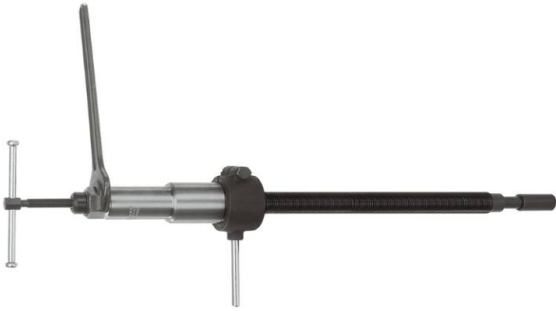

8-1-B	15 Ton / G1" 11-0,18-4,20-4/40	€ 758,40
8-1-F	15 Ton / G1" 46-1/2,47-1/2	€ 780,80
8-2-K	20 Ton / G1.1/8" 11-1/2	€ 918,40
8-2-M	20 Ton / G1.1/8" 18-5,20-5	€ 1.059,20



800	10 Ton / G1.1/2" 128,129	€ 201,60
-----	-----------------------------	----------

## ÇEKTİRME HİDROLİĞİ



9-1	10mm / 10 Ton	€ 233,60
9-2	15mm / 15 Ton	€ 291,20
9-3	7mm / 30 Ton	€ 707,20

## ÜÇ AYAKLI ÇEKTİRME



11-0-A	375x200mm	€ 1.276,80
11-1-A	520x200mm	€ 1.504,00
11-2-A	650x200mm	€ 1.686,40

## HİDROLİK MİLLİ ÜÇ AYAKLI ÇEKTİRME



11-0-B	15 Ton 375x200mm	€ 1.932,80
11-0-BV	15 Ton 375x300-500mm	€ 2.134,40
11-1-B	20 Ton 520x200mm	€ 2.620,80
11-2-B	20 Ton 650x200mm	€ 2.256,00

## ÜÇ AYAKLI ÇEKTİRME



12-1	100x100mm	€ 179,20
12-2	150x125mm	€ 259,20
12-3	200x180mm	€ 380,80

## İKİ AYAKLI ÇEKTİRME



14-1	6-100x85mm	€ 192,00
14-2	10-140x125mm	€ 275,20
14-3	15-140x160mm	€ 336,00

## RULMAN ÇEKTİRME TABANI



15-0	5-60mm	€ 96,00
15-1	12-75mm	€ 124,80
15-2	22-115mm	€ 192,00
15-3	25-155mm	€ 310,40
15-4	30-200mm	€ 886,40
15-5	30-250mm	€ 1.260,80

## RULMAN ÇEKTİRME TAKIMI



15-K	5-60mm	€ 323,20
15-A	12-75mm	€ 451,20
15-B	22-115mm	€ 547,20
15-C	25-155mm	€ 867,20
15-D	30-200mm	€ 2.073,60
15-E	30-250mm	€ 2.633,60

## RULMAN İÇ ÇEKTİRME



16	60-155	€ 880,00
----	--------	----------

## RULMAN İÇ ÇEKTİRME



K-16	60-155mm	€ 1.024,00
------	----------	------------

## RULMAN ÇEKTİRME TABANI



17-0	5-60mm	€ 144,00
17-1	12-75mm	€ 188,80
17-2	22-115mm	€ 272,00
17-3	25-155mm	€ 441,60

## RULMAN ÇEKTİRME TAKIMI



17-K	5-60mm	€ 387,20
17-A	12-75mm	€ 464,00
17-B	22-115mm	€ 668,80
17-C	25-155mm	€ 934,40

## İKİ AYAKLI ÇEKTİRME



20-1+	90x100mm	€ 137,60
20-10+	120x100mm	€ 147,20
20-2+	160x150mm	€ 256,00
20-20+	200x150mm	€ 300,80
20-3+	250x200mm	€ 473,60
20-30+	350x200mm	€ 515,20

## RULMAN ÇEKTİRME AYAĞI



18-0	15-0 için	€ 83,20
18-1	15-1 için	€ 147,20
18-2	15-2 için	€ 217,60
18-3	15-3 için	€ 364,80
18-4	15-4 için	€ 880,00
18-5	15-5 için	€ 1.280,00

## HİDROLİK MİLLİ İKİ AYAKLI ÇEKTİRME



20-2+B	160x150mm 8-01 / 7 Ton	€ 588,80
20-20+B	200x150mm 8-01 / 7 Ton	€ 624,00
20-3+B	250x200mm 8-02 / 10 Ton	€ 848,00
20-30+B	350x200mm 8-02 / 10 Ton	€ 864,00
20-4-B	520x200mm 8-1-B / 15 Ton	€ 1.670,40

## İKİ AYAKLI ÇEKTİRME



20-3-4	250X400	€ 470,40
20-4	520x200mm	€ 905,60
20-5	750x400-700mm	€ 3.462,40

## İKİ AYAKLI ÇEKTİRME



20-1+S	90x100mm	€ 144,00
20-10+S	120x100mm	€ 153,60
20-2+S	160x150mm	€ 265,60

## İKİ AYAKLI ÇEKTİRME TAKIMI



20-ST+	20-1+/10+/2+/20+/3+	€ 1.315,20
--------	---------------------	------------

## İKİ AYAKLI ÇEKTİRME TAKIMI



20-10-SP	120x100-350mm	€ 416,00
----------	---------------	----------

## ÇEKTİRME AYAKLARI (2'Lİ TAKIMLAR)

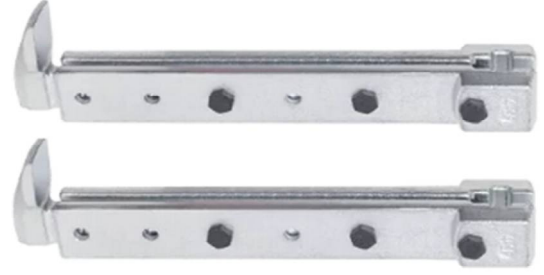

4-SP-P	300-500mm-20-3/30,20-4/40	€ 627,20
5-SP-P	400-700mm---20-5	€ 1.174,40



x-xx0-P

x-xx2-P

1-90-P	100mm--20-1/10	€ 64,00
1-190-P	200mm--20-1/10	€ 115,20
1-250-P	250mm--20-1/10	€ 134,40
2-150-P	150mm--20-2/20	€ 118,40
2-300-P	300mm--20-2/20	€ 214,40
3-200-P	200mm--20-3/30	€ 252,80
3-300-P	300mm--20-3/30	€ 304,00
3-400-P	400mm--20-3/30	€ 332,80
3-500-P	500mm--20-3/30	€ 386,00

1-92-P	100mm--20-1+/10+	€ 67,20
1-192-P	200mm--20-1+/10+	€ 140,80
1-252-P	250mm--20-1+/10+	€ 140,80
2-152-P	150mm--20-2+/20+	€ 124,80
2-302-P	300mm--20-2+/20+	€ 230,40
3-202-P	200mm--20-3+/30+	€ 307,20
3-302-P	300mm--20-3+/30+	€ 332,80
3-402-P	400mm--20-3+/30+	€ 352,00
3-502-P	500mm--20-3+/30+	€ 400,00



x-xx1-P

x-xx3-P

1-91-P	100mm--20-1S/10S	€ 96,00
1-191-P	200mm--20-1S/10S	€ 137,60
1-251-P	250mm--20-1S/10S	€ 156,80
2-151-P	150mm--20-2S/20S	€ 198,40
2-301-P	300mm--20-2S/20S	€ 291,20
3-201-P	200mm--20-3S/30S	€ 288,00
3-301-P	300mm--20-3S/30S	€ 339,20
3-401-P	400mm--20-3S/30S	€ 393,60
3-501-P	500mm--20-3S/30S	€ 572,80

1-93-P	100mm--20-1+S/10+S	€ 99,20
1-193-P	200mm--20-1+S/10+S	€ 124,80
1-253-P	250mm--20-1+S/10+S	€ 150,40
2-153-P	150mm--20-2+S/20+S	€ 182,40
2-303-P	300mm--20-2+S/20+S	€ 224,00
3-203-P	200mm--20-3+S/30+S	€ 307,20
3-303-P	300mm--20-3+S/30+S	€ 387,20
3-403-P	400mm--20-3+S/30+S	€ 428,80
3-503-P	500mm--20-3+S/30+S	€ 608,00

## GENEL AMAÇLI ÇEKTİRME TAKIMI



K-20-15 € 1.670,40

## İKİ VE ÜÇ AYAKLI ÇEKTİRME TAKIMI



K-2030 10+S+T 120-130x100-350mm € 886,40

## PARÇALANMIŞ RULMAN ÇEKTİRMESİ



KS-22-01 3-10mm 1,70 Kg € 192,00

## İÇ ÇEKTİRME



23 5-32mm € 201,60

## RULMAN İÇ ÇEKTİRME TUTUCUSU



21-0	5-8mm / 22-1	€ 89,60
21-00	6-10mm / 22-1	€ 89,60
21-01	8-12mm / 22-1	€ 89,60
21-02	10-14mm / 22-1	€ 89,60
21-1	12-16mm / 22-1	€ 89,60
21-2	14-19mm / 22-1	€ 89,60
21-3	18-23mm / 22-1,22-2	€ 89,60
21-4	20-30mm / 22-1,22-2	€ 89,60
21-5	28-40mm / 22-1,22-2	€ 99,20
21-6	35-46mm / 22-2,22-3	€ 112,00
21-7	45-58mm / 22-2,22-3	€ 150,40
21-8	56-70mm / 22-2,22-3	€ 188,80
21-9	70-100mm / 22-3	€ 300,80
21-89	56-110mm / 22-4	€ 435,20
21-90	100-200mm / 22-5	€ 569,60

## VURMALI TİP RULMAN İÇ ÇEKTİRME AYAĞI



22-0-05	0,5kg 21-0...21-5	€ 89,60
22-0-17	1,7kg 21-3...21-9	€ 246,60

## RULMAN İÇ ÇEKTİRME AYAĞI



22-1	21-0...21-5	€ 89,60
22-2	21-3...21-8	€ 124,80
22-3	21-6...21-9	€ 246,40
22-4	21-89	€ 297,60
22-5	21-90	€ 336,00

## RULMAN ÇEKTİRME TAKIMI



24-A	21-1..21-6 22-1/2,23,43-1,20-1	€ 1.369,60
24-B	21-1..21-8 22-1/2,23,43-1,20-1/2	€ 2.003,20
24-C	21-1..21-7,21-89 22-1/2/4,23,43-1,20-1/2	€ 2.611,20

## VURMALI TİP RULMAN İÇ ÇEKTİRME TAKIMI



K-26-A	6-30mm 21-00/02/2/4,22-0-05/6-22	€ 416,00
K-26-B	28-70mm 21-5/6/7/8,22-0-10/6-22	€ 635,00
26-B	6-40mm 21-00/01/1/2/4/5,22-0/0-1	€ 771,20

## RULMAN İÇ ÇEKTİRME TAKIMI



K-22-A	21-00/02/2/3/4 22-0,22-1	€ 499,20
K-22-C-E	21-0E/00E/01E/1E/2E 21-3E/4E 22-0,22-1	€ 748,80

## ÜÇ AYAKLI ÇEKTİRME



30-1+	90x100mm	€ 195,20
30-10+	130x100mm	€ 204,80
30-2+	160x150mm	€ 358,40
30-20+	200x150mm	€ 422,40
30-3+	250x200mm.	€ 665,60

## RULMAN İÇ ÇEKTİRME TAKIMI



25-K	6-19mm 21-00/02/2,22-1	€ 432,00
25-A	12-46mm 21-1..21-6,22-1/2	€ 854,40
25-B	12-70mm 21-1..21-8,22-1/2	€ 1.203,20
25-C	12-110mm 21-1..21-7/89,22-1/2/4	€ 1.769,60

## HİDROLİK MİLLİ ÜÇ AYAKLI ÇEKTİRME



30-2+B	160x150mm 8-01 / 7 Ton	€ 665,60
30-20+B	200x150mm 8-01 / 7 Ton	€ 678,40
30-3+B	250x200mm 8-02 / 10 Ton	€ 1.068,80

## GENEL AMAÇLI ÇEKTİRME TAKIMI

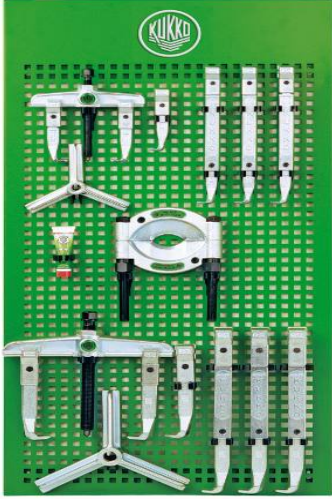

30-20-T	20-1/10,30-1/10 20-2/20/3,30-2/20/3	€ 1.628,80
---------	--	------------

## KAMPANA ÇEKTİRMESİ



40-3	3 ayak / 225mm	€ 358,40
40-5	5 ayak / 225mm	€ 448,00

## DİREKSİYON ÇEKTİRMESİ



31-1	30-60mm	€ 432,00
31-2	80-90mm	€ 432,00



32-1	100mm	€ 339,20
32-2	120mm	€ 448,00



33	Opel için	€ 198,40
----	-----------	----------

## İKİ AYAKLI ÇEKTİRME



41-0	60x40mm	€ 41,60
41-1	65x65mm	€ 41,60
41-2	80x80mm	€ 48,00
41-3	90x120mm	€ 92,80

## ÜÇ AYAKLI ÇEKTİRME



42-0	60x40mm	€ 54,40
42-1	65x65mm	€ 54,40
42-2	80x80mm	€ 67,20

## İKİ VE ÜÇ AYAK İNCE AYAKLI ÇEKTİRME



43-001	60x50mm	€ 95,90
43-011	60x50mm	€ 121,40

## İKİ AYAKLI ÇEKTİRME



44-1	100x100mm	€ 67,20
44-2	120x120mm	€ 108,80
44-3	160x160mm	€ 166,40
44-4	250x200mm	€ 227,20
44-5	300x250mm	€ 300,80

## İKİ AYAK İNCE AYAKLI ÇEKTİRME



43-1	60x50mm	€ 57,60
43-2	70x70mm	€ 57,60
43-3	80x80mm	€ 60,80

## ÜÇ AYAKLI ÇEKTİRME



45-1	100x100mm	€ 102,40
45-2	120x120mm	€ 153,60
45-3	160x160mm	€ 230,40
45-4	250x200mm	€ 326,40
45-5	300x250mm	€ 640,00

## ÜÇ AYAK İNCE AYAKLI ÇEKTİRME



43-11	60x50mm	€ 73,60
43-12	70x70mm	€ 73,60
43-13	80x80mm	€ 80,00

## İKİ AYAKLI ÇEKTİRME



46-1-A	300x300mm	€ 476,80
46-2-A	500x450mm	€ 601,60

# KUKKO

## HİDROLİK MİLLİ İKİ AYAKLI ÇEKTİRME



46-1-B	300x300mm 8-1-F / 15 Ton	€ 1.232,00
46-2-B	500x450mm 8-1-F / 15 Ton	€ 1.324,80

## İKİ AYAK İNCE AYAKLI ÇEKTİRME



48	60x40mm	€ 70,40
----	---------	---------

## ÜÇ AYAKLI ÇEKTİRME



47-1-A	300x300mm	€ 537,60
47-2-A	500x450mm	€ 716,80

## TERS KILAVUZ TAKIMI



49-A	5 p. / 3-18mm	€ 35,20
49-B	6 p. / 3-24mm	€ 41,60
49-C	8 p. / 3-45mm	€ 83,20

## HİDROLİK MİLLİ ÜÇ AYAKLI ÇEKTİRME



47-1-B	300x300mm 8-1-F / 15 Ton	€ 1.321,60
47-2-B	500x450mm 8-1-F / 15 Ton	€ 1.462,40

## SAPLAMA SÖKECEĞİ



50-1	5-10mm	€ 76,80
50-2	8-19mm	€ 105,60
50-3	18-25mm	€ 118,40

# KUKKO

## SAPLAMA SÖKECEĞİ



51-1	5-10mm	€ 76,80
51-2	8-19mm	€ 118,40
51-3	18-25mm	€ 140,80



52	5-19mm	€ 192,00
----	--------	----------

## SOMUN PATLATMA



54-2	10-27mm	€ 121,60
54-3	17-36mm	€ 156,80



55-0	4-10mm	€ 83,20
55-1	10-18mm	€ 99,20
55-2	19-27mm	€ 108,80
55-3	27-36mm	€ 140,80
55-4	32-50mm	€ 467,20

## ZİNCİR MONTAJ ÇEKTİRMESİ



58-1	9-46mm	€ 131,20
58-2	25,4-63,5mm	€ 220,80

## HİDROLİK SOMUN PATLATMA



56-1	7-24mm	€ 268,80
------	--------	----------



56-2	22-36mm	€ 496,00
56-2-C	22-36mm	€ 496,00



56-3	27-46mm	€ 723,20
------	---------	----------

## SOMUN PATLATMA SETİ



K-55-B	10-36mm 55-1 / 55-2 / 55-3 55-1-M / 22-2-M / 55-3-M	€ 435,20
--------	---	----------

## AMORTİSÖR YAY ÇEKTİRMESİ



67-1	80-195mm	€ 1.041,60
------	----------	------------

# KUKKO

## AMORTİSÖR YAY ÇEKTİRMESİ



65-0	200x110-180mm	€ 243,20
65-1	300x110-180mm	€ 265,60
65-2	400x110-180mm	€ 297,60



Çift tırnaklı

66-1	100-250 x 110-180mm	€ 291,20
66-2	200-400 x 110-180mm	€ 307,20
66-3	100-400 x 110-180mm	€ 364,80

## OTOMOTİV GRUBU ÇEKTİRME TAKIMI



K-65-A € 1.568,30

## RULMAN İÇ ÇEKTİRME TAKIMI



70-K	6000..6013,6200..6207 6300..6306	€ 1.036,80
70-A	6000..6013,6200..6212, 6300..6311,6403..6408	€ 1.612,80
70-B	6014..6021,6213..6222, 6312..6317,6409..6415	€ 3.017,60



70-1-S	70-1 / 70-712 / 70-713	€ 398,50
70-2-S	70-2 / 70-721 / 70-722	€ 448,20
70-3-S	70-3 / 70-731 / 70-732	€ 719,10

## RULMAN ÇEKTİRME TAKIMI



69-A	6004..6013,6201..6206 6300..6305	€ 371,20
69-B	6011..6020,6206..6212, 6305..6309,6403..6407	€ 502,40
69-C	6021..6032,6213..6230, 6310..6321,6406..6417	€ 1.075,20

## RULMAN ÇAKMA TAKIMI



71	26-110mm	€ 2.137,60
71L	18-52mm	€ 1.479,30

## DİŞ EĞESİ



97-1	DIN-ISO mm	€ 128,00
97-2	Whitworth+BSF	€ 128,00

## KAYIŞLI FİLTRE ANAHTARI



104	180mm	€ 54,40
-----	-------	---------

## SEGMAN YENGEÇİ



101-1	50-100mm	€ 73,60
101-2	90-150mm	€ 96,00

## ZİNCİRLİ FİLTRE ANAHTARI



104-32	110mm	€ 96,00
--------	-------	---------

## PİSTON PİM ÇIKARTMA



102-1	100mm	€ 188,80
-------	-------	----------

## ÇEMBERLİ FİLTRE ANAHTARI



105-0	70-110mm / Saplı	€ 92,80
-------	------------------	---------

## SUPAP İŞKENCESİ



103-1	60-230mm	€ 156,80
103-2	40-230mm	€ 176,70
103-3	115-290mm	€ 357,50



105-1	70-110mm/1/2" Soketli	€ 64,00
-------	-----------------------	---------

## AHTAPOT (ÜÇ AYAKLI) FİLTRE ANAHTARI



108-1	3/8" / 60-100mm	€ 51,20
108-2	3/8" / 65-120mm	€ 51,20
108-3	1/2" / 90-140mm	€ 278,40

## İKİ AYAKLI ÇEKTİRME



120-2	150x150mm	€ 182,40
120-3	250x200mm	€ 275,20
120-30	350x200mm	€ 326,40

## JANT ÇEKTİRMESİ

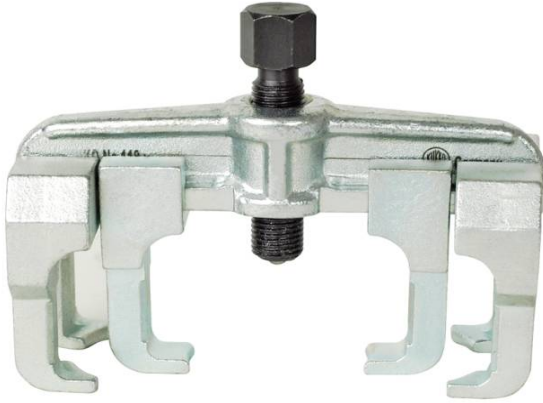

118-0	VW-Audi TDI	€ 297,60
-------	-------------	----------

## PİSTON MERKEZLEME APARATI



126-00	€ 217,60
--------	----------

## EGZOZ YAY ÇEKTİRMESİ

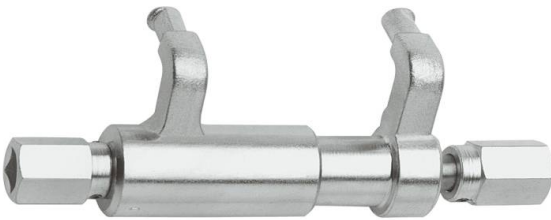

119-0	VW	€ 139,70
-------	----	----------

## EGZOZ MANİFOLT AYAR APARATI



119-1	VW	€ 86,90
-------	----	---------



126-30	€ 506,30
--------	----------

## ROT BAŞI ÇEKTİRMESİ



128-1	18mm	€ 57,60
128-2	23mm	€ 80,00
128-3	29mm	€ 105,60
128-4	39mm	€ 144,00
128-5	50mm	€ 208,00

## HİDROLİK MİLLİ ROT BAŞI ÇEKTİRMESİ



129-4-H	36-40mm 801 / 10 Ton	€ 576,00
---------	-------------------------	----------

## ROT ATTIRMA KOLU (ÇATALI)



135-1	18mm	€ 80,00
135-2	23mm	€ 80,00
135-3	29mm	€ 80,00
135-4	39mm	€ 80,00
135-5	45mm	€ 80,00

## ROT BAŞI ÇEKTİRMESİ



129-0	20mm	€ 153,60
-------	------	----------



129-1	18-22mm	€ 118,40
-------	---------	----------



129-2	16-22-32mm	€ 147,20
-------	------------	----------



129-3	34mm	€ 198,40
129-4	40mm	€ 211,20



129-5	36mm	€ 384,00
-------	------	----------

## MİKRO ÇEKTİRME



140-1	10x10mm	€ 38,40
140-2	15x15mm	€ 38,40
140-3	18x18mm	€ 38,40

## SİLECEK ÇEKTİRMESİ



142-1	15mm	€ 131,20
-------	------	----------

## SPEŞİYAL ÇEKTİRME



145-2	m10 / 75mm-Boy	€ 67,20
145-3	m12 / 90mm-Boy	€ 80,00

201-0	100x75mm	€ 57,60
201-1	150x85mm	€ 99,20
201-2	220x130mm	€ 153,60
201-3	300x260mm	€ 300,80
201-4	380x300mm	€ 352,00

## ÜÇ AYAKLI ÇEKTİRME



202-0	100x75mm	€ 73,60
202-1	150x85mm	€ 112,00
202-2	220x130mm	€ 195,20
202-3	300x260mm	€ 387,20
202-4	380x300mm	€ 441,60

## ÜÇ AYAKLI ÇEKTİRME



202-S	200x200mm	€ 179,20
-------	-----------	----------

## İKİ AYAKLI ÇEKTİRME



# KUKKO

## ÜÇ AYAKLI ÇEKTİRME



203-0	120x75mm	€ 80,00
203-1	180x85mm	€ 118,40
203-2	280x130mm	€ 204,80
203-3	350x260mm	€ 451,20
203-4	400x300mm	€ 505,60

## İKİ AYAKLI ÇEKTİRME



205-00	100x100mm	€ 60,80
205-01	150x150mm	€ 83,20
205-02	250x220mm	€ 137,60
205-1	300x280mm	€ 275,20
205-2	400x400mm	€ 374,40
205-3	500x540mm	€ 470,40

## İKİ AYAKLI KİLİTLİ ÇEKTİRME



204-0	50x70mm	€ 147,20
204-02	90x100mm	€ 227,20
204-1	80x90mm	€ 166,40
204-2	100x100mm	€ 188,80
204-3	150x140mm	€ 307,20

## HİDROLİK MİLLİ İKİ AYAKLI ÇEKTİRME



205-02-B	250x220mm 8-01 / 7 Ton	€ 457,60
205-1-B	300x280mm 8-02 / 10 Ton	€ 636,80
205-2-B	400x400mm 8-02 / 10 Ton	€ 739,20
205-3-B	500x540mm 8-02 / 12 Ton	€ 915,20

## İKİ AYAKLI ÇEKTİRME TAKIMI



K-204-V-210-1	204-2 210-1	€ 482,70
---------------	----------------	----------

# KUKKO

## ÜÇ AYAKLI ÇEKTİRME



206-00	100x100mm	€ 80,00
206-01	150x150mm	€ 105,60
206-02	250x220mm	€ 179,20
206-1	300x280mm	€ 339,20
206-2	400x400mm	€ 457,60
206-3	500x540mm	€ 585,06

## ÜÇ AYAKLI ÇEKTİRME



207-00	120x100mm	€ 83,20
207-01	200x150mm	€ 112,00
207-02	300x220mm	€ 188,80
207-1	400x280mm	€ 400,00
207-2	450x400mm	€ 486,40
207-3	550x540mm	€ 652,80

## HİDROLİK MİLLİ ÜÇ AYAKLI ÇEKTİRME



206-02-B	250x220mm 8-01 / 7 Ton	€ 496,00
206-1-B	300x280mm 8-02 / 10 Ton	€ 700,80
206-2-B	400x400mm 8-02 / 10 Ton	€ 809,60
206-3-B	500x540mm 8-02 / 12 Ton	€ 1.030,40

## HİDROLİK MİLLİ ÜÇ AYAKLI ÇEKTİRME



207-02-B	300x170mm 8-01 / 7 Ton	€ 505,60
207-1-B	400x230mm 8-02 / 10 Ton	€ 761,60
207-2-B	450x350mm 8-02 / 10 Ton	€ 844,80
207-3-B	550x490mm 8-02 / 12 Ton	€ 1.049,60

## İKİ AYAKLI ÇEKTİRME



208-0



208-01/02

208-0	100x50-75-100mm	€ 48,00
208-01	20-170x95-125mm	€ 99,20
208-02	20-230x150-190mm	€ 134,40

# KUKKO

## ÜÇ AYAKLI ÇEKTİRME



209-0

209-01/02

209-0	100x50-75-100mm	€ 67,20
209-01	20-170x95-125mm	€ 115,20
209-02	20-230x150-190mm	€ 172,80

## İKİ AYAKLI KİLİTLİ ÇEKTİRME



210-1	95x170mm	€ 275,20
210-2	135-270mm	€ 345,60
210-3	150x325mm	€ 393,60

## İKİ VE ÜÇ AYAKLI VURMALI ÇEKTİRME



220	0-130mm	€ 806,30
-----	---------	----------

## VURMALI ÇEKTİRME TAKIMI



223-K	3-16mm	€ 294,40
-------	--------	----------

## ÜÇ AYAKLI OTOMATİK ÇEKTİRME



225-1	m10 / 75mm-Boy	€ 419,20
225-2	m12 / 90mm-Boy	€ 419,20
225-3	m10 / 75mm-Boy	€ 419,20

# KUKKO

## PARÇA TUTMA İŞKENCESİ

1900-30	30mm	€ 115,20
1900-50	50mm	€ 131,20
1900-75	75mm	€ 192,00



## FLANŞ TİPİ AKS ÇEKTİRMESİ



230	Flanş çapı 100-150mm Aks civata ölçüsü 4-14mm	€ 256,00
-----	--	----------

## VURMALI ÜÇ AYAKLI ÇEKTİRME



243-12	70x70mm	€ 241,10
--------	---------	----------

## ÜÇ AYAKLI ÇEKTİRME



483-3	150x150mm	€ 188,80
-------	-----------	----------

## KASNAK DİŞLİ SABİTLEME APARATI



T-143	€ 272,30
-------	----------

## PLASTİK ÇEKİÇ SETİ



K- SELECTHOR 01	Plastik çekiç seti Lastik, Plastik ve Geri tepmesiz çekiç seti	€ 313,60
-----------------------	--	----------

## SPEŞİYAL ÇEKTİRME TAKIMI



K-142/4	43/1, 128-F-SW 142/1, 142/4	€ 412,80
---------	--------------------------------	----------



K-142/6	43/1, 128-F-SW 142/1, 142/2 142/3, 142/4 1007-16, 228-100	€ 652,80
---------	--	----------

## HİDROLİK ÜÇ AYAKLI ÇEKTİRME



8-HP-626

8-HP-626&45-5

8-HP-626 & 45-5	300x250mm 12 Ton	€ 1.836,80
8-HP-626	12 Ton / G3/4" 12-4,18-3,20-3/30,30-3/30 45-4/5,201-3/4,202-3/4,203-3/4 205-1/2/3,206-1/2/3,207-1/2/3	€ 1.196,80

## HİDROLİK ÇEKTİRMELER İÇİN POMPA



YHP-326	2mt Hortumu ve Manometresi ile birlikte Metal sandıkta	€ 1.476,00
---------	--	------------

## HİDROLİK İKİ VE ÜÇ AYAKLI ÇEKTİRME TAKIMI



Y28-256	500x300mm 20 Ton	€ 5.460,00
Y38-356	900x520mm 30 Ton	€ 8.488,00
Y58-556	1200x700mm 50 Ton	€ 14.308,00

## HİDROLİK İKİ-ÜÇ AYAKLI VE RULMAN ÇEKTİRME TAKIMI



Y28-200	500x300mm Rulman 25x155mm 20 Ton	€ 10.060,00
Y38-300	900x520mm Rulman 30x250mm 30 Ton	€ 14.680,00
Y58-500	1200x700mm Rulman 75x330mm 50 Ton	€ 25.096,00

## HİDROLİK İÇ VE DIŞ RULMAN ÇEKTİRME TAKIMI



Y28-218	140x30-180mm Rulman 25x155mm 20 Ton	€ 6.840,00
Y38-318	150x75-230mm Rulman 30x250mm 30 Ton	€ 11.280,00
Y58-518	150x75-230mm Rulman 75x330mm 50 Ton	€ 18.248,00