

SEVAN
HIRDAVAT

2024

FIYAT
LISTESİ

SEVAN HIRDAVATÇILIK TİC.SAN. A.Ş.

Değerli Dostlarımız;

1963 yılında İstanbul'un tarihi semtlerinden Karaköy'de şahıs firması olarak kurulan işletmemiz 1986 yılında şirketleşerek önce SEVAN HIRDAVATÇILIK SANAYİ VE TİCARET LİMİTED ŞİRKETİ, 2013 yılı itibariyle ise SEVAN HIRDAVATÇILIK SANAYİ VE TİCARET ANONİM ŞİRKETİ adı altında faaliyetini yine Karaköy'de kendi binasında devam ettirmektedir.

Müşterilerinin ihtiyacı olan ürünleri, gelişen teknolojinin sağladığı en son yeniliklerle, uluslararası standartlarda belirtilen özelliklere sahip olacak şekilde, ve en uygun koşullarda müşterilerine ulaştırmayı kendine ilke edinen işletmemizin, bu nedenledir ki, Türkiye geneline yayılmış oldukça geniş bir müşteri portföyü bulunmaktadır.

"Satışla başlayan dostluk" sloganıyla hareket eden SEVAN HIRDAVATÇILIK ,sattığı ürünlerin daima arkasında olmuş, satış sonrası hizmetlerini de eksiksiz yerine getirmektedir.

Bu amaçla başta havalı aletler olmak üzere, her türlü ürününün tamir ve bakım servis ağını müşterilerinin hizmetine sunmaktadır

Faaliyetini teknik hırdavat alanında sürdüren SEVAN HIRDAVATÇILIK , kendi alanında dünyanın en tanınmış, kalitesini uluslararası pazarlarda ıspatlamış markaların, Türkiye temsilciliğini sürdürmekte olup, ürünlerine ait fiyat listesini siz değerli dostlarımızın beğenisine sunmaktadır.



ISKONTO ORANLARIMIZ	
VADE	ISKONTO %
90 Gün vadeli alımlarda	15
Tek çekim kredi kartı ve havale ile	23,5



BANKA VE IBAN NUMARALARIMIZ		
BANKA	ŞUBE	IBAN
Akbank	Galata	TR04 0004 6000 1988 8000 026860
Finansbank	Karaköy	TR67 0011 1000 0000 0011 830392
Garanti Bankası	Galata	TR66 0006 2000 0670 0006 202542
İşbankası	Karaköy	TR47 0006 4000 0011 0280 034671
Vakıfbank	Karaköy	TR42 0001 5001 5800 7309 711994
Yapı Kredi Bankası	Perşembepazarı	TR14 0006 7010 0000 0061 408606

SEVAN HIRDAVATÇILIK TİCARET ve SANAYİ A.Ş.

Keresteci Fazıl Sokak No: 10

Tel:(212) 249 30 00 - 249 49 24 - 249 13 75 Fax:(212) 249 04 74

e-mail: sevan@sevanhirdavat.com

web: www.sevanhirdavat.com.tr
www.sevanhirdavatcilik.com
www.kawasakiturkiye.com
www.hymairturkiye.com
www.betaturkiye.net

KARAKÖY / İSTANBUL



* Güncel listeye www.sevanhirdavat.com.tr internet adresinden ulaşabilirsiniz.
* Hatalı yazım ve baskıdan kaynaklanan hatalar için işletmemiz sorumlu değildir.
* Listedeki fiyatlara KDV dahil değildir.

FIHRİST

A	A-AUST	Taş Düzeltme ve Elmaslı Mamuller	www.audia.at	208
	ALPHA	Sertmetal Parmak Frezeler ve Matkap Uçları		221
	AMERICAN TOOLS	El Aletleri	www.americantool.com	178
B	BAER	Klavuz,Pafta,Takım ve Kolları	www.voelkel.com	222
	BETA	El Aletleri	www.beta-tools.com	235
	BİTS UÇ VE ADAP.	Bits Uç ve Adaptörleri		185
	BRIT TORQUE	Tork Anahtarları	www.tw-tech.com.tw	198
C	CAROLUS	El Aletleri	www.gedore-werkzeugshop.de	188
	CERİN & MORRISFLEX	Kalıpçı Frezeler		201
D	DICK	El Aletleri	www.dick.de	182
E	EASTMAN	El Aletleri		192
	ELEPHANT	Mandrenler ve Döner Puntalar		194
	ENDO	Balanserler	www.endo-kogyo.co.jp	103
F	FUJI	Havalı Aletler	www.fujitools.com	24
G	GENIUS	Lokma Anahtar ve Aparatları	www.geniustools.net	112
H	HAZET	El Aletleri	www.hazet.de	190
	HUNGER	Ayarlı Raybalar	www.ludwig-hunger.de	204
	HYMAIR	Havalı Aletler	www.steedtools.com	88
K	KAWASAKİ	Havalı Aletler	www.kawasaki-mac.co.jp	1
	KUKKO	El Aletleri ve Çektirmeler	www.kukko.com	153
L	LASER	El Aletleri	www.lasertools.co.uk	188
M	MATKAP UÇLU VİDA	Matkap Uçlu Vida		188
O	OSG	Parmak Frezeler	www.osg.co.jp	206
	OTOMATİK KAFA VE TARAK	Otomatik Pafta Kafa ve Tarakları		206
P	PCL	Hava Saati	www.pclairtechnology.com	108
R	RECORD	Boru Anahtarları		190
	SERVİSLER	Tamir ve Bakım servisleri		237
	SH	Havalı Aletler		86
S	SIMPLEX	Cırcırlı Vagon Krikoları	www.tksimplex.com	196
	SUNTECH	Havalı Aletler	www.sunmatch.com	39
	TORNADOR	Havalı Temizlik Tabancası		110
T	TURNUS	El Aletleri	www.kukko.com	174
U	UHT	Havalı Aletler	www.uht.co.jp	106
W	WOCARB	Sertmetal Mamuller	www.wolframcarb.com	211

KAWASAKI Professional Air Tools

Made in Japan

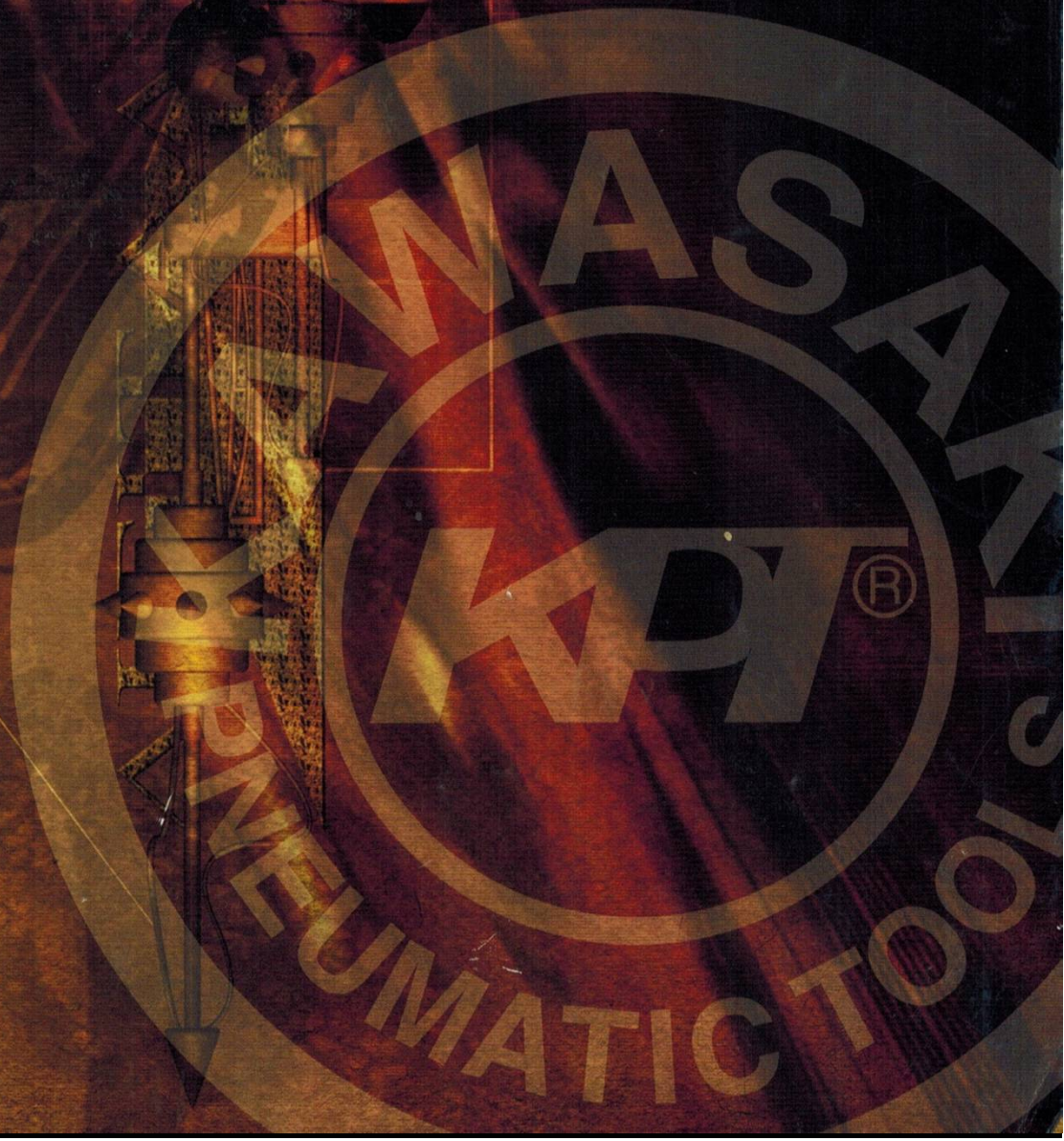

KAWASAKI

3/8" KELEBEK SOMUN SIKMA-SÖKME



Soket	3/8"
Max.Torku	12,50kg/m
Ağırlığı	0,90 Kg
Uzunluğu	177mm
Devir	12500d/dk
Çekiç Sistemi	Tek çekiç
Hava Girişi	1/4"

KPT-12WX

\$205,00

3/8" KELEBEK SOMUN SIKMA-SÖKME



Soket	3/8"
Max.Torku	7,00kg/m
Ağırlığı	0,46 Kg
Uzunluğu	137mm
Devir	10000d/dk
Çekiç Sistemi	Çift çekiç
Hava Girişi	1/4"

KPT-12BB

\$205,00

3/8" KABZALI SOMUN SIKMA-SÖKME



Soket	3/8"
Max.Torku	12,00kg/m
Ağırlığı	1,30 Kg
Uzunluğu	138mm
Devir	12000d/dk
Çekiç Sistemi	Tek çekiç
Hava Girişi	1/4"

KPT-12W

\$214,00

3/8" KABZALI SOMUN SIKMA-SÖKME



Soket	3/8"
Max.Torku	31,00kg/m
Ağırlığı	1,40 Kg
Uzunluğu	173mm
Devir	7500d/dk
Çekiç Sistemi	İkiz gözlük ç.
Hava Girişi	1/4"

COMPOSITE

KPT-12CE

\$275,00

1/2" KABZALI SOMUN SIKMA-SÖKME



Soket	1/2"
Max.Torku	50,00kg/m
Ağırlığı	2,50 Kg
Uzunluğu	190mm
Devir	5200d/dk
Çekiç Sistemi	Darbe pimli
Hava Girişi	1/4"

KPT-14SH

\$203,00

1/2" KABZALI SOMUN SIKMA-SÖKME



Soket	1/2"
Max.Torku	57,00kg/m
Ağırlığı	2,50 Kg
Uzunluğu	195mm
Devir	6300d/dk
Çekiç Sistemi	İkiz gözlük ç.
Hava Girişi	1/4"

KPT-231

\$226,00

KAWASAKI

1/2" KABZALI SOMUN SIKMA-SÖKME



Soket	1/2"
Max.Torku	56,00kg/m
Ağırlığı	2,10 Kg
Uzunluğu	185mm
Devir	6000d/dk
Çekiç Sistemi	İkiz gözlük ç.
Hava Girişi	1/4"

COMPOSITE

KPT-14ME

\$359,00

3/4" KABZALI SOMUN SIKMA-SÖKME



Soket	3/4"
Max.Torku	129,00kg/m
Ağırlığı	5,40 Kg
Uzunluğu	280mm
Devir	4600d/dk
Çekiç Sistemi	Darbe pimli
Hava Girişi	1/4"

KPT-1460

\$550,00

3/4" KABZALI SOMUN SIKMA-SÖKME



Soket	3/4" -Kısa
Max.Torku	75,00kg/m
Ağırlığı	4,80 Kg
Uzunluğu	245mm
Devir	5900d/dk
Çekiç Sistemi	Tek çekiç
Hava Girişi	1/4"

KPT-220P

\$399,00

Soket	3/4" -Uzun
Max.Torku	75,00kg/m
Ağırlığı	5,30 Kg
Uzunluğu	400mm
Devir	5900d/dk
Çekiç Sistemi	Tek çekiç
Hava Girişi	1/4"

KPT-220PL

\$450,00

1" KABZALI SOMUN SIKMA-SÖKME



Soket	1" -Kısa
Max.Torku	200,00kg/m
Ağırlığı	9,50 Kg
Uzunluğu	266mm
Devir	4300d/dk
Çekiç Sistemi	Tek çekiç
Hava Girişi	3/8"

KPT-321P

\$836,00

Soket	1" -Uzun
Max.Torku	200,00kg/m
Ağırlığı	11,50 Kg
Uzunluğu	432mm
Devir	4300d/dk
Çekiç Sistemi	Tek çekiç
Hava Girişi	3/8"

KPT-321PL

\$836,00

1" KABZALI SOMUN SIKMA-SÖKME



Soket	1" -Kısa
Max.Torku	235,00kg/m
Ağırlığı	10,90 Kg
Uzunluğu	285mm
Devir	4700d/dk
Çekiç Sistemi	Pimli çekiç
Hava Girişi	1/2"

KPT-421P

\$880,00

Soket	1" -Uzun
Max.Torku	235,00kg/m
Ağırlığı	12,40 Kg
Uzunluğu	451mm
Devir	4700d/dk
Çekiç Sistemi	Pimli çekiç
Hava Girişi	1/2"

KPT-421PL

\$880,00

1" KABZALI SOMUN SIKMA-SÖKME



Soket	1" -Kısa
Max.Torku	310,00kg/m
Ağırlığı	14,20 Kg
Uzunluğu	322mm
Devir	2900d/dk
Çekiç Sistemi	Pimli çekiç
Hava Girişi	3/8"

KPT-452P

\$1.430,00

Soket	1" -Uzun
Max.Torku	310,00kg/m
Ağırlığı	16,20 Kg
Uzunluğu	510mm
Devir	2900d/dk
Çekiç Sistemi	Pimli çekiç
Hava Girişi	3/8"

KPT-452PL

\$1.430,00

1" DÜZ TİP SOMUN SIKMA-SÖKME



Soket	1" -Kısa
Max.Torku	320,00kg/m
Ağırlığı	15,10 Kg
Uzunluğu	444mm
Devir	3200d/dk
Çekiç Sistemi	Tek çekiç
Hava Girişi	1/2"

KPT-450S

\$1.430,00

Soket	1" -Uzun
Max.Torku	320,00kg/m
Ağırlığı	17,10 Kg
Uzunluğu	632mm
Devir	3200d/dk
Çekiç Sistemi	Tek çekiç
Hava Girişi	1/2"

KPT-450SL

\$1.430,00

1.1/2" DÜZ TİP SOMUN SIKMA-SÖKME



Soket	1.1/2"
Max.Torku	550,00kg/m
Ağırlığı	18,10 Kg
Uzunluğu	553mm
Devir	3000d/dk
Çekiç Sistemi	Darbe pimli
Hava Girişi	1/2"

KPT-55SA

\$2.420,00

DIŞİ CIRCIR



Uç Ölçüsü	8-10-12-14mm
Max.Torku	4,00kg/m
Ağırlığı	0,55 Kg
Uzunluğu	210mm
Devir	450d/dk
Hava Girişi	1/4"

KPT-20TR

\$399,00



Darbe pimli çekiç sistemi



Gözlük çekiç sistemi



Tek çekiç sistemi



Çift çekiç sistemi

3/8" DARBELİ CIRCIR



Soket	3/8"
Max.Torku	6,80kg/m
Ağırlığı	0,60 Kg
Uzunluğu	155mm
Devir	500d/dk
Çekiç Sistemi	Tek gözlük ç.
Hava Girişi	1/4"

KPT-625

\$330,00

1/4" CIRCIR



Soket	1/4"
Max.Torku	4,80kg/m
Ağırlığı	0,50 Kg
Uzunluğu	170mm
Devir	310d/dk
Hava Girişi	1/4"

KPT-705

\$194,00

3/8" - 1/2" CIRCIR



Soket	3/8"
Max.Torku	16,00kg/m
Ağırlığı	1,20 Kg
Uzunluğu	254mm
Devir	160d/dk
Hava Girişi	1/4"

KPT-1170

\$176,00

Soket	1/2"
Max.Torku	17,00kg/m
Ağırlığı	1,20 Kg
Uzunluğu	254mm
Devir	160d/dk
Hava Girişi	1/4"

KPT-1175

\$176,00

KAWASAKI

KABZALI TORNAVİDA



Uç Ölçüsü	1/4"
Kapasitesi	6mm
Çalışma Torku	0,50-1,50kgm
Ağırlığı	1,20 Kg
Uzunluğu	205mm
Devir	2200d/dk
Hava Girişi	1/4"

KPT-SD110

\$358,00

Uç Ölçüsü	1/4"
Kapasitesi	6mm
Çalışma Torku	0,50-1,50kgm
Ağırlığı	1,35 Kg
Uzunluğu	240mm
Devir	800d/dk
Hava Girişi	1/4"

KPT-SD150

\$464,00

KABZALI TORNAVİDA



Uç Ölçüsü	1/4"
Kapasitesi	6mm
Çalışma Torku	1,10-1,70kgm
Ağırlığı	1,35 Kg
Uzunluğu	205mm
Devir	2200d/dk
Hava Girişi	1/4"

KPT-SD110A

\$391,00

DÜZ TİP TORNAVİDA



Uç Ölçüsü	1/4"
Kapasitesi	4mm
Çalışma Torku	0,15-0,40kgm
Ağırlığı	1,20 Kg
Uzunluğu	203mm
Devir	1600d/dk
Hava Girişi	1/8"

KPT-SD140

\$464,00

DÜZ TİP TORNAVİDA



Uç Ölçüsü	1/4"
Kapasitesi	6mm
Çalışma Torku	0,50-1,50kgm
Ağırlığı	1,10 Kg
Uzunluğu	250mm
Devir	1800d/dk
Hava Girişi	1/4"

KPT-SD120

\$358,00

Uç Ölçüsü	1/4"
Kapasitesi	6mm
Çalışma Torku	0,50-1,50kgm
Ağırlığı	1,30 Kg
Uzunluğu	265mm
Devir	800d/dk
Hava Girişi	1/4"

KPT-SD160

\$464,00

KAWASAKI

10mm KABZALI MATKAP



Mandren	10mm
Dönüş	Sağ
Ağırlığı	0,75 Kg
Uzunluğu	170mm
Devir	2500d/dk
Hava Girişi	1/4"

KPT-63D

\$206,00

10mm KABZALI MATKAP



Mandren	10mm
Dönüş	Sağ
Ağırlığı	0,90 Kg
Uzunluğu	165mm
Devir	2400d/dk
Hava Girişi	1/4"

KPT-1655

\$237,00

10mm KABZALI MATKAP



Mandren	10mm
Dönüş	Sağ-Sol
Ağırlığı	1,20 Kg
Uzunluğu	195mm
Devir	2200d/dk
Hava Girişi	1/4"

KPT-68

\$315,00

10mm DÜZ TİP MATKAP



Mandren	10mm
Dönüş	Sağ
Ağırlığı	0,75 Kg
Uzunluğu	192mm
Devir	3800d/dk
Hava Girişi	1/4"

KPT-74B

\$296,00

10mm 90° MATKAP



Mandren	10mm
Dönüş	Sağ-Sol
Ağırlığı	1,00 Kg
Uzunluğu	208mm
Devir	1800d/dk
Hava Girişi	1/4"

KPT-64ADR

\$404,00

13mm KABZALI MATKAP



Mandren	13mm
Dönüş	Sağ
Ağırlığı	1,60 Kg
Uzunluğu	225mm
Devir	550d/dk
Hava Girişi	1/4"

KPT-1651

\$411,00

KAWASAKI

13mm KABZALI MATKAP



Mandren	13mm
Dönüş	Sağ-Sol
Ağırlığı	1,60 Kg
Uzunluğu	220mm
Devir	500d/dk
Hava Girişi	1/4"

KPT-71

\$460,00

13mm 90° MATKAP



Mandren	13mm
Dönüş	Sağ-Sol
Ağırlığı	1,20 Kg
Uzunluğu	208mm
Devir	450d/dk
Hava Girişi	1/4"

KPT-66ADR

\$444,00

KALIPÇI TAŞLAMA



Pens Ölçüsü	6mm(1/4")
Ağırlığı	0,40 Kg
Uzunluğu	120mm
Devir	25000d/dk
Egzost	Önden
Hava Girişi	1/4"

KPT-22DG

\$165,00

Pens Ölçüsü	6mm(1/4")
Ağırlığı	0,55 Kg
Uzunluğu	145mm
Devir	23000d/dk
Egzost	Önden
Hava Girişi	1/4"

KPT-24DG

\$197,00

KALIPÇI TAŞLAMA



Pens Ölçüsü	6mm(1/4")
Ağırlığı	0,40 Kg
Uzunluğu	160mm
Devir	32000d/dk
Egzost	Arkadan
Hava Girişi	1/4"

KPT-1220

\$193,00

Pens Ölçüsü	6mm(1/4")
Ağırlığı	0,65 Kg
Uzunluğu	164mm
Devir	21000d/dk
Egzost	Arkadan
Hava Girişi	1/4"

KPT-1240

\$214,00

KALIPÇI TAŞLAMA



Pens Ölçüsü	6mm(1/4")
Ağırlığı	0,41 Kg
Uzunluğu	153mm
Devir	23000d/dk
Egzost	Arkadan
Hava Girişi	1/4"

KPT-3200

\$194,00

KALIPÇI TAŞLAMA



Pens Ölçüsü	6mm(1/4")
Ağırlığı	0,73 Kg
Uzunluğu	192mm
Devir	3800d/dk
Egzost	Arkadan
Hava Girişi	1/4"

KPT-28DG

\$296,00

90° KALIPÇI TAŞLAMA



Pens Ölçüsü	6mm(1/4")
Ağırlığı	0,40 Kg
Uzunluğu	123mm
Devir	15000d/dk
Egzost	Önden
Hava Girişi	1/4"

KPT-26DG

\$296,00

90° KALIPÇI TAŞLAMA



Pens Ölçüsü	6mm(1/4")
Ağırlığı	0,55 Kg
Uzunluğu	160mm
Devir	20000d/dk
Egzost	Arkadan
Hava Girişi	1/4"

KPT-3210

\$296,00

120° KALIPÇI TAŞLAMA



Pens Ölçüsü	6mm(1/4")
Ağırlığı	0,56 Kg
Uzunluğu	194mm
Devir	20000d/dk
Egzost	Arkadan
Hava Girişi	1/4"

KPT-3220

\$302,00

AĞIR HİZMET KALIPÇI TAŞLAMA



Pens Ölçüsü	6mm(1/4")
Ağırlığı	0,70 Kg
Uzunluğu	300mm
Devir	24000d/dk
Egzost	Arkadan
Hava Girişi	1/4"

KPT-NG25L-CR

\$660,00

AĞIR HİZMET KALIPÇI TAŞLAMA



Pens Ölçüsü	6mm(1/4")
Ağırlığı	0,70 Kg
Uzunluğu	167mm
Devir	20000d/dk
Egzost	Arkadan
Hava Girişi	3/8"

**KPT-
NG45A-CR**

\$420,00

AĞIR HİZMET KALIPÇI TAŞLAMA



Pens Ölçüsü	6mm(1/4")
Ağırlığı	1,20 Kg
Uzunluğu	310mm
Devir	16000d/dk
Egzost	Arkadan
Hava Girişi	3/8"

**KPT-
NG65A-CR**

\$594,00



Pens Ölçüsü	6mm(1/4")
Ağırlığı	1,40 Kg
Uzunluğu	370mm
Devir	16000d/dk
Egzost	Arkadan
Hava Girişi	3/8"

**KPT-
NG65L-CR**

\$744,00

AĞIR HİZMET KALIPÇI TAŞLAMA



Pens Ölçüsü	6mm(1/4")
Ağırlığı	1,30 Kg
Uzunluğu	365mm
Devir	16000d/dk
Egzost	Arkadan
Hava Girişi	3/8"

**KPT-
NG65A-CS**

\$594,00



Pens Ölçüsü	6mm(1/4")
Ağırlığı	1,40 Kg
Uzunluğu	425mm
Devir	16000d/dk
Egzost	Arkadan
Hava Girişi	3/8"

**KPT-
NG65L-CS**

\$744,00

AĞIR HİZMET KALIPÇI TAŞLAMA



Pens Ölçüsü	6mm(1/4")
Ağırlığı	1,40 Kg
Uzunluğu	310mm
Devir	15000d/dk
Egzost	Arkadan
Hava Girişi	3/8"

**KPT-
NG75A-CR**

\$717,00



Pens Ölçüsü	6mm(1/4")
Ağırlığı	2,40 Kg
Uzunluğu	515mm
Devir	15000d/dk
Egzost	Arkadan
Hava Girişi	3/8"

**KPT-
NG75L-CR**

\$975,00

KAWASAKI

AĞIR HİZMET KALIPÇI TAŞLAMA



Pens Ölçüsü	6mm(1/4")
Ağırlığı	1,40 Kg
Uzunluğu	365mm
Devir	15000d/dk
Egzost	Arkadan
Hava Girişi	3/8"

**KPT-
NG75A-CS**
\$717,00



Pens Ölçüsü	6mm(1/4")
Ağırlığı	2,40 Kg
Uzunluğu	570mm
Devir	15000d/dk
Egzost	Arkadan
Hava Girişi	3/8"

**KPT-
NG75L-CS**
\$975,00

YATAY TİP SATIŞ TAŞLAMA



Taş Çapı	65mm
Diş Ölçüsü	3/8x16BSW
Ağırlığı	1,30 Kg
Uzunluğu	220mm
Devir	16000d/dk
Hava Girişi	3/8"

**KPT-
NG65A-DR**
\$634,00

Taş Çapı	75mm
Diş Ölçüsü	3/8x16BSW
Ağırlığı	1,50 Kg
Uzunluğu	280mm
Devir	15000d/dk
Hava Girişi	3/8"

**KPT-
NG75A-DR**
\$669,00

Taş Çapı	125mm
Diş Ölçüsü	1/2x12BSW
Ağırlığı	3,10 Kg
Uzunluğu	395mm
Devir	13000d/dk
Hava Girişi	1/2"

**KPT-
NG125A-DR**
\$1.058,00

Taş Çapı	150mm
Diş Ölçüsü	5/8x11BSW
Ağırlığı	4,40 Kg
Uzunluğu	445mm
Devir	10000d/dk
Hava Girişi	1/2"

**KPT-
NG150A-DR**
\$1.149,00

100mm SATIŞ TAŞLAMA



Taş Çapı	100mm
Diş Ölçüsü	m10x1,5
Ağırlığı	1,70 Kg
Uzunluğu	229mm
Devir	12000d/dk
Hava Girişi	1/4"

KPT-100AL
\$510,00

100mm SATIŞ TAŞLAMA



Taş Çapı	100mm
Diş Ölçüsü	m10x1,5
Ağırlığı	0,90 Kg
Uzunluğu	195mm
Devir	12000d/dk
Hava Girişi	1/4"

KPT-104
\$560,00

125mm SATIH TAŞLAMA



Taş Çapı	125mm
Diş Ölçüsü	m14x2
Ağırlığı	1,70 Kg
Uzunluğu	229mm
Devir	12000d/dk
Hava Girişi	1/4"

KPT-126

\$538,00

180mm SATIH TAŞLAMA



Taş Çapı	180mm
Diş Ölçüsü	m14x2
Ağırlığı	3,60 Kg
Uzunluğu	270mm
Devir	7500d/dk
Hava Girişi	3/8"

KPT-183

\$612,00

180mm SATIH TAŞLAMA



Taş Çapı	180mm
Diş Ölçüsü	m14x2
Ağırlığı	3,50 Kg
Uzunluğu	320mm
Devir	7500d/dk
Hava Girişi	3/8"

KPT-184

\$612,00

230mm SATIH TAŞLAMA



Taş Çapı	230mm
Diş Ölçüsü	5/8x11BSW
Ağırlığı	4,80 Kg
Uzunluğu	310mm
Devir	5900d/dk
Hava Girişi	1/2"

KPT-NAS 9B

\$1.375,00

180mm DİK TİP POLİSAJ



Disk Çapı	180mm
Diş Ölçüsü	5/8x11BSW
Ağırlığı	2,10 Kg
Uzunluğu	192mm
Devir	2500d/dk
Hava Girişi	1/4"

KPT-36P

\$538,00

180mm YATAY TİP POLİSAJ



Disk Çapı	180mm
Diş Ölçüsü	5/8x11BSW
Ağırlığı	2,40 Kg
Uzunluğu	406mm
Devir	3800d/dk
Hava Girişi	1/4"

KPT-37P

\$538,00

125mm DİK TİP POLİSAJ



Disk Çapı	125mm
Diş Ölçüsü	5/16x24UNF
Ağırlığı	1,20 Kg
Uzunluğu	234mm
Devir	3000d/dk
Hava Girişi	1/4"

KPT-425K

\$814,00

45/72mm POLİSAJ & ZIMPARA



Disk Çapı	45+72mm
Diş Ölçüsü	5/16x24UNF
Ağırlığı	0,90 Kg
Uzunluğu	185mm
Devir	5000d/dk
Hava Girişi	1/4"

KPT-430K

\$787,00

180mm DİK TİP DAİRESEL ZIMPARA



Disk Çapı	180mm
Diş Ölçüsü	5/8x11BSW
Ağırlığı	2,10 Kg
Uzunluğu	192mm
Devir	5200d/dk
Hava Girişi	1/4"

KPT-34S

\$538,00

180mm YATAY TİP DAİRESEL ZIMPARA



Disk Çapı	180mm
Diş Ölçüsü	5/8x11BSW
Ağırlığı	2,40 Kg
Uzunluğu	406mm
Devir	5400d/dk
Hava Girişi	1/4"

KPT-38S

\$533,00

50mm EKSANTRİK POLİSAJ & ZIMPARA



Disk Çapı/Eksan.	50mm / 3mm
Diş Ölçüsü	5/16x24UNF
Ağırlığı	0,70 Kg
Uzunluğu	208mm
Devir	10000d/dk
Hava Girişi	1/4"

KPT-165DA

\$499,00

150mm EKSANTRİK DAİRESEL ZIMPARA



Disk Çapı/Eksan.	150mm / 5mm
Diş Ölçüsü	5/16x24UNF
Ağırlığı	0,90 Kg
Uzunluğu	188mm
Devir	10000d/dk
Hava Girişi	1/4"

KPT-3500

\$436,00

150mm EKSANTRİK DAİRESEL ZIMPARA



Disk Çapı/Eksan.	150mm / 10mm
Diş Ölçüsü	5/16x24UNF
Ağırlığı	1,50 Kg
Uzunluğu	253mm
Devir	10000d/dk
Hava Girişi	1/4"

KPT-160DA

\$519,00

Disk Çapı/Eksan.	150mm / 10mm
Diş Ölçüsü	5/16x24UNF
Ağırlığı	1,50 Kg
Uzunluğu	253mm
Devir	10000d/dk
Hava Girişi	1/4"

Toz Emişli

KPT-160DAF

\$659,00

150mm EKSANTRİK DAİRESEL ZIMPARA



Disk Çapı/Eksan.	150mm / 7mm
Diş Ölçüsü	5/16x24UNF
Ağırlığı	1,50 Kg
Uzunluğu	253mm
Devir	10000d/dk
Hava Girişi	1/4"

KPT-161DA

\$519,00

Disk Çapı/Eksan.	150mm / 7mm
Diş Ölçüsü	5/16x24UNF
Ağırlığı	1,50 Kg
Uzunluğu	253mm
Devir	10000d/dk
Hava Girişi	1/4"

Toz Emişli

KPT-161DAF

\$659,00

150mm EKSANTRİK DAİRESEL ZIMPARA



Disk Çapı/Eksan.	150mm / 5mm
Diş Ölçüsü	5/16x24UNF
Ağırlığı	1,50 Kg
Uzunluğu	253mm
Devir	10000d/dk
Hava Girişi	1/4"

KPT-162DA

\$569,00

Disk Çapı/Eksan.	150mm / 5mm
Diş Ölçüsü	5/16x24UNF
Ağırlığı	1,50 Kg
Uzunluğu	253mm
Devir	10000d/dk
Hava Girişi	1/4"

Toz Emişli

KPT-162DAF

\$702,00

150mm EKSANTRİK DAİRESEL ZIMPARA



Disk Çapı/Eksan.	150mm / 5mm
Diş Ölçüsü	5/16x24UNF
Ağırlığı	1,00 Kg
Uzunluğu	228mm
Devir	10000d/dk
Hava Girişi	1/4"

Toz Emişli

KPT-1320F

\$460,00

150mm EKSANTRİK DAİRESEL ZIMPARA



Disk Çapı/Eksan.	150mm / 5mm
Diş Ölçüsü	5/16x24UNF
Ağırlığı	0,95 Kg
Uzunluğu	171mm
Devir	9000d/dk
Hava Girişi	1/4"

KPT-166DA

\$538,00

Disk Çapı/Eksan.	150mm / 5mm
Diş Ölçüsü	5/16x24UNF
Ağırlığı	0,95 Kg
Uzunluğu	171mm
Devir	9000d/dk
Hava Girişi	1/4"

Toz Emişli

KPT-166DAF

\$599,00

150mm EKSANTRİK DAİRESEL ZIMPARA



Disk Çapı/Eksan.	150mm / 5mm
Diş Ölçüsü	5/16x24UNF
Ağırlığı	1,00 Kg
Uzunluğu	168mm
Devir	9500d/dk
Hava Girişi	1/4"

KPT-1325

\$442,00

Disk Çapı/Eksan.	150mm / 5mm
Diş Ölçüsü	5/16x24UNF
Ağırlığı	1,00 Kg
Uzunluğu	168mm
Devir	9500d/dk
Hava Girişi	1/4"

Toz Emişli

KPT-1325F

\$484,00

RENDE ZIMPARA



Taban Ölçüsü	75x400mm
Strok	25mm
Ağırlığı	2,90 Kg
Uzunluğu	400mm
Devir	2000d/dk
Hava Girişi	1/4"

KPT-44SL

\$454,00

SULU TİP EKSANTRİK TİTREŞİMLİ ZIMPARA

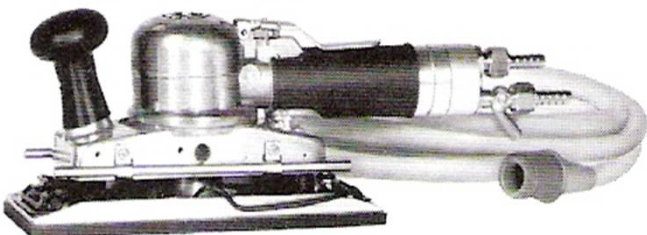

Taban Ölçüsü	112x220mm
Eksantrik	5mm
Ağırlığı	2,30 Kg
Uzunluğu	284mm
Devir	6500d/dk
Hava Girişi	1/4"

KPT-175

\$874,00

EKSANTRİK TİREŞİMLİ ZIMPARA

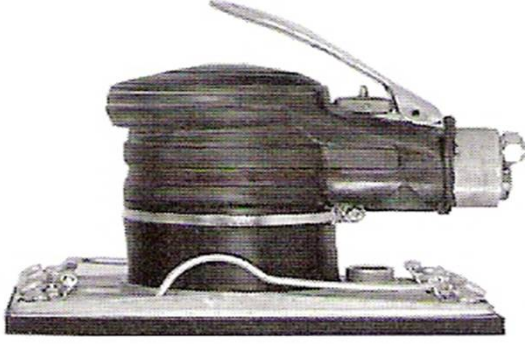

Taban Ölçüsü	93x175mm
Eksantrik	5mm
Ağırlığı	1,90 Kg
Uzunluğu	250mm
Devir	8600d/dk
Hava Girişi	1/4"

KPT-90S

\$329,00

Taban Ölçüsü	93x175mm
Eksantrik	5mm
Ağırlığı	1,90 Kg
Uzunluğu	250mm
Devir	8600d/dk
Hava Girişi	1/4"

Toz Emişli

KPT-90D

\$378,00

EKSANTRİK TİREŞİMLİ ZIMPARA



Taban Ölçüsü	73x145mm
Eksantrik	5mm
Ağırlığı	1,20 Kg
Uzunluğu	160mm
Devir	8000d/dk
Hava Girişi	1/4"

KPT-174

\$521,00

Taban Ölçüsü	73x145mm
Eksantrik	5mm
Ağırlığı	1,20 Kg
Uzunluğu	160mm
Devir	8000d/dk
Hava Girişi	1/4"

Toz Emişli

KPT-174F

\$642,00

CIRTLI ZIMPARA TAKOZU



Taban Ölçüsü	70x235mm
--------------	----------

KPT-2030C

\$218,00

Taban Ölçüsü	70x235mm
--------------	----------

Toz Emişli

KPT-2030S

\$303,00

BANT ZIMPARA



Bant Ölçüsü	10x330mm
Ağırlığı	0,80 Kg
Uzunluğu	275mm
Devir	16000d/dk
Hava Girişi	1/4"

KPT-370

\$418,00

BANT ZIMPARA



Bant Ölçüsü	20x520mm
Ağırlığı	1,40 Kg
Uzunluğu	365mm
Devir	17000d/dk
Hava Girişi	1/4"

KPT-520

\$462,00

POP PERÇİN MAKİNESİ



Kapasitesi	2,4-6,4mm
Ağırlığı	2,10 Kg
Uzunluğu	260mm
Hava Girişi	3/8"

KPT-516H

\$1.130,00

Kapasitesi	2,4-4,8mm
Ağırlığı	1,50 Kg
Uzunluğu	229mm
Hava Girişi	3/8"

KPT-517H

\$825,00

VAKUMLU POP PERÇİN MAKİNESİ



Kapasitesi	2,4-6,4mm
Ağırlığı	2,40 Kg
Uzunluğu	260mm
Hava Girişi	3/8"

KPT-516HS

\$1.791,00

Kapasitesi	2,4-4,8mm
Ağırlığı	1,70 Kg
Uzunluğu	229mm
Hava Girişi	3/8"

KPT-517HS

\$1.301,00

KAYNAK AĞZI AÇMA



Asgari Çap	6,8mm
Havşa Kırma Kap.	1,5mm
Ağırlığı	0,40 Kg
Uzunluğu	112mm
Devir	23000d/dk
Hava Girişi	1/4"

KPT-2302

\$575,00

TESTERE



Kesme Kapasitesi	1,5mm
Piston Stroku	9,00mm
Devir	5000d/dk
Ağırlığı	0,90 Kg
Uzunluğu	278mm
Hava Girişi	1/4"

KPT-1100

\$714,00

TESTERE



Kesme Kapasitesi	1,5mm
Piston Stroku	8,70mm
Devir	11000d/dk
Ağırlığı	0,50 Kg
Uzunluğu	250mm
Hava Girişi	1/4"

KPT-720

\$455,00

TESTERE



Kesme Kapasitesi	3mm
Piston Stroku	12,00mm
Devir	5300d/dk
Ağırlığı	0,60 Kg
Uzunluğu	207mm
Hava Girişi	1/4"

KPT-730

\$363,00

NİBLER SAC MAKASI



Kesme Kapasitesi	2mm Alüminyum 2mm Hafif çelik
Devir	3800d/dk
Ağırlığı	1,00 Kg
Uzunluğu	181mm
Hava Girişi	1/4"

KPT-80

\$538,00

ÇEKİÇ - KESKİ



Piston Çapı	19mm
Piston Stroku	55mm
Vuruş Adedi	3000bpm
Ağırlığı	1,65 Kg
Uzunluğu	216mm
Hava Girişi	1/4"

KPT-52K

\$300,00

ÇEKİÇ - KESKİ



Piston Çapı	20mm
Piston Stroku	12mm
Vuruş Adedi	5000bpm
Ağırlığı	0,90 Kg
Uzunluğu	175mm
Hava Girişi	1/4"

KPT-F1

\$299,00

ÇEKİÇ - KESKİ



Piston Çapı	22mm
Piston Stroku	22mm
Vuruş Adedi	4000bpm
Ağırlığı	1,10 Kg
Uzunluğu	187mm
Hava Girişi	1/4"

KPT-F2

\$356,00

ÇEKİÇ - KESKİ



Piston Çapı	20mm
Piston Stroku	12mm
Vuruş Adedi	4000bpm
Ağırlığı	1,80 Kg
Uzunluğu	198mm
Hava Girişi	1/4"

KPT-F3

\$365,00

ÇEKİÇ - KESKİ - İĞNELİ KESKİ



Piston Çapı	25mm
Piston Stroku	22mm
İğne Ölçü/Adedi	3mm/13 Ad.
Vuruş Adedi	4000bpm
Ağırlığı	2,70 Kg
Uzunluğu	232mm
Hava Girişi	1/4"

KPT-F4

\$511,00

ÇEKİÇ - KESKİ



Piston Çapı	20mm
Piston Stroku	12mm
Vuruş Adedi	4000bpm
Ağırlığı	2,70 Kg
Uzunluğu	395198mm
Hava Girişi	1/4"

KPT-F5

\$365,00

ÇEKİÇ - KESKİ - İĞNELİ KESKİ



Piston Çapı	25mm
Piston Stroku	22mm
İğne Ölçü/Adedi	3mm/19 Ad.
Vuruş Adedi	4000bpm
Ağırlığı	2,60 Kg
Uzunluğu	410mm
Hava Girişi	1/4"

KPT-F6

\$511,00

JUMBO ISKARPELA



Piston apı	25mm
Piston Stroku	22mm
Vuruş Adedi	4000bpm
Ağırlığı	3,00 Kg
Uzunluęu	750mm
Hava Girişı	3/8"

KPT-J5

\$1.320,00

"S" TİPİ RASPA



Piston apı	30x24x80mm
Piston Stroku	25mm
Vuruş Adedi	800bpm
Ağırlığı	2,30 Kg
Uzunluęu	480mm
Hava Girişı	3/8"

KPT-S2

\$588,00

BETON KIRICILAR



Piston apı	35mm
Piston Stroku	102mm
Vuruş Adedi	1700bpm
Ağırlığı	13,00 Kg
Uzunluęu	470mm
Hava Girişı	1"
Hortum apı	19mm

KPT-CB10

\$1.286,00

Piston apı	40mm
Piston Stroku	165mm
Vuruş Adedi	900bpm
Ağırlığı	21,00 Kg
Uzunluęu	565mm
Hava Girişı	1"
Hortum apı	19mm

KPT-CB20

\$1.491,00

Piston apı	45mm
Piston Stroku	165mm
Vuruş Adedi	850bpm
Ağırlığı	29,00 Kg
Uzunluęu	595mm
Hava Girişı	1"
Hortum apı	19mm

KPT-CB30

\$1.603,00

Piston apı	45mm
Piston Stroku	200mm
Vuruş Adedi	800bpm
Ağırlığı	32,50 Kg
Uzunluęu	660mm
Hava Girişı	1"
Hortum apı	19mm

KPT-CB35

\$2.087,00

PERÇİN ÇEKİÇLERİ



Piston Çapı	20mm
Piston Stroku	45mm
Vuruş Adedi	3000bpm
Ağırlığı	2,60 Kg
Uzunluğu	246mm
Hava Girişi	3/8"
Hortum Çapı	9,5mm

KPT-NC0S

\$753,00

Piston Çapı	28,5mm
Piston Stroku	26mm
Vuruş Adedi	3000bpm
Ağırlığı	5,50 Kg
Uzunluğu	355mm
Hava Girişi	3/8"
Hortum Çapı	12,7mm

KPT-NC1S

\$951,00

Piston Çapı	28,5mm
Piston Stroku	51mm
Vuruş Adedi	2600bpm
Ağırlığı	6,20 Kg
Uzunluğu	375mm
Hava Girişi	3/8"
Hortum Çapı	12,7mm

KPT-NC2S

\$1.010,00

Piston Çapı	28,5mm
Piston Stroku	76mm
Vuruş Adedi	2300bpm
Ağırlığı	6,50 Kg
Uzunluğu	420mm
Hava Girişi	3/8"
Hortum Çapı	12,7mm

KPT-NC3S

\$1.030,00

PERÇİN ÇEKİÇLERİ



Piston Çapı	24mm
Piston Stroku	52mm
Vuruş Adedi	2800bpm
Ağırlığı	4,20 Kg
Uzunluğu	295mm
Hava Girişi	3/8"
Hortum Çapı	12,7mm

KPT-AA10A

\$951,00

Piston Çapı	28mm
Piston Stroku	55mm
Vuruş Adedi	2600bpm
Ağırlığı	5,70 Kg
Uzunluğu	315mm
Hava Girişi	3/8"
Hortum Çapı	12,7mm

KPT-AA20A

\$1.030,00

Piston Çapı	28mm
Piston Stroku	79mm
Vuruş Adedi	2200bpm
Ağırlığı	6,20 Kg
Uzunluğu	345mm
Hava Girişi	3/8"
Hortum Çapı	12,7mm

KPT-AA30A

\$1.070,00

KAWASAKI

DÖKÜMCÜ TOKMAKLARI (KUM SIKIŞTIRMA)



Mil Çapı-Strok	18mm-50mm
Ağırlığı	2,00 Kg
Uzunluğu	430-230mm
Vuruş Adedi	1800bpm
Tokmak Ucu	40mm-Plastik
Hava Girişi	3/8"

KPT-1

\$713,00

Mil Çapı-Strok	18mm-50mm
Ağırlığı	3,00 Kg
Uzunluğu	940-740mm
Vuruş Adedi	1800bpm
Tokmak Ucu	40mm-Plastik
Hava Girişi	3/8"

KPT-1L

\$770,00

Mil Çapı-Strok	22mm-65mm
Ağırlığı	3,00 Kg
Uzunluğu	470-277mm
Vuruş Adedi	1000bpm
Tokmak Ucu	52mm-Plastik
Hava Girişi	3/8"

KPT-2

\$754,00

Mil Çapı-Strok	22mm-65mm
Ağırlığı	4,00 Kg
Uzunluğu	989-796mm
Vuruş Adedi	1000bpm
Tokmak Ucu	52mm-Plastik
Hava Girişi	3/8"

KPT-2L

\$792,00

Mil Çapı-Strok	25,4mm-100mm
Ağırlığı	6,00 Kg
Uzunluğu	619-400mm
Vuruş Adedi	800bpm
Tokmak Ucu	67mm-Plastik
Hava Girişi	3/8"

KPT-3

\$1.149,00

Mil Çapı-Strok	25,4mm-100mm
Ağırlığı	8,00 Kg
Uzunluğu	1165-946mm
Vuruş Adedi	800bpm
Tokmak Ucu	67mm-Plastik
Hava Girişi	1/2"

KPT-4

\$1.188,00

Mil Çapı-Strok	32mm-127mm
Ağırlığı	9,40 Kg
Uzunluğu	1300-987mm
Vuruş Adedi	700bpm
Tokmak Ucu	75mm-Plastik
Hava Girişi	1/2"

KPT-5

\$1.268,00

Mil Çapı-Strok	38mm-152mm
Ağırlığı	14,00 Kg
Uzunluğu	1330-1013mm
Vuruş Adedi	600bpm
Tokmak Ucu	130mm-Çelik
Hava Girişi	1/2"

KPT-6

\$2.693,00

Mil Çapı-Strok	42mm-152mm
Ağırlığı	16,00 Kg
Uzunluğu	1335-1035mm
Vuruş Adedi	600bpm
Tokmak Ucu	155mm-Çelik
Hava Girişi	1/2"

KPT-7

\$2.772,00

KUİK-KAPLİN GÖVDE

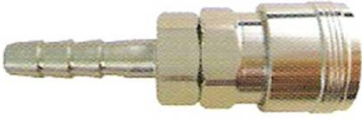

22-DSH	1/4"-9mm
23-DSH	3/8"-11mm
24-DSH	1/2"-15mm

GÖVDE-DSH

\$11,00

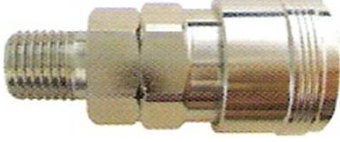

22-DSM	1/4"
23-DSM	3/8"
24-DSM	1/2"

GÖVDE-DSM

\$11,00



22-DSF	1/4"
23-DSF	3/8"
24-DSF	1/2"

GÖVDE-DSF

\$11,00

KUİK-KAPLİN RAKOR



22-DPH	1/4"-9mm
23-DPH	3/8"-11mm
24-DPH	1/2"-15mm

RAKOR-DPH

\$4,00



22-DPM	1/4"
23-DPM	3/8"
24-DPM	1/2"

RAKOR-DPM

\$4,00



22-DPF	1/4"
23-DPF	3/8"
24-DPF	1/2"

RAKOR-DPF

\$4,00

ÇEKİÇ - KESKİ YEDEK UÇLARI



F1 için

\$25,00

F2 için

\$27,00



AA10/20/30A için

\$55,00

NC0/1/2/3S için

\$55,00

CB10/20 için

\$70,00

F3-F4 için

\$32,00

CA7 için

\$70,00

CB30/35 için

\$80,00

ÇEKİÇ YEDEK UÇ TAKIMI



52K için

\$25,00

HAVALI ÇEKİÇ TUTUCU YAYI



52K için

\$10,00

HAVALI TESTERE YEDEĞİ



KPT-720/730 /1100 için

\$8,00

Fuji

POWER
AND PRECISION
IN PERFECT
HARMONY

INDUSTRIAL TOOLS

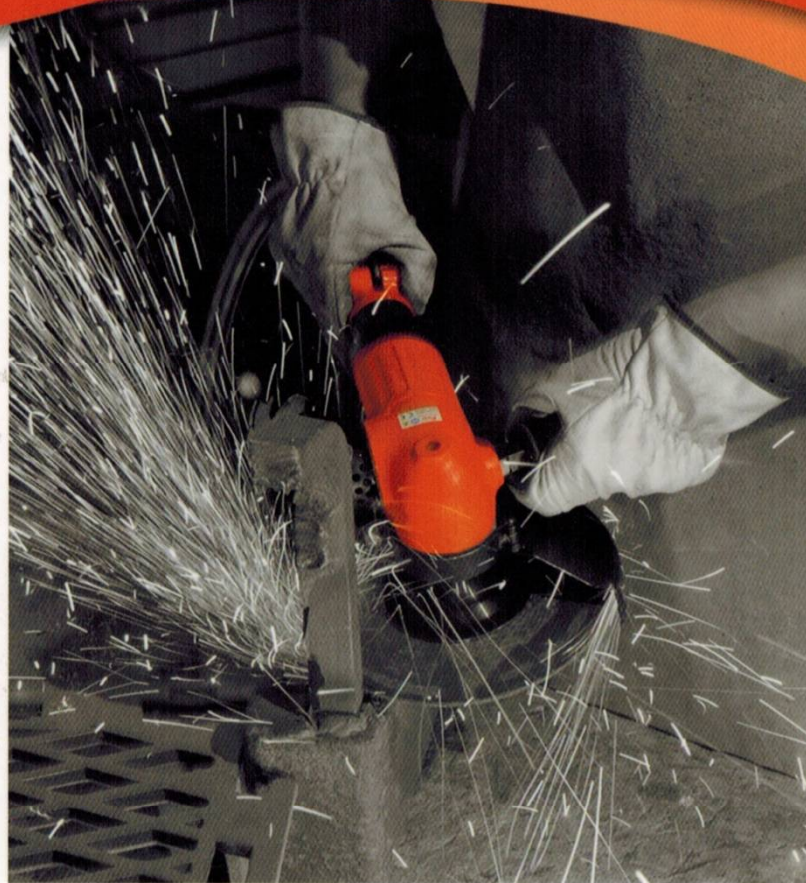

J A P A N E S E Q U A L I T Y S I N C E 1 9 4 3

SIKIŞTIRMALI (PULSE) MODEL SHUT-OFF KABZALI SOMUN SIKMA-SÖKMELER

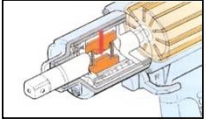

Soket	3/8"
Tork Aralığı	0,50-1,20kg/m
Ağırlığı	0,97 Kg
Uzunluğu	181mm
Devir	6200d/dk
Çekiç Sistemi	2 Bıçaklı Darbe Mekanizmalı
Hava girişi	1/4"

FLT-4-2

\$2.730,00

Soket	3/8"
Tork Aralığı	1,10-2,40kg/m
Ağırlığı	0,97 Kg
Uzunluğu	181mm
Devir	6500d/dk
Çekiç Sistemi	2 Bıçaklı Darbe Mekanizmalı
Hava girişi	1/4"

FLT-5-2

\$2.781,30

Soket	3/8"
Tork Aralığı	2,20-3,50kg/m
Ağırlığı	1,00 Kg
Uzunluğu	192mm
Devir	6300d/dk
Çekiç Sistemi	2 Bıçaklı Darbe Mekanizmalı
Hava girişi	1/4"

FLT-6-2

\$2.924,80

Soket	3/8"
Tork Aralığı	3,00-6,10kg/m
Ağırlığı	1,10 Kg
Uzunluğu	189,50mm
Devir	6100d/dk
Çekiç Sistemi	2 Bıçaklı Darbe Mekanizmalı
Hava girişi	1/4"

FLT-7-2

\$2.990,00

Soket	1/2"
Tork Aralığı	5,10-8,60kg/m
Ağırlığı	1,60 Kg
Uzunluğu	209mm
Devir	4800d/dk
Çekiç Sistemi	2 Bıçaklı Darbe Mekanizmalı
Hava girişi	1/4"

FLT-9-2

\$3.139,50

Soket	1/2"
Tork Aralığı	9,10-16,30kg/m
Ağırlığı	2,10 Kg
Uzunluğu	227,50mm
Devir	3400d/dk
Çekiç Sistemi	2 Bıçaklı Darbe Mekanizmalı
Hava girişi	1/4"

FLT-13-2

\$3.600,00

Soket	1/2"
Tork Aralığı	7,10-13,20kg/m
Ağırlığı	1,85 Kg
Uzunluğu	217,50mm
Devir	4500d/dk
Çekiç Sistemi	2 Bıçaklı Darbe Mekanizmalı
Hava girişi	1/4"

FLT-11-2

\$3.242,00

SIKIŞTIRMALI (PULSE) MODEL KABZALI SOMUN SIKMA-SÖKMELER

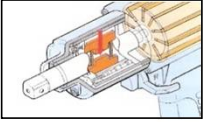

Soket	3/8"
Tork Aralığı	1,60-2,40kg/m
Ağırlığı	0,79 Kg
Uzunluğu	139,50mm
Devir	6700d/dk
Çekiç Sistemi	2 Bıçaklı Darbe Mekanizmalı
Hava girişi	1/4"

FL-4-1

\$2.100,00

Soket	3/8"
Tork Aralığı	2,00-4,00kg/m
Ağırlığı	0,79 Kg
Uzunluğu	139,50mm
Devir	6300d/dk
Çekiç Sistemi	2 Bıçaklı Darbe Mekanizmalı
Hava girişi	1/4"

FL-5-1

\$2.147,00

Soket	3/8"
Tork Aralığı	2,80-5,60kg/m
Ağırlığı	0,83 Kg
Uzunluğu	151,50mm
Devir	6700d/dk
Çekiç Sistemi	2 Bıçaklı Darbe Mekanizmalı
Hava girişi	1/4"

FL-6-1

\$2.192,00

Soket	3/8"
Tork Aralığı	3,40-6,10kg/m
Ağırlığı	1,02 Kg
Uzunluğu	155mm
Devir	6100d/dk
Çekiç Sistemi	2 Bıçaklı Darbe Mekanizmalı
Hava girişi	1/4"

FL-7-1

\$2.257,50

Soket	1/2"
Tork Aralığı	5,30-9,70kg/m
Ağırlığı	1,45 Kg
Uzunluğu	173mm
Devir	5000d/dk
Çekiç Sistemi	2 Bıçaklı Darbe Mekanizmalı
Hava girişi	1/4"

FL-9-1

\$2.415,00

Soket	1/2"
Tork Aralığı	12,20-17,50kg/m
Ağırlığı	2,10 Kg
Uzunluğu	192mm
Devir	3800d/dk
Çekiç Sistemi	2 Bıçaklı Darbe Mekanizmalı
Hava girişi	1/4"

FL-13-1

\$2.769,50

Soket	1/2"
Tork Aralığı	8,10-13,80kg/m
Ağırlığı	1,80 Kg
Uzunluğu	184mm
Devir	5000d/dk
Çekiç Sistemi	2 Bıçaklı Darbe Mekanizmalı
Hava girişi	1/4"

FL-11-1

\$2.493,80

SIKIŞTIRMALI (PULSE) MODEL SHUT-OFF DÜZ TİP SOMUN SIKMA-SÖKMELER

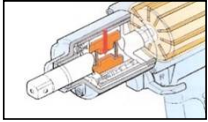

Soket	3/8"
Tork Aralığı	0,60-1,10kg/m
Ağırlığı	0,88 Kg
Uzunluğu	221mm
Devir	5500d/dk
Çekiç Sistemi	2 Bıçaklı Darbe Mekanizmalı
Hava girişi	1/4"

FLT-4S-1

\$2.730,00

Soket	3/8"
Tork Aralığı	1,10-2,00kg/m
Ağırlığı	0,88 Kg
Uzunluğu	221mm
Devir	6400d/dk
Çekiç Sistemi	2 Bıçaklı Darbe Mekanizmalı
Hava girişi	1/4"

FLT-5S-1

\$2.781,30

Soket	3/8"
Tork Aralığı	2,10-3,10kg/m
Ağırlığı	0,95 Kg
Uzunluğu	233,50mm
Devir	5800d/dk
Çekiç Sistemi	2 Bıçaklı Darbe Mekanizmalı
Hava girişi	1/4"

FLT-6S-1

\$2.924,80

SIKIŞTIRMALI (PULSE) MODEL DÜZ TİP SOMUN SIKMA-SÖKMELER

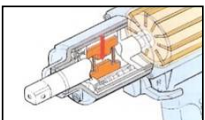

Soket	3/8"
Tork Aralığı	0,60-1,40kg/m
Ağırlığı	0,85 Kg
Uzunluğu	209mm
Devir	5600d/dk
Çekiç Sistemi	2 Bıçaklı Darbe Mekanizmalı
Hava girişi	1/4"

FL-4S-1

\$2.000,00

Soket	3/8"
Tork Aralığı	1,10-2,40kg/m
Ağırlığı	0,85 Kg
Uzunluğu	209mm
Devir	6300d/dk
Çekiç Sistemi	2 Bıçaklı Darbe Mekanizmalı
Hava girişi	1/4"

FL-5S-1

\$2.037,50

Soket	3/8"
Tork Aralığı	2,10-3,30kg/m
Ağırlığı	0,90 Kg
Uzunluğu	221mm
Devir	5600d/dk
Çekiç Sistemi	2 Bıçaklı Darbe Mekanizmalı
Hava girişi	1/4"

FL-6S-1

\$2.087,50

1/2" DÜZ TİP SOMUN SIKMA-SÖKME + 90° APARATI



Soket	1/2"
Max.Torku	19,00kg/m
Ağırlığı	3,00 Kg
Uzunluğu	356mm
Devir	6500d/dk
Çekiç Sistemi	Tek çekiç
Hava Girişi	1/4"

FW-14SX

\$1.144,50

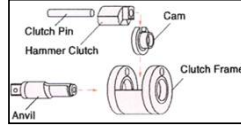

Soket	1/2"
Cinsi	90° Aparat
Uzunluğu	146mm

CA-14

\$745,30

1/2" KABZALI SOMUN SIKMA-SÖKME

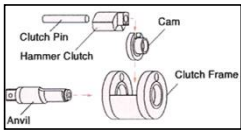

Soket	1/2"
Max.Torku	19,00kg/m
Ağırlığı	3,00 Kg
Uzunluğu	197mm
Devir	6500d/dk
Çekiç Sistemi	Tek çekiç
Hava Girişi	1/4"

FW-14PX-5

\$1.144,50

3/4" KABZALI SOMUN SIKMA-SÖKME

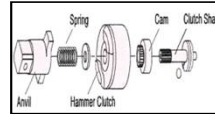
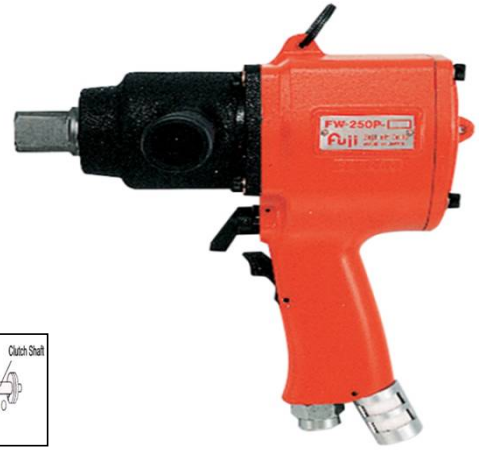

Soket	3/4"
Max.Torku	120,00kg/m
Ağırlığı	5,30 Kg
Uzunluğu	228mm
Devir	5000d/dk
Çekiç Sistemi	2 Çeneli tek çek.
Hava Girişi	3/8"

FW-250P-2

\$2.206,30

1" DÜZ TİP SOMUN SIKMA-SÖKME



Soket	1" -Kısa
Max.Torku	280,00kg/m
Ağırlığı	10,80 Kg
Uzunluğu	349mm
Devir	4500d/dk
Çekiç Sistemi	2 Çeneli tek çek.
Hava Girişi	1/2"

FW-420-1C

\$3.585,30

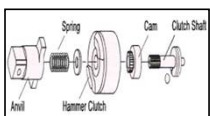

Soket	1" -Uzun
Max.Torku	280,00kg/m
Ağırlığı	12,50 Kg
Uzunluğu	501mm
Devir	4500d/dk
Çekiç Sistemi	2 Çeneli tek çek.
Hava Girişi	1/2"

FW-420-1CL

\$3.695,50

1" KABZALI SOMUN SIKMA-SÖKME

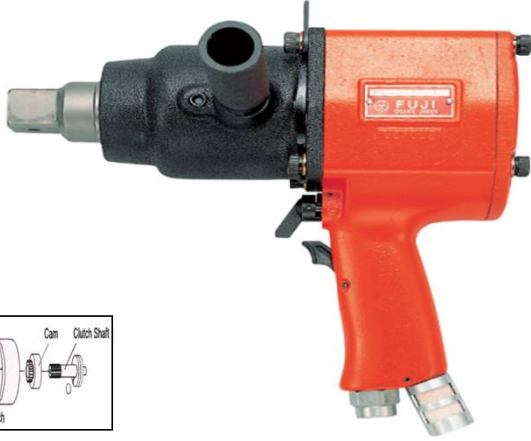

Soket	1"
Max.Torku	230,00kg/m
Ağırlığı	8,00 Kg
Uzunluğu	268mm
Devir	4800d/dk
Çekiş Sistemi	2 Çeneli tek çek.
Hava Girişi	3/8"

FW-320P-1

\$2.592,30

AÇIKAĞIZ CIRCIR



Uç Ölçüsü	10mm
Max.Torku	1,40kg/m
Ağırlığı	1,50 Kg
Uzunluğu	295mm
Devir	410d/dk
Hava Girişi	1/4"

FOW-10-1 10EC

\$3.347,50

Uç Ölçüsü	12mm
Max.Torku	1,90kg/m
Ağırlığı	1,60 Kg
Uzunluğu	306mm
Devir	300d/dk
Hava Girişi	1/4"

FOW-10-2 12EC

\$3.347,50

Uç Ölçüsü	13mm
Max.Torku	1,90kg/m
Ağırlığı	1,60 Kg
Uzunluğu	306mm
Devir	300d/dk
Hava Girişi	1/4"

FOW-10-2 13EC

\$3.347,50

Uç Ölçüsü	14mm
Max.Torku	1,90kg/m
Ağırlığı	1,60 Kg
Uzunluğu	306mm
Devir	300d/dk
Hava Girişi	1/4"

FOW-10-2 14EC

\$3.347,50

DIŞİ CIRCIR



Uç Ölçüsü	10mm
Max.Torku	1,10kg/m
Ağırlığı	1,20 Kg
Uzunluğu	316mm
Devir	200d/dk
Hava Girişi	1/4"

FRW-6NX-3A

\$1.851,50

Uç Ölçüsü	13mm
Max.Torku	1,30kg/m
Ağırlığı	1,20 Kg
Uzunluğu	320mm
Devir	170d/dk
Hava Girişi	1/4"

FRW-6NX-4A

\$1.863,00

Uç Ölçüsü	14mm
Max.Torku	3,00kg/m
Ağırlığı	2,20 Kg
Uzunluğu	378mm
Devir	200d/dk
Hava Girişi	1/4"

FRW-8NX-2

\$2.006,30

Uç Ölçüsü	13mm
Max.Torku	4,50kg/m
Ağırlığı	2,70 Kg
Uzunluğu	417mm
Devir	140d/dk
Hava Girişi	1/4"

FRW-10N-2 13EC

\$2.364,50

Uç Ölçüsü	17mm
Max.Torku	4,50kg/m
Ağırlığı	2,70 Kg
Uzunluğu	417mm
Devir	140d/dk
Hava Girişi	1/4"

FRW-10N-2 17EC

\$2.364,50

Uç Ölçüsü	19mm
Max.Torku	6,00kg/m
Ağırlığı	2,70 Kg
Uzunluğu	419mm
Devir	130d/dk
Hava Girişi	1/4"

FRW-13N-3

\$2.450,80

KALIPÇI TAŞLAMA



Pens Ölçüsü	3mm(1/8")
Ağırlığı	0,40 Kg
Uzunluğu	158mm
Devir	30000d/dk
Egzost	Önden
Hava Girişi	1/4"

FG-13-10F

\$613,30

KALIPÇI TAŞLAMA



Pens Ölçüsü	6mm(1/4")
Ağırlığı	0,50 Kg
Uzunluğu	152mm
Devir	24000d/dk
Egzost	Önden
Hava Girişi	1/4"

FG-26H-1F

\$587,50

KALIPÇI TAŞLAMA



Pens Ölçüsü	3-6mm(1/8-1/4)
Ağırlığı	0,60 Kg
Uzunluğu	188mm
Devir	43000d/dk
Egzost	Yandan
Hava Girişi	1/4"

FG-12U-1

\$732,80

KALIPÇI TAŞLAMA

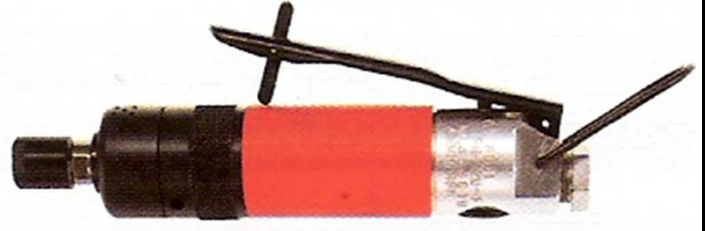

Pens Ölçüsü	3-6mm(1/8-1/4)
Ağırlığı	0,60 Kg
Uzunluğu	188mm
Devir	43000d/dk
Egzost	Yandan
Hava Girişi	1/4"

FG-12U-1F

\$773,80

KALIPÇI TAŞLAMA



Pens Ölçüsü	6mm(1/4")
Ağırlığı	0,50 Kg
Uzunluğu	188mm
Devir	24000d/dk
Egzost	Arkadan
Hava Girişi	1/4"

FG-26HX-1F

\$704,00

KALIPÇI TAŞLAMA



Pens Ölçüsü	6mm(1/4")
Ağırlığı	0,70 Kg
Uzunluğu	180mm
Devir	24000d/dk
Egzost	Yandan
Hava Girişi	1/4"

FG-26-20BF

\$695,00

Pens Ölçüsü	6mm(1/4")
Ağırlığı	0,80 Kg
Uzunluğu	189mm
Devir	18000d/dk
Egzost	Yandan
Hava Girişi	1/4"

FG-50-2BF

\$972,50

KALIPÇI TAŞLAMA



Pens Ölçüsü	3mm(1/8")
Ağırlığı	0,20 Kg
Uzunluğu	153mm
Devir	100000d/dk
Egzost	Önden
Hava Girişi	1/8"

TURBO-100

\$1.183,80

Pens Ölçüsü	6mm(1/4")
Ağırlığı	0,20 Kg
Uzunluğu	155mm
Devir	100000d/dk
Egzost	Önden
Hava Girişi	1/8"

TURBO-100A

\$1.183,80

KALIPÇI TAŞLAMA



Pens Ölçüsü	3-6mm(1/8-1/4)
Ağırlığı	0,80 Kg
Uzunluğu	198mm
Devir	24000d/dk
Egzost	Yandan
Hava Girişi	1/4"

FG-25D-1F

\$802,30

Pens Ölçüsü	3-6mm(1/8-1/4)
Ağırlığı	0,90 Kg
Uzunluğu	210mm
Devir	18000d/dk
Egzost	Yandan
Hava Girişi	1/4"

FG-50D-1F

\$859,80

UZUN TİP KALIPÇI TAŞLAMA



Pens Ölçüsü	6mm(1/4")
Ağırlığı	0,90 Kg
Uzunluğu	306mm
Devir	24000d/dk
Egzost	Yandan
Hava Girişi	1/4"

FG-26L-1BF

\$704,00

UZUN TİP KALIPÇI TAŞLAMA



Pens Ölçüsü	6mm(1/4")
Ağırlığı	0,70 Kg
Uzunluğu	273mm
Devir	24000d/dk
Egzost	Yandan
Hava Girişi	1/4"

FG-26HL-1F

\$645,00

90° KALIPÇI TAŞLAMA



Pens Ölçüsü	6mm(1/4")
Ağırlığı	0,70 Kg
Uzunluğu	188mm
Devir	15000d/dk
Egzost	Yandan
Hava Girişi	1/4"

FA-2C-2BF

\$802,30

KALEM TİP KALIPÇI TAŞLAMA



Pens Ölçüsü	3mm(1/8")
Ağırlığı	0,20 Kg
Uzunluğu	153mm
Devir	60000d/dk
Egzost	Arkadan
Hava Girişi	1/4"

FG-06-1

\$817,00

50mm SATIH TAŞLAMA



Taş çapı	50mm
Diş Ölçüsü	1/4"x28UNF
Ağırlığı	0,70 Kg
Uzunluğu	188mm
Devir	15000d/dk
Hava Girişi	1/4"

FA-20-1F

\$802,30

50mm SATIH TAŞLAMA



Taş çapı	50mm
Diş Ölçüsü	1/4"x28UNF
Ağırlığı	1,00 Kg
Uzunluğu	226mm
Devir	15000d/dk
Hava Girişi	1/4"

FA-2CX-1BF

\$802,50

75mm SATIH TAŞLAMA



Taş çapı	75mm
Diş Ölçüsü	m8x1,25
Ağırlığı	1,30 Kg
Uzunluğu	247mm
Devir	15000d/dk
Hava Girişi	1/4"

FA-3CX-1F

\$1.175,00

100mm SATIH TAŞLAMA



Taş çapı	100mm
Diş Ölçüsü	m8x1,25
Ağırlığı	1,90 Kg
Uzunluğu	208mm
Devir	13500d/dk
Hava Girişi	3/8"

FA-40-1F

\$958,50

125mm SATIH TAŞLAMA



Taş çapı	125mm
Diş Ölçüsü	m8x1,25
Ağırlığı	2,00 Kg
Uzunluğu	262mm
Devir	12000d/dk
Hava Girişi	3/8"

FA-5E-2VF

\$1.179,80

125-180mm SATIH TAŞLAMA



Taş çapı	125mm
Diş Ölçüsü	3/8"x24UNF
Ağırlığı	2,20 Kg
Uzunluğu	262mm
Devir	12000d/dk
Hava Girişi	3/8"

FA-5E-13VF

\$1.179,80

Taş çapı	180mm
Diş Ölçüsü	1/2"x16BSF
Ağırlığı	3,00 Kg
Uzunluğu	353mm
Devir	8400d/dk
Hava Girişi	3/8"

FA-6C-6M

\$1.308,50

Taş çapı	180mm
Diş Ölçüsü	1/2"x16BSF
Ağırlığı	3,10 Kg
Uzunluğu	272mm
Devir	7600d/dk
Hava Girişi	3/8"

FA-7E-6VF

\$1.308,50

Taş çapı	180mm
Diş Ölçüsü	1/2"x16BSF
Ağırlığı	3,10 Kg
Uzunluğu	272mm
Devir	8400d/dk
Hava Girişi	3/8"

FA-7E-8VF

\$1.308,50

125-180mm SATIH TAŞLAMA



Taş çapı	180mm
Diş Ölçüsü	1/2"x16BSF
Ağırlığı	3,00 Kg
Uzunluğu	353mm
Devir	7600d/dk
Hava Girişi	3/8"

FA-6C-8M

\$1.308,50

Taş çapı	230mm
Diş Ölçüsü	5/8"x11UNC
Ağırlığı	4,80 Kg
Uzunluğu	385mm
Devir	5900d/dk
Hava Girişi	1/2"

FA-9C-4M

\$1.744,30

100mm YATAY TİP SATIH TAŞLAMA



Taş çapı	100mm
Diş Ölçüsü	1/2"x12BSW
Ağırlığı	5,40 Kg
Uzunluğu	1050mm
Devir	9000d/dk
Hava Girişi	3/8"

FG-5HL-2M

\$1.662,30

230mm DİK TİP SATIŞ TAŞLAMA



Taş çapı	230mm
Ağırlığı	5,80 Kg
Uzunluğu	278mm
Devir	5900d/dk
Hava Girişi	1/2"

FV-9BH-1M

\$1.934,50

10mm DÜZ TİP MATKAP

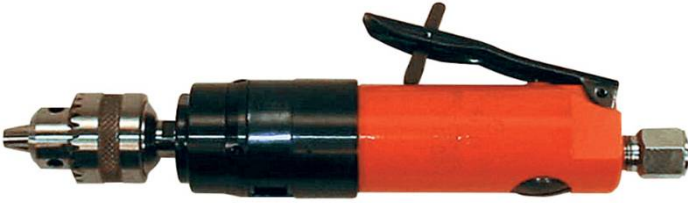

Mandren	10mm
Dönüş	Sağ
Ağırlığı	1,00 Kg
Uzunluğu	233mm
Devir	1300d/dk
Hava Girişi	1/4"

FRD-6S-5F

\$956,00

10mm KABZALI MATKAP



Mandren	10mm
Dönüş	Sağ
Ağırlığı	1,30 Kg
Uzunluğu	187mm
Devir	1300d/dk
Hava Girişi	1/4"

FRD-6PH-5

\$974,80

13mm KABZALI MATKAP



Mandren	13mm
Dönüş	Sağ
Ağırlığı	2,50 Kg
Uzunluğu	240mm
Devir	900d/dk
Hava Girişi	1/4"

FRD-8PX-3

\$1.462,00

16mm KABZALI MATKAP



Mandren	16mm
Dönüş	Sağ
Ağırlığı	3,70 Kg
Uzunluğu	364mm
Devir	800d/dk
Hava Girişi	3/8"

FRD-16Z-1C

\$1.546,50

22-32mm KÖŞE MATKABI



Mandren	22mm
Dönüş	Sağ
Ağırlığı	7,30 Kg
Uzunluğu	282mm
Devir	480d/dk
Hava Girişi	1/2"

FRD-23R-21S

\$2.840,00

Mandren	32mm
Dönüş	Sağ
Ağırlığı	14,50 Kg
Uzunluğu	353mm
Devir	380d/dk
Hava Girişi	1/2"

FRD-32R-11S

\$4.217,80

50mm KÖŞE MATKABI



Mandren	50mm
Dönüş	Sağ
Ağırlığı	18,70 Kg
Uzunluğu	446mm
Devir	150d/dk
Hava Girişi	1/2"

FRD-50R-11S

\$5.905,00

22-32-50mm KÖŞE MATKABI



Mandren	22mm
Raybalama Ölçüsü	19mm
Tork Değeri	8,20kg/m
Dönüş	Sağ-Sol
Ağırlığı	7,00 Kg
Uzunluğu	472mm
Devir	430d/dk
Hava Girişi	1/2"

FCD-23R-11S

\$3.374,30

Mandren	32mm
Raybalama Ölçüsü	32mm
Tork Değeri	18,00kg/m
Dönüş	Sağ-Sol
Ağırlığı	13,50 Kg
Uzunluğu	578mm
Devir	350d/dk
Hava Girişi	1/2"

FCD-32R-11S

\$4.217,80

Mandren	50mm
Raybalama Ölçüsü	50mm
Tork Değeri	40,00kg/m
Dönüş	Sağ-Sol
Ağırlığı	16,00 Kg
Uzunluğu	595mm
Devir	140d/dk
Hava Girişi	1/2"

FRD-50R-11S

\$5.160,00

22-32mm KÖŞE MATKABI



Mandren	22mm
Raybalama Ölçüsü	19mm
Tork Değeri	9,50kg/m
Dönüş	Sağ-Sol
Ağırlığı	8,50 Kg
Uzunluğu	505mm
Devir	400d/dk
Hava Girişi	1/2"

F-22RCR-1S

\$3.149,30

Mandren	32mm
Raybalama Ölçüsü	25mm
Tork Değeri	11,50kg/m
Dönüş	Sağ-Sol
Ağırlığı	10,00 Kg
Uzunluğu	538mm
Devir	315d/dk
Hava Girişi	1/2"

F-32RCR-1S

\$3.374,30

100mm KÖŞE MATKABI



Mandren	100mm
Raybalama Ölçüsü	100mm
Tork Değeri	140,00kg/m
Dönüş	Sağ-Sol
Ağırlığı	29,30 Kg
Uzunluğu	730mm
Devir	40d/dk
Hava Girişi	1/2"

FCD-100R-11S

\$8.660,80

KÖMÜR KIRICI



Piston Çapı	35mm
Piston Stroku	120mm
Ağırlığı	7,80 Kg
Uzunluğu	460mm
Hava Girişi	1/2"

CA-7

\$1.155,00

ÇEKİÇ-KESKİ



Piston Çapı	20mm
Piston Stroku	44,5mm
Ağırlığı	1,50 Kg
Uzunluğu	193mm
Hava Girişi	1/4"

FRH-6A-2

\$681,30

SIKIŞTIRMALI (PULSE) MODEL DÜZ TİP TORNAVİDALAR



Bits Soketi	1/4"
Tork Aralığı	1,50-2,60kg/m
Ağırlığı	0,88 Kg
Uzunluğu	226mm
Devir	5500d/dk
Çekiç Sistemi	2 Bıçaklı Darbe Mekanizmalı
Hava Girişi	1/4"

FL-4SD1

\$2.037,50

Bits Soketi	1/4"
Tork Aralığı	2,60-3,80kg/m
Ağırlığı	0,95 Kg
Uzunluğu	238mm
Devir	5800d/dk
Çekiç Sistemi	2 Bıçaklı Darbe Mekanizmalı
Hava Girişi	1/4"

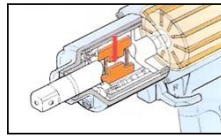

FL-6SD1

\$2.087,50

Bits Soketi	1/4"
Tork Aralığı	2,00-3,50kg/m
Ağırlığı	0,88 Kg
Uzunluğu	226mm
Devir	5700d/dk
Çekiç Sistemi	2 Bıçaklı Darbe Mekanizmalı
Hava Girişi	1/4"

FL-5SD1

\$2.037,50

DÜZ TİP TORNAVİDA



Uç Ölçüsü	1/4"
Kapasitesi	6mm
Çalışma Torku	1,00-1,80kg/m
Ağırlığı	1,10 Kg
Uzunluğu	235mm
Devir	10000d/dk
Hava Girişi	3/8"

FW-6SXD-6

\$1.006,80

YAZI YAZMA



Çapı	20mm
Ağırlığı	0,15 Kg
Uzunluğu	140mm
Hava Girişi	1/4"

G-400

\$887,50

8mm KILAVUZ ÇEKME



Kapasitesi	8mm (5/16") Çelik 10mm(3/8") Alyüminyum
Ağırlığı	2,00 Kg
Uzunluğu	232mm
Devir	450d/dk
Hava Girişi	1/4"

FT-8PX-1

\$1.968,30

13mm KILAVUZ ÇEKME



Kapasitesi	13mm(1/2") Çelik
Ağırlığı	4,00 Kg
Uzunluğu	384mm
Devir	400d/dk
Hava Girişi	3/8"

FT-13Z1

\$2.390,00

PROFESSIONAL PNEUMATIC TOOLS

M
Cat. #
0114
01/2014

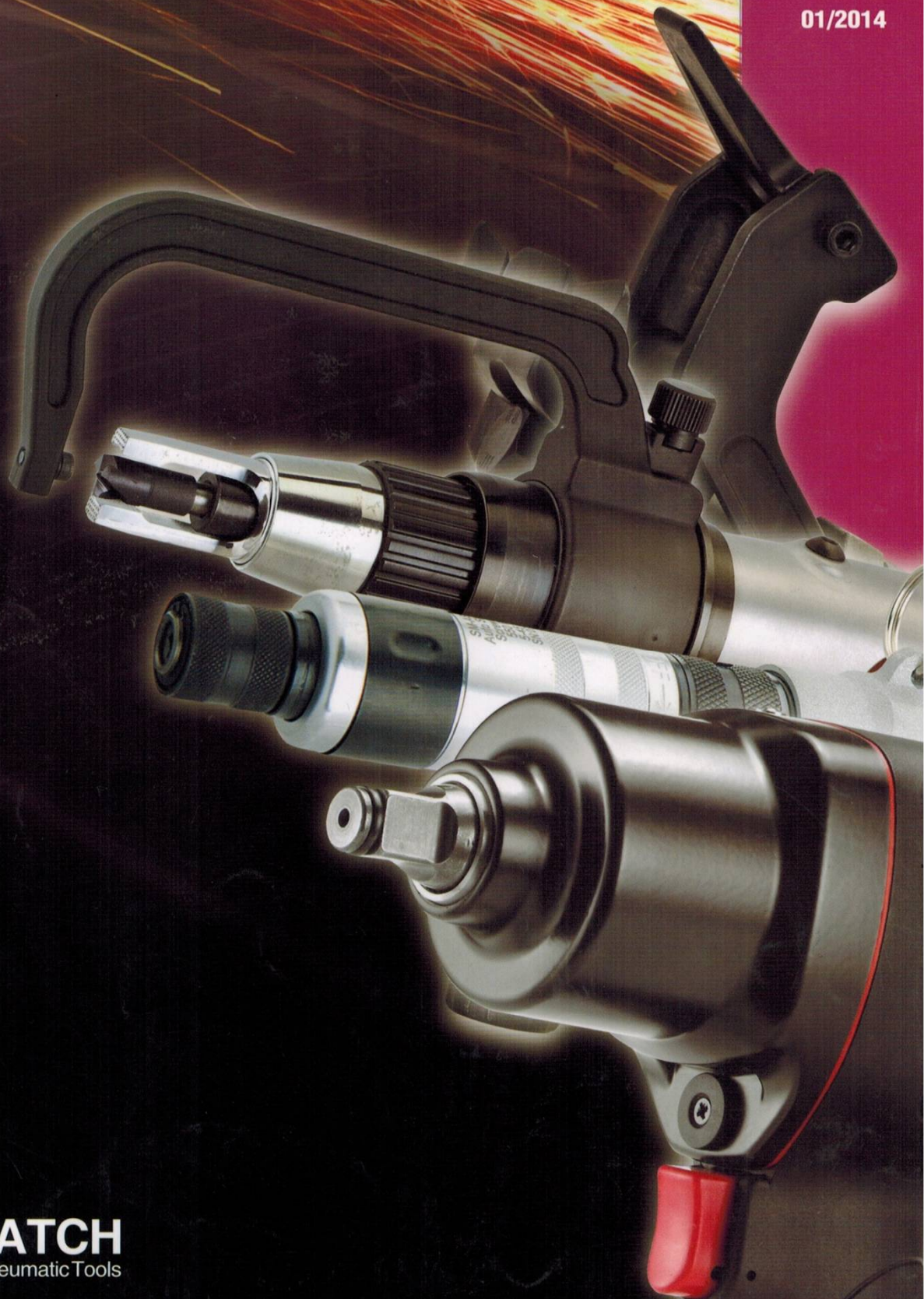

SUNMATCH
Professional Pneumatic Tools

3/8" KELEBEK SOMUN SIKMA-SÖKME



Soket	3/8"
Max.Torku	10,00kg/m
Ağırlığı	0,96 Kg
Uzunluğu	140mm
Devir	10000d/dk
Çekiç Sistemi	Tek çekiç
Hava Girişi	1/4"

SM-401

\$57,20

3/8" KELEBEK SOMUN SIKMA-SÖKME



Soket	3/8"
Max.Torku	12,00kg/m
Ağırlığı	1,00 Kg
Uzunluğu	140mm
Devir	10000d/dk
Çekiç Sistemi	Tek çekiç
Hava Girişi	1/4"

SM-401A

\$90,80

3/8" DÜZ TİP SOMUN SIKMA-SÖKME



Soket	3/8"
Max.Torku	9,50kg/m
Ağırlığı	1,10 Kg
Uzunluğu	210mm
Devir	7000d/dk
Çekiç Sistemi	Çift çekiç
Hava Girişi	1/4"

SG-0775S

\$217,80

3/8" KABZALI SOMUN SIKMA-SÖKME



Soket	3/8"
Max.Torku	10,00kg/m
Ağırlığı	1,00 Kg
Uzunluğu	190mm
Devir	7000d/dk
Çekiç Sistemi	Çift çekiç
Hava Girişi	1/4"

SG-0777

\$217,80

3/8" KABZALI SOMUN SIKMA-SÖKME



Soket	3/8"
Max.Torku	10,00kg/m
Ağırlığı	1,20 Kg
Uzunluğu	127mm
Devir	10000d/dk
Çekiç Sistemi	Tek çekiç
Hava Girişi	1/4"

SG-0775

\$81,40

3/8" KABZALI SOMUN SIKMA-SÖKME



Soket	3/8"
Max.Torku	34,00kg/m
Ağırlığı	1,20 Kg
Uzunluğu	153mm
Devir	10000d/dk
Çekiç Sistemi	İkiz gözlük çekiç
Hava Girişi	1/4"

Composit
Gövde
Düşük ses

SM-41-4012P

\$151,30

1/2" KABZALI SOMUN SIKMA-SÖKME



Soket	1/2"
Max.Torku	34,00kg/m
Ağırlığı	2,40 Kg
Uzunluğu	160mm
Devir	7000d/dk
Çekiç Sistemi	Tek çekiç
Hava Girişi	1/4"

SM-403

\$60,50

Set	m9-10-11-13-14 17-19-22-24-27 Lokmalar Uzatma
-----	--

SM-403K

\$84,70

1/2" KABZALI SOMUN SIKMA-SÖKME



Soket	1/2"
Max.Torku	52,00kg/m
Ağırlığı	2,70 Kg
Uzunluğu	190mm
Devir	7000d/dk
Çekiç Sistemi	Darbe pimli
Hava Girişi	1/4"

SG-0717

\$121,00

1/2" KABZALI SOMUN SIKMA-SÖKME



Composite

Soket	1/2"
Max.Torku	105,00kg/m
Ağırlığı	1,94 Kg
Uzunluğu	185mm
Devir	7500d/dk
Çekiç Sistemi	İkiz gözlük çekiç
Hava Girişi	1/4"

Composit
Gövde
Düşük ses

SM-43-4038P

\$181,50

1/2" KABZALI SOMUN SIKMA-SÖKME



Soket	1/2"
Max.Torku	90,00kg/m
Ağırlığı	2,70 Kg
Uzunluğu	185mm
Devir	9000d/dk
Çekiç Sistemi	İkiz gözlük çekiç
Hava Girişi	1/4"

SM-43-4037G

\$174,90

1/2" KABZALI SOMUN SIKMA-SÖKME



Composite

Soket	1/2"
Max.Torku	78,00kg/m
Ağırlığı	2,08 Kg
Uzunluğu	186mm
Devir	9000d/dk
Çekiç Sistemi	İkiz gözlük çekiç
Hava Girişi	1/4"

Composit
Gövde
Düşük ses

SM-43-4131P1

\$181,50

1/2" KABZALI MİNİ SOMUN SIKMA-SÖKME



Composite

MINI

Soket	1/2"
Max.Torku	63kg/m
Ağırlığı	1,20 Kg
Uzunluğu	153mm
Devir	11000d/dk
Çekiç Sistemi	İkiz gözlük çekiç
Hava Girişi	1/4"

Composit
Gövde
Düşük ses

SM-43-4012P

\$154,00

1/2" KABZALI MİNİ SOMUN SIKMA-SÖKME

CIRCIR TİPİ



MINI

Composite

Soket	1/2"
Max.Torku	32kg/m
Ağırlığı	1,19 Kg
Uzunluğu	88mm
Devir	8000d/dk
Çekiç Sistemi	Tekli gözlük çekiç
Hava Girişi	1/4"

Composit
Gövde
Düşük ses

SM-43-4010

\$176,00

3/4" KABZALI SOMUN SIKMA-SÖKME



Soket	3/4"
Max.Torku	68kg/m
Ağırlığı	4,80 Kg
Uzunluğu	242mm
Devir	4500d/dk
Çekiç Sistemi	Tek çekiç
Hava Girişi	1/4"

SG-0740

\$148,50

3/4" KABZALI SOMUN SIKMA-SÖKME



Soket	3/4"
Max.Torku	95kg/m
Ağırlığı	4,80 Kg
Uzunluğu	248mm
Devir	4800d/dk
Çekiç Sistemi	Darbe pimli
Hava Girişi	1/4"

SG-0751

\$242,00

3/4" KABZALI SOMUN SIKMA-SÖKME



Soket	3/4"
Max.Torku	102kg/m
Ağırlığı	4,50 Kg
Uzunluğu	229mm
Devir	6500d/dk
Çekiç Sistemi	İkiz gözlük çekiç
Hava Girişi	1/4"

SG-0752

\$302,50

3/4" KABZALI SOMUN SIKMA-SÖKME



Composite

Soket	3/4"
Max.Torku	150kg/m
Ağırlığı	3,79 Kg
Uzunluğu	220mm
Devir	5500d/dk
Çekiç Sistemi	İkiz gözlük çekiç
Hava Girişi	3/8"

Composit
Gövde
Düşük ses

SM-45-4153P

\$453,80

3/4" KABZALI SOMUN SIKMA-SÖKME



Soket	3/4"
Max.Torku	150kg/m
Ağırlığı	4,60 Kg
Uzunluğu	220mm
Devir	5500d/dk
Çekiç Sistemi	İkiz gözlük çekiç
Hava Girişi	3/8"

SM-45-4057G

\$313,50

3/4" KABZALI SOMUN SIKMA-SÖKME



Composite

Soket	3/4"-Kısa
Max.Torku	190kg/m
Ağırlığı	3,30 Kg
Uzunluğu	215mm
Devir	5500d/dk
Çekiç Sistemi	İkiz gözlük çekiç
Hava Girişi	3/8"

Composit
Gövde
Düşük ses

SM-45-4051P

\$453,80

Soket	3/4"-Uzun
Max.Torku	190kg/m
Ağırlığı	3,90 Kg
Uzunluğu	368mm
Devir	5500d/dk
Çekiç Sistemi	İkiz gözlük çekiç
Hava Girişi	3/8"

SM-45-4051PL

\$502,20

1" KABZALI SOMUN SIKMA-SÖKME



Soket	1"-Kısa
Max.Torku	163kg/m
Ağırlığı	11,00 Kg
Uzunluğu	455mm
Devir	3500d/dk
Çekiç Sistemi	Pimli çekiç
Hava Girişi	3/8"

SG-0707S

\$473,00

Soket	1"-Uzun
Max.Torku	163kg/m
Ağırlığı	12,80 Kg
Uzunluğu	582mm
Devir	3500d/dk
Çekiç Sistemi	Pimli çekiç
Hava Girişi	3/8"

SG-0707L

\$514,30

1" KABZALI SOMUN SIKMA-SÖKME



Soket	1"-Kısa
Max.Torku	245kg/m
Ağırlığı	9,00 Kg
Uzunluğu	302mm
Devir	3500d/dk
Çekiç Sistemi	Pimli çekiç
Hava Girişi	1/2"

SG-0706S

\$592,90

Soket	1"-Uzun
Max.Torku	245kg/m
Ağırlığı	10,00 Kg
Uzunluğu	429mm
Devir	3500d/dk
Çekiç Sistemi	Pimli çekiç
Hava Girişi	1/2"

SG-0706L

\$641,30

1" DÜZ TİP SOMUN SIKMA-SÖKME



Soket	1"-Kısa
Max.Torku	163kg/m
Ağırlığı	12,00 Kg
Uzunluğu	302mm
Devir	3500d/dk
Çekiç Sistemi	Tek çekiç
Hava Girişi	3/8"

SG-0705S

\$473,00

Soket	1"-Uzun
Max.Torku	163kg/m
Ağırlığı	12,20 Kg
Uzunluğu	429mm
Devir	3500d/dk
Çekiç Sistemi	Tek çekiç
Hava Girişi	3/8"

SG-0705L

\$514,30

1" DÜZ TİP SOMUN SIKMA-SÖKME



Soket	1"-Kısa
Max.Torku	245kg/m
Ağırlığı	11,00 Kg
Uzunluğu	432mm
Devir	3500d/dk
Çekiç Sistemi	Pimli çekiç
Hava Girişi	1/2"

SG-0704S

\$592,90

Soket	1"-Uzun
Max.Torku	245kg/m
Ağırlığı	12,80 Kg
Uzunluğu	582mm
Devir	3500d/dk
Çekiç Sistemi	Pimli çekiç
Hava Girişi	1/2"

SG-0704L

\$641,30

3/4" KABZALI SOMUN SIKMA-SÖKME



Composite

Soket	1"-Kısa
Max.Torku	190kg/m
Ağırlığı	3,40 Kg
Uzunluğu	223mm
Devir	5500d/dk
Çekiç Sistemi	İkiz gözlük çekiç
Hava Girişi	3/8"

Composit
Gövde
Düşük ses

SM-
47-4051P

\$514,30

Soket	1"-Uzun
Max.Torku	190kg/m
Ağırlığı	4,30 Kg
Uzunluğu	370mm
Devir	5500d/dk
Çekiç Sistemi	İkiz gözlük çekiç
Hava Girişi	3/8"

SM-
47-4051P

\$544,50

1/2" KABZALI TORK KONTROLLÜ SOMUN SIKMA-SÖKME

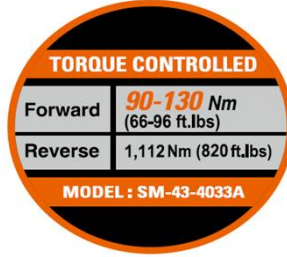

Soket	1/2"
Sıkma Torku	9-13kg/m
Sökme Torku	81kg/m
Ağırlığı	1,90 Kg
Uzunluğu	183mm
Devir	8000d/dk
Çekiç Sistemi	İkiz gözlük çekiç
Hava Girişi	1/4"

SM-43-4033A

\$181,50

1/4"-3/8"-1/2" CIRCIR



Soket	1/4"
Max.Torku	4,15kg/m
Ağırlığı	0,50 Kg
Uzunluğu	168mm
Devir	300d/dk
Hava Girişi	1/4"

SM-32-3100

\$59,40



Soket	3/8"
Max.Torku	7,00kg/m
Ağırlığı	1,20 Kg
Uzunluğu	255mm
Devir	150d/dk
Hava Girişi	1/4"

SM-30

\$48,40

Soket	1/2"
Max.Torku	7,00kg/m
Ağırlığı	1,20 Kg
Uzunluğu	255mm
Devir	150d/dk
Hava Girişi	1/4"

SM-31

\$48,40



Soket	1/2"
Max.Torku	12kg/m
Ağırlığı	2,00 Kg
Uzunluğu	365mm
Devir	150d/dk
Hava Girişi	1/4"

SG-0735

\$157,30

1/2" CIRCIR



Composite

Soket	1/2"
Max. Torku	10,20kg/m
Ağırlığı	1,28 Kg
Uzunluğu	280mm
Devir	400d/dk
Hava Girişi	1/4"

Composit
Gövde
Düşük ses
Otomotiv
Grubu

SM-34-3117

\$181,50

KABZALI TORNAVİDA



Uç Ölçüsü	1/4"
Kapasitesi	6mm
Çalışma Torku	5-13nm
Ağırlığı	1,35 Kg
Uzunluğu	228mm
Devir	1800d/dk
Hava Girişi	1/4"

Diştan
Tork
Ayarlı

SM-882

\$250,80

Uç Ölçüsü	1/4"
Kapasitesi	6mm
Çalışma Torku	5-16,4nm
Ağırlığı	1,50 Kg
Uzunluğu	254mm
Devir	800d/dk
Hava Girişi	1/4"

SM-883

\$276,10

KABZALI TORNAVİDA



Auto Shut-Off

Uç Ölçüsü	1/4"
Kapasitesi	6mm
Çalışma Torku	0,2-5,1nm
Ağırlığı	0,90 Kg
Uzunluğu	210mm
Devir	600d/dk
Hava Girişi	1/4"

Diştan
Tork
Ayarlı
Düşük ses
2 Adet
Tork Yayı
Shut-Off

SM-AS002

\$363,00

KABZALI TORNAVİDA



Auto Shut-Off

Uç Ölçüsü	1/4"
Kapasitesi	6mm
Çalışma Torku	0,4-4,5nm
Ağırlığı	0,90 Kg
Uzunluğu	210mm
Devir	1000d/dk
Hava Girişi	1/4"

Diştan
Tork
Ayarlı
Düşük ses
2 Adet
Tork Yayı
Shut-Off

SM-AS102A

\$363,00

KABZALI TORNAVİDA



Composite

Uç Ölçüsü	1/4"
Kapasitesi	6mm
Çalışma Torku	5-13nm
Ağırlığı	1,30 Kg
Uzunluğu	196mm
Devir	1800d/dk
Hava Girişi	1/4"

Kompozit
Gövde
Dıştan
Tork
Ayarlı
Düşük ses

SM-82-7251F

\$189,20

KABZALI TORNAVİDA



Auto Shut-Off

Uç Ölçüsü	1/4"
Kapasitesi	6mm
Çalışma Torku	0,4-4,5nm
Ağırlığı	0,90 Kg
Uzunluğu	216mm
Devir	1000d/dk
Hava Girişi	1/4"

Dıştan
Tork
Ayarlı
Düşük ses
Shut-Off

SM-AS104

\$363,00

KABZALI TORNAVİDA



Uç Ölçüsü	1/4"
Kapasitesi	10mm
Çalışma Torku	1,22-16,4nm
Ağırlığı	1,00 Kg
Uzunluğu	190mm
Devir	7000d/dk
Hava Girişi	1/4"

Darbeli

SG-0907

\$210,70

KABZALI TORNAVİDA



Ağırlığı	1,00 Kg
Uzunluğu	180mm
Devir	1800d/dk
Hava Girişi	1/4"

SM-88-8020

\$81,00

KABZALI TORNAVİDA



Composite

Uç Ölçüsü	1/4"
Kapasitesi	6mm
Çalışma Torku	5-13nm
Ağırlığı	1,30 Kg
Uzunluğu	196mm
Devir	1800d/dk
Hava Girişi	1/4"

Kompozit
Gövde
Düşük ses

**SM-
82-7254P**

\$189,20

Uç Ölçüsü	1/4"
Kapasitesi	6mm
Çalışma Torku	5-16,4nm
Ağırlığı	1,40 Kg
Uzunluğu	214mm
Devir	800d/dk
Hava Girişi	1/4"

**SM-
83-7254P**

\$223,90

KABZALI TORNAVİDA



Composite

Uç Ölçüsü	1/4"
Kapasitesi	6mm
Çalışma Torku	1,2-11nm
Ağırlığı	1,30 Kg
Uzunluğu	196mm
Devir	1800d/dk
Hava Girişi	1/4"

Kompozit
Gövde
Dıştan
Tork
Ayarlı
Düşük ses

**SM-
82-7254PF**

\$189,20

Uç Ölçüsü	1/4"
Kapasitesi	6mm
Çalışma Torku	1,2-12,4nm
Ağırlığı	1,40 Kg
Uzunluğu	214mm
Devir	800d/dk
Hava Girişi	1/4"

**SM-
83-7254PF**

\$223,90

KABZALI TORNAVİDA



Uç Ölçüsü	1/4"
Kapasitesi	6mm
Çalışma Torku	5-13nm
Ağırlığı	1,15 Kg
Uzunluğu	178mm
Devir	1800d/dk
Hava Girişi	1/4"

SM-802

\$92,40

Uç Ölçüsü	1/4"
Kapasitesi	6mm
Çalışma Torku	5-16,4nm
Ağırlığı	1,20 Kg
Uzunluğu	216mm
Devir	800d/dk
Hava Girişi	1/4"

SM-803

\$116,60

DÜZ TİP TORNAVİDA

Auto Shut-Off



Uç Ölçüsü	1/4"
Kapasitesi	6mm
Çalışma Torku	0,5-5,1nm
Ağırlığı	0,70 Kg
Uzunluğu	240mm
Devir	650d/dk
Hava Girişi	1/4"

Dıştan
Tork
Ayarlı
Düşük ses
2 Adet
Tork Yayı

SM-AS005

\$363,00

Uç Ölçüsü	1/4"
Kapasitesi	6mm
Çalışma Torku	0,3-4,5nm
Ağırlığı	0,70 Kg
Uzunluğu	240mm
Devir	1100d/dk
Hava Girişi	1/4"

SM-AS105

\$363,00

Uç Ölçüsü	1/4"
Kapasitesi	6mm
Çalışma Torku	0,3-2,9nm
Ağırlığı	0,70 Kg
Uzunluğu	240mm
Devir	1800d/dk
Hava Girişi	1/4"

SM-AS205

\$363,00

DÜZ TİP TORNAVİDA

Composite



Uç Ölçüsü	1/4"
Kapasitesi	6mm
Çalışma Torku	1,2-11nm
Ağırlığı	1,20 Kg
Uzunluğu	265mm
Devir	1800d/dk
Hava Girişi	1/4"

Dıştan
Tork
Ayarlı
Düşük ses
Kompozit
Gövde

SM-82-8423F

\$271,20

Uç Ölçüsü	1/4"
Kapasitesi	6mm
Çalışma Torku	1,2-12,4nm
Ağırlığı	1,40 Kg
Uzunluğu	283mm
Devir	800d/dk
Hava Girişi	1/4"

Dıştan
Tork
Ayarlı
Düşük ses
Kompozit
Gövde

SM-83-8423F

\$286,00

DÜZ TİP TORNAVİDA



Uç Ölçüsü	1/4"
Kapasitesi	6mm
Çalışma Torku	5-13nm
Ağırlığı	1,35 Kg
Uzunluğu	266mm
Devir	1800d/dk
Hava Girişi	1/4"

Dıştan
Tork
Ayarlı

SM-872

\$283,30

Uç Ölçüsü	1/4"
Kapasitesi	6mm
Çalışma Torku	5-16,4nm
Ağırlığı	1,50 Kg
Uzunluğu	293mm
Devir	800d/dk
Hava Girişi	1/4"

Dıştan
Tork
Ayarlı

SM-873

\$312,40

DÜZ TİP TORNAVİDA



Uç Ölçüsü	1/4"
Kapasitesi	6mm
Çalışma Torku	5-13nm
Ağırlığı	1,05 Kg
Uzunluğu	255mm
Devir	1800d/dk
Hava Girişi	1/4"

SM-842

\$133,10

Uç Ölçüsü	1/4"
Kapasitesi	6mm
Çalışma Torku	5-16,4nm
Ağırlığı	1,20 Kg
Uzunluğu	280mm
Devir	800d/dk
Hava Girişi	1/4"

SM-843

\$145,20

DÜZ TİP TORNAVİDA

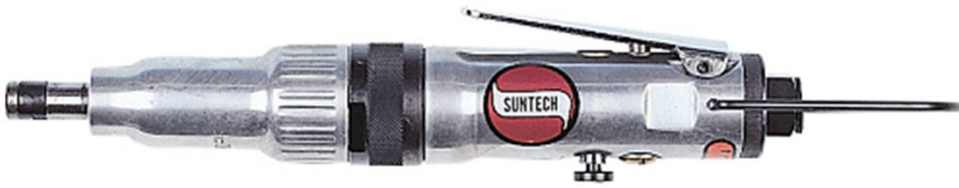

Uç Ölçüsü	1/4"
Kapasitesi	6mm
Çalışma Torku	1,2-3,4nm
Ağırlığı	0,60 Kg
Uzunluğu	210mm
Devir	1500d/dk
Hava Girişi	1/4"

SG-0909

\$90,80

DÜZ TİP TORNAVİDA



Uç Ölçüsü	1/4"
Kapasitesi	10mm
Çalışma Torku	1,2-15nm
Ağırlığı	1,00 Kg
Uzunluğu	210mm
Devir	7000d/dk
Hava Girişi	1/4"

Darbeli

SG-0907S

\$210,70

DÜZ TİP TORNAVİDA



Uç Ölçüsü	1/4"
Kapasitesi	6mm
Çalışma Torku	2,2-7nm
Ağırlığı	0,70 Kg
Uzunluğu	190mm
Devir	8000d/dk
Hava Girişi	1/4"

Darbeli

SG-0905

\$101,80

DÜZ TİP TORNAVİDA



Uç Ölçüsü	1/4"
Kapasitesi	6mm
Çalışma Torku	2,2-7nm
Ağırlığı	0,67 Kg
Uzunluğu	195mm
Devir	9000d/dk
Hava Girişi	1/4"

Darbeli

SG-0320

\$187,00

Auto Shut-Off

6mm KABZALI MATKAP



Composite

Mandren	6mm
Dönüş	Sağ-Sol
Ağırlığı	0,60 Kg
Uzunluğu	148mm
Devir	2600d/dk
Hava Girişi	1/4"

Kompozit
Gövde
Düşük ses

**SM-78-
7284PR-02**

\$137,50

10mm KABZALI MATKAP



Mandren	10mm
Dönüş	Sağ
Ağırlığı	1,15 Kg
Uzunluğu	165mm
Devir	2600d/dk
Hava Girişi	1/4"

SM-706

\$59,40

10mm KABZALI MATKAP



Mandren	10mm
Dönüş	Sağ
Ağırlığı	1,15 Kg
Uzunluğu	165mm
Devir	2200d/dk
Hava Girişi	1/4"

SM-701

\$72,60

10mm KABZALI MATKAP



Composite

Mandren	10mm
Dönüş	Sağ
Ağırlığı	1,10 Kg
Uzunluğu	185mm
Devir	2600d/dk
Hava Girişi	1/4"

Kompozit
Gövde
Düşük ses

SM-76-7254P

\$128,70

10mm KABZALI MATKAP



Mandren	10mm
Dönüş	Sağ
Ağırlığı	1,00 Kg
Uzunluğu	200mm
Devir	2600d/dk
Hava Girişi	1/4"

1 hp güç
Tetikten
2 hız
Ayarlı

SM-7026A

\$247,50

10mm KABZALI MATKAP



Mandren	10mm
Dönüş	Sağ-Sol
Ağırlığı	1,35 Kg
Uzunluğu	165mm
Devir	1800d/dk
Hava Girişi	1/4"

SM-705

\$60,50

10mm KABZALI MATKAP



Composite

Mandren	10mm
Dönüş	Sağ-Sol
Ağırlığı	1,10 Kg
Uzunluğu	185mm
Devir	1800d/dk
Hava Girişi	1/4"

Kompozit
Gövde
Düşük ses
2 Hızlı
tetik

SM-75-7254P

\$133,10

10mm DÜZ TİP MATKAP



Composite

Mandren	10mm
Dönüş	Sağ
Ağırlığı	1,10 Kg
Uzunluğu	241mm
Devir	2500d/dk
Hava Girişi	1/4"

Kompozit
Gövde
Düşük ses

SM-76-3011B

\$175,50

10mm DÜZ TİP MATKAP



Mandren	10mm
Dönüş	Sağ
Ağırlığı	0,90 Kg
Uzunluğu	190mm
Devir	4500d/dk
Hava Girişi	1/4"

SM-746

\$108,90

10mm DÜZ TİP MATKAP



Mandren	10mm
Dönüş	Sağ
Ağırlığı	0,70 Kg
Uzunluğu	186mm
Devir	22000d/dk
Hava Girişi	1/4"

SM-502

\$47,30

10mm DÜZ TİP MATKAP



Mandren	10mm
Dönüş	Sağ
Ağırlığı	0,90 Kg
Uzunluğu	216mm
Devir	2600d/dk
Hava Girişi	1/4"

SM-710

\$96,80

10mm 90° MATKAP



Mandren	10mm
Dönüş	Sağ
Ağırlığı	1,15 Kg
Uzunluğu	204mm
Devir	1900d/dk
Hava Girişi	1/4"

SM-709

\$119,90

10mm 90° MATKAP



Mandren	10mm
Dönüş	Sağ-Sol
Ağırlığı	1,80 Kg
Uzunluğu	178mm
Devir	1500d/dk
Hava Girişi	1/4"

SM-709R

\$127,10

13mm KABZALI MATKAP



Mandren	13mm
Dönüş	Sağ-Sol
Ağırlığı	1,80 Kg
Uzunluğu	178mm
Devir	800d/dk
Hava Girişi	1/4"

SM-704

\$116,60

13mm KABZALI MATKAP



Mandren	13mm
Dönüş	Sağ
Ağırlığı	1,80 Kg
Uzunluğu	178mm
Devir	500d/dk
Hava Girişi	1/4"

SM-703

\$96,80

13mm KABZALI MATKAP



Composite

Mandren	13mm
Dönüş	Sağ-Sol
Ağırlığı	1,30 Kg
Uzunluğu	218mm
Devir	800d/dk
Hava Girişi	1/4"

Kompozit
Gövde
Düşük ses
2 Hızlı
tetik

SM-74-7254P

\$170,50

13mm KABZALI MATKAP



Composite

Mandren	13mm
Dönüş	Sağ
Ağırlığı	1,30 Kg
Uzunluğu	218mm
Devir	1000d/dk
Hava Girişi	1/4"

Kompozit
Gövde
Düşük ses
2 Hızlı
tetik

SM-72-7254P

\$163,40

13mm KABZALI MATKAP



Mandren	13mm
Dönüş	Sağ-Sol
Ağırlığı	1,70 Kg
Uzunluğu	224mm
Devir	800d/dk
Hava Girişi	1/4"

SM-74-7251

\$170,50

16mm MATKAP



Mandren	16mm
Dönüş	Sağ
Ağırlığı	3,30 Kg
Uzunluğu	328mm
Devir	800d/dk
Hava Girişi	1/4"

Ağır Hizmet

SM-7H-7538

\$943,80

PUNTA ÇÜRÜTME



Punta Mat. Ölçüsü	8mm
Ağırlığı	2,50 Kg
Uzunluğu	250mm
Devir	2000d/dk
Hava Girişi	1/4"

SM-721

\$240,90

PUNTA ÇÜRÜTME



Punta Mat. Ölçüsü	8mm
Ağırlığı	2,30 Kg
Uzunluğu	349mm
Devir	800d/dk
Hava Girişi	1/4"

Kompozit Gövde

SM-71-7802

\$412,50

PUNTA ÇÜRÜTME

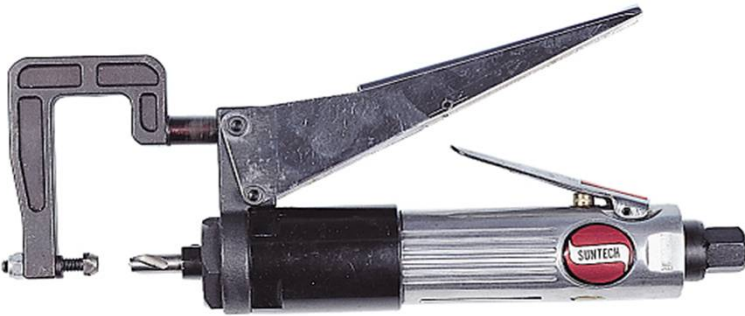

Punta Mat. Ölçüsü	8mm
Ağırlığı	1,50 Kg
Uzunluğu	274mm
Devir	500d/dk
Hava Girişi	1/4"

SM-730

\$130,90

KALIPÇI TAŞLAMA

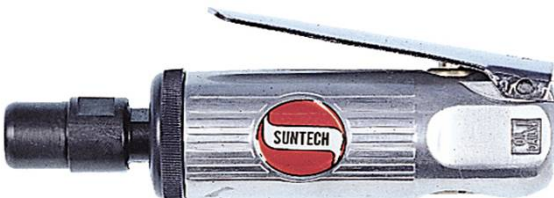

Pens Ölçüsü	6mm
Ağırlığı	0,45 Kg
Uzunluğu	121mm
Devir	25000d/dk
Egzost	Önden
Hava Girişi	1/4"

SM-552

\$36,30

KALIPÇI TAŞLAMA



Pens Ölçüsü	6mm
Ağırlığı	0,40 Kg
Uzunluğu	152mm
Devir	25000d/dk
Egzost	Arkadan
Hava Girişi	1/4"

SM-532

\$36,30



Pens Ölçüsü	6mm
Ağırlığı	0,50 Kg
Uzunluğu	172mm
Devir	22000d/dk
Egzost	Arkadan
Hava Girişi	1/4"

SM-512

\$36,30

SET	10 adet muhtelif Saplı taş 3-6mm Pens Rakor
-----	--

SM-512K

\$48,40

KALIPÇI TAŞLAMA



Pens Ölçüsü	6mm
Ağırlığı	0,60 Kg
Uzunluğu	165mm
Devir	22000d/dk
Egzost	Önden
Hava Girişi	1/4"

SM-501C

\$48,40

KALIPÇI TAŞLAMA



Composite

Pens Ölçüsü	6mm
Ağırlığı	0,50 Kg
Uzunluğu	170mm
Devir	22000d/dk
Egzost	Arkadan
Hava Girişi	1/4"

Kompozit
Gövde
Düşük ses

SM-572P

\$85,80

KALIPÇI TAŞLAMA



Pens Ölçüsü	6mm
Ağırlığı	0,65 Kg
Uzunluğu	204mm
Devir	4500d/dk
Egzost	Arkadan
Hava Girişi	1/4"

SM-545

\$108,90

KALIPÇI TAŞLAMA



Composite

Pens Ölçüsü	6mm
Ağırlığı	0,70 Kg
Uzunluğu	188mm
Devir	20000d/dk
Egzost	Arkadan
Hava Girişi	1/4"

Kompozit
Gövde
Düşük ses

SM-51-3011B

\$85,80

KALIPÇI TAŞLAMA



Composite

Pens Ölçüsü	6mm
Ağırlığı	0,80 Kg
Uzunluğu	200mm
Devir	22000d/dk
Egzost	Arkadan
Hava Girişi	1/4"

Kompozit
Gövde
Düşük ses

SM-50-5200

\$132,00

KALIPÇI TAŞLAMA



Composite

Pens Ölçüsü	6mm
Ağırlığı	0,70 Kg
Uzunluğu	190mm
Devir	20000d/dk
Egzost	Arkadan
Hava Girişi	1/4"

Kompozit
Gövde
Düşük ses

SM-51-5100

\$77,00

KALIPÇI TAŞLAMA



Composite

Pens Ölçüsü	6mm
Ağırlığı	0,60 Kg
Uzunluğu	210mm
Devir	4500d/dk
Egzost	Arkadan
Hava Girişi	1/4"

Kompozit
Gövde
Düşük ses

SM-575P

\$96,80

KALIPÇI TAŞLAMA



Pens Ölçüsü	6mm
Ağırlığı	0,73 Kg
Uzunluğu	180mm
Devir	32000d/dk
Egzost	Yandan,hareketli
Hava Girişi	1/4"

Çelik
Gövde
Endüstriyel
Tip

SM-53-5530

\$90,80

KALIPÇI TAŞLAMA

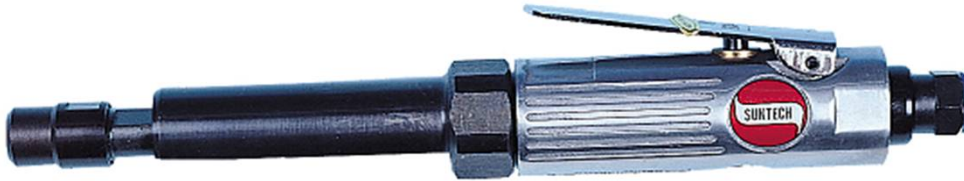

Pens Ölçüsü	6mm
Ağırlığı	0,90 Kg
Uzunluğu	248mm
Devir	25000d/dk
Egzost	Arkadan
Hava Girişi	1/4"

SM-532E

\$80,30

Pens Ölçüsü	6mm
Ağırlığı	1,20 Kg
Uzunluğu	335mm
Devir	22000d/dk
Egzost	Arkadan
Hava Girişi	1/4"

SM-512F

\$83,60

KALIPÇI TAŞLAMA



Composite

Pens Ölçüsü	6mm
Ağırlığı	0,90 Kg
Uzunluğu	251mm
Devir	25000d/dk
Egzost	Arkadan
Hava Girişi	1/4"

Gövde
Düşük ses

SM-5E-5227

\$89,70

Pens Ölçüsü	6mm
Ağırlığı	1,20 Kg
Uzunluğu	330mm
Devir	22000d/dk
Egzost	Arkadan
Hava Girişi	1/4"

SM-572FP

\$90,80

KALIPÇI TAŞLAMA



Pens Ölçüsü	6mm
Ağırlığı	1,30 Kg
Uzunluğu	317,5mm
Devir	12000d/dk
Egzost	Arkadan
Hava Girişi	1/4"

SM-5001

\$220,00

90° KALIPÇI TAŞLAMA



Pens Ölçüsü	6mm
Ağırlığı	0,45 Kg
Uzunluğu	160mm
Devir	22000d/dk
Egzost	Arkadan
Hava Girişi	1/4"

90
Derece

SM-522

\$71,50

90° KALIPÇI TAŞLAMA



Composite

Pens Ölçüsü	6mm
Ağırlığı	0,60 Kg
Uzunluğu	170mm
Devir	20000d/dk
Egzost	Arkadan
Hava Girişi	1/4"

Kompozit
Gövde
Düşük ses

SM-52-5227

\$101,80

115° KALIPÇI TAŞLAMA



Composite

Pens Ölçüsü	6mm
Ağırlığı	0,70 Kg
Uzunluğu	200mm
Devir	20000d/dk
Egzost	Arkadan
Hava Girişi	1/4"

115
Derece
Kompozit
Gövde
Düşük ses

SM-55-5227

\$101,80

KALEM TİP KALIPÇI TAŞLAMA



Pens Ölçüsü	3mm
Ağırlığı	0,15 Kg
Uzunluğu	134mm
Devir	54000d/dk
Egzost	Arkadan
Hava Girişi	1/4"

Kalem
Tip

SM-516

\$115,00

KALEM TİP KALIPÇI TAŞLAMA



Pens Ölçüsü	3mm
Ağırlığı	0,20 Kg
Uzunluğu	133mm
Devir	82000d/dk
Egzost	Arkadan
Hava Girişi	1/4"

Kalem
Tip

SG-0582

\$231,00

KALEM TİP KALIPÇI TAŞLAMA



Pens Ölçüsü	6mm
Ağırlığı	0,57 Kg
Uzunluğu	200mm
Devir	35000d/dk
Egzost	Arkadan
Hava Girişi	1/4"

Kompozit
Gövde
Düşük ses
Kalem
Tip
Endüstriyel
Tip

SM-53-5522

\$453,80

LASTİK TAŞLAMA

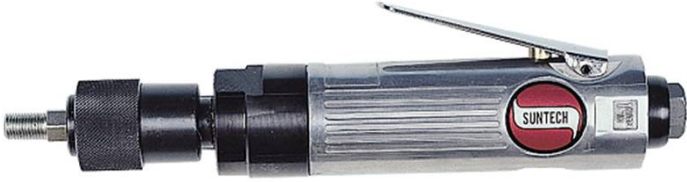

Uç Tipi	Şipşaklı
Ağırlığı	0,60 Kg
Uzunluğu	216mm
Devir	2600d/dk
Egzost	Arkadan
Hava Girişi	1/4"

SM-661

\$96,80

LASTİK TAŞLAMA



Uç Tipi	Taşlı
Ağırlığı	0,60 Kg
Uzunluğu	222mm
Devir	2500d/dk
Egzost	Arkadan
Hava Girişi	1/4"

SM-662

\$96,80

LASTİK TAŞLAMA



Uç Tipi	Şipşaklı
Ağırlığı	1,20 Kg
Uzunluğu	838mm
Devir	4500d/dk
Egzost	Arkadan
Hava Girişi	1/4"

SM-747

\$108,90

LASTİK TAŞLAMA



Uç Tipi	Şipşaklı
Ağırlığı	0,90 Kg
Uzunluğu	215mm
Devir	2600d/dk
Egzost	Arkadan
Hava Girişi	1/4"

Kompozit
Gövde
Düşük ses

SM-671P

\$106,70

50mm SATIH TAŞLAMA



Composite

Taş Çapı	50mm
Diş Ölçüsü	3/8"x24UNF
Ağırlığı	0,60 Kg
Uzunluğu	133mm
Devir	20000d/dk
Hava Girişi	1/4"

Kompozit
Gövde
Düşük ses

SM-6542

\$141,90

50mm SATIH TAŞLAMA



Composite

Taş Çapı	50mm
Diş Ölçüsü	3/8"x24UNF
Ağırlığı	0,60 Kg
Uzunluğu	133mm
Devir	20000d/dk
Hava Girişi	1/4"

Kompozit
Gövde
Düşük ses

SM-5J-5423K

\$174,40

100mm SATIH TAŞLAMA



Taş Çapı	100mm
Diş Ölçüsü	7/16"x20UNF
Ağırlığı	1,35 Kg
Uzunluğu	152mm
Devir	18000d/dk
Hava Girişi	1/4"

SG-0502

\$47,30

100mm SATIH TAŞLAMA



Taş Çapı	100mm
Diş Ölçüsü	3/8"x24UNF
Ağırlığı	1,50 Kg
Uzunluğu	222mm
Devir	11000d/dk
Hava Girişi	1/4"

Düşük ses

SG-0520

\$150,20

125mm SATIH TAŞLAMA



Taş Çapı	125mm
Diş Ölçüsü	m10x1,5 / m14x2
Ağırlığı	1,90 Kg
Uzunluğu	228mm
Devir	11000d/dk
Hava Girişi	1/4"

SG-0519-5

\$150,20

125mm SATIH TAŞLAMA



Composite

Taş Çapı	125mm
Diş Ölçüsü	m14x2
Ağırlığı	2,00 Kg
Uzunluğu	238mm
Devir	10000d/dk
Hava Girişi	1/4"

Kompozit
Gövde
Düşük ses

SM-5D-6192PS/M14

\$199,70

125mm SATIH TAŞLAMA



Composite

Taş Çapı	125mm
Diş Ölçüsü	m14x2
Ağırlığı	1,54 Kg
Uzunluğu	210mm
Devir	12000d/dk
Hava Girişi	1/4"

Kompozit
Gövde
Düşük ses

SM-5D-6401R

\$217,80

180mm SATIH TAŞLAMA



Taş Çapı	180mm
Diş Ölçüsü	5/8x11BSW
Ağırlığı	3,00 Kg
Uzunluğu	323mm
Devir	8400d/dk
Güç	2,2hp
Hava Girişi	3/8"

SM-5G-6413

\$583,00

180mm SATIH TAŞLAMA



Taş Çapı	180mm
Diş Ölçüsü	m14x2
Ağırlığı	3,50 Kg
Uzunluğu	350mm
Devir	7000d/dk
Hava Girişi	3/8"

SM-5G-6197M14

\$242,00

Taş Çapı	180mm
Diş Ölçüsü	5/8x11BSW
Ağırlığı	3,50 Kg
Uzunluğu	350mm
Devir	7000d/dk
Hava Girişi	3/8"

SM-5G-6197/58

\$242,00

180mm SATIH TAŞLAMA



Taş Çapı	180mm
Diş Ölçüsü	5/8x11BSW
Ağırlığı	3,00 Kg
Uzunluğu	277mm
Devir	8400d/dk
Güç	2,2hp
Hava Girişi	3/8"

SM-5G-6413R

\$583,00

180mm SATIH TAŞLAMA



Taş Çapı	180mm
Diş Ölçüsü	5/8x11BSW
Ağırlığı	5,30 Kg
Uzunluğu	295mm
Devir	6000d/dk
Güç	4hp
Hava Girişi	1/2"

SM-5G-421V

\$632,50

230mm SATIİH TAŞLAMA



Taş Çapı	230mm
Diş Ölçüsü	5/8x11BSW
Ağırlığı	5,50 Kg
Uzunluğu	337mm
Devir	6000d/dk
Güç	4 hp
Hava Girişi	1/2"

SM-5H-400V

\$632,50

230mm SATIİH TAŞLAMA



Taş Çapı	230mm
Diş Ölçüsü	5/8x11BSW
Ağırlığı	5,60 Kg
Uzunluğu	332mm
Devir	6000d/dk
Güç	4 hp
Hava Girişi	1/2"

SM-5H-421V

\$632,50

75mm YATAY TİP SATIİH TAŞLAMA



Taş Çapı	75mm
Diş Ölçüsü	3/8"x24UNF
Ağırlığı	0,65 Kg
Uzunluğu	425mm
Devir	7000d/dk
Hava Girişi	1/4"

SG-0523

\$338,00

100mm UZUN TİP SATIİH TAŞLAMA VE KESME



Taş Çapı	100mm
Ağırlığı	1,40 Kg
Uzunluğu	304mm
Devir	17000d/dk
Hava Girişi	1/4"

**Kompozit
Gövde
Düşük ses**

SM-5L-3011B

\$189,20

POLİSAJ



Disk Çapı	180mm
Diş Ölçüsü	5/8x11BSW
Ağırlığı	2,25 Kg
Uzunluğu	406mm
Devir	2500d/dk
Hava Girişi	1/4"

SG-0472

\$139,20

Disk Çapı	180mm
Diş Ölçüsü	m14x2
Ağırlığı	2,00 Kg
Uzunluğu	307mm
Devir	2500d/dk
Hava Girişi	1/4"

**SM-6N-
6661M14**

\$199,70

DAİRESEL ZIMPARA



Disk Çapı	180mm
Diş Ölçüsü	5/8x11BSW
Ağırlığı	2,25 Kg
Uzunluğu	406mm
Devir	4500d/dk
Hava Girişi	1/4"

SG-0470

\$133,10

Disk Çapı	180mm
Diş Ölçüsü	m14x2
Ağırlığı	2,00 Kg
Uzunluğu	307mm
Devir	4500d/dk
Hava Girişi	1/4"

SM-67-6661M14

\$193,60

DAİRESEL ZIMPARA

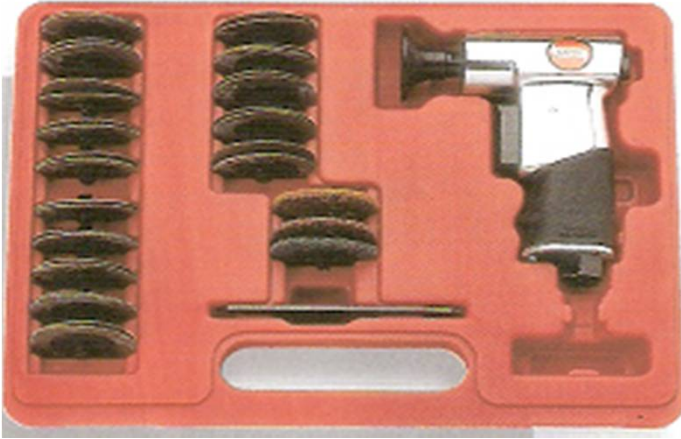

Disk Çapı	50mm
Diş Ölçüsü	1/4"x20BSW
Ağırlığı	0,80 Kg
Uzunluğu	117mm
Devir	15000d/dk
Hava Girişi	1/4"

SM-6001-2K

\$237,60

Disk Çapı	75mm
Diş Ölçüsü	1/4"x20BSW
Ağırlığı	0,80 Kg
Uzunluğu	117mm
Devir	15000d/dk
Hava Girişi	1/4"

SM-6001-3K

\$237,60

POLİSAJ



Disk Çapı	75mm
Ağırlığı	0,90 Kg
Uzunluğu	127mm
Devir	2500d/dk
Hava Girişi	1/4"

SM-6004K

\$178,20

DAİRESEL ZIMPARA



Disk Çapı	30mm
Ağırlığı	0,22 Kg
Uzunluğu	158mm
Devir	22000d/dk
Hava Girişi	1/4"

SM-572

\$283,30

DAİRESEL ZIMPARA



Disk Çapı	75-115-140mm
Ağırlığı	1,00 Kg
Uzunluğu	142mm
Devir	16000d/dk
Hava Girişi	1/4"

Sağ-Sol

SM-60-8020

\$121,00

DAİRESEL ZIMPARA



Disk Çapı	75-125-140mm
Ağırlığı	1,00 Kg
Uzunluğu	134mm
Devir	16000d/dk
Hava Girişi	1/4"

Sağ-Sol

SM-60-8130

\$121,00

SULU TİP DAİRESEL ZIMPARA



Disk Çapı	150mm
Diş Ölçüsü	5/8"x11BSW
Ağırlığı	2,25 Kg
Uzunluğu	198mm
Devir	1000d/dk
Hava Girişi	1/4"

Sulu Tip

SM-615

\$432,30

EKSANTRİK DAİRESEL ZIMPARA

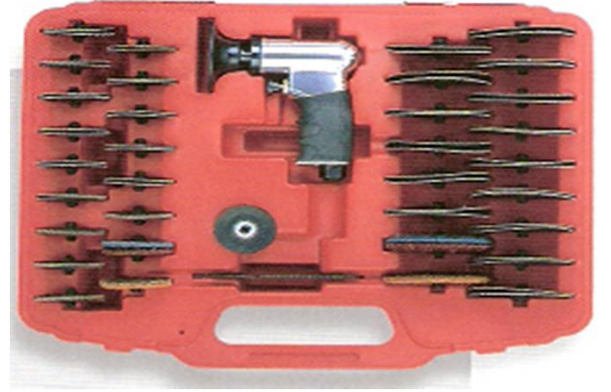

Disk Çapı / Ekst.	75mm/ 3mm
Diş Ölçüsü	1/4"x20BSW
Ağırlığı	0,70 Kg
Uzunluğu	109mm
Devir	15000d/dk
Hava Girişi	1/4"

Tetikten
Hız
Ayarlı

SM-72831K

\$237,60

EKSANTRİK DAİRESEL ZIMPARA

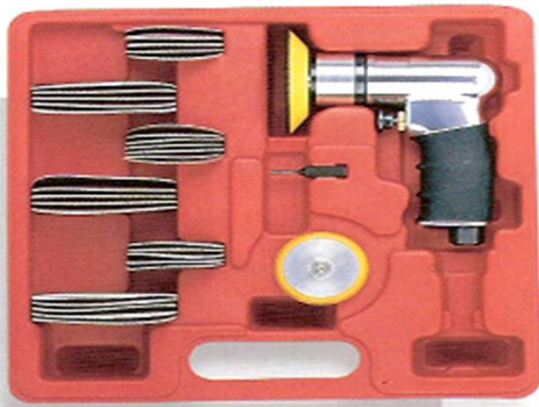

Disk Çapı / Ekst.	75mm/ 3mm
Diş Ölçüsü	m6x1
Ağırlığı	0,70 Kg
Uzunluğu	117mm
Devir	15000d/dk
Hava Girişi	1/4"

SM-72833K

\$178,20

EKSANTRİK DAİRESEL ZIMPARA



Disk Çapı / Ekst.	75mm/ 3mm
Diş Ölçüsü	1/4"x20BSW
Ağırlığı	0,80 Kg
Uzunluğu	113mm
Devir	15000d/dk
Hava Girişi	1/4"

SM-6003VK

\$178,20

EKSANTRİK DAİRESEL ZIMPARA



Disk Çapı / Ekst.	150mm/ 5mm
Diş Ölçüsü	5/16"x24UNF
Ağırlığı	1,70 Kg
Uzunluğu	222mm
Devir	10000d/dk
Hava Girişi	1/4"

SG-0420

\$61,60

Disk Çapı / Ekst.	200mm/ 5mm
Diş Ölçüsü	5/16"x24UNF
Ağırlığı	2,00 Kg
Uzunluğu	292mm
Devir	3500d/dk
Hava Girişi	1/4"

SG-0414

\$127,10

EKSANTRİK DAİRESEL ZIMPARA



Disk Çapı / Ekst.	150mm/ 5mm
Diş Ölçüsü	5/16"x24UNF
Ağırlığı	1,35 Kg
Uzunluğu	152mm
Devir	10000d/dk
Hava Girişi	1/4"

SM-603

\$169,40



Disk Çapı / Ekst.	150mm/ 5mm
Diş Ölçüsü	5/16"x24UNF
Ağırlığı	1,80 Kg
Uzunluğu	152mm
Devir	10000d/dk
Hava Girişi	1/4"

Toz Emişli

SM-603V

\$217,80

EKSANTRİK DAİRESEL ZIMPARA



Disk Çapı / Ekst.	150mm/ 5mm
Diş Ölçüsü	5/16"x24UNF
Ağırlığı	0,76 Kg
Uzunluğu	163-213mm
Devir	11000d/dk
Hava Girişi	1/4"

**Kompozit
Gövde
Düşük ses**

**SM-
66-6133**

\$181,50



Disk Çapı / Ekst.	150mm/ 5mm
Diş Ölçüsü	5/16"x24UNF
Ağırlığı	0,78 Kg
Uzunluğu	163-213mm
Devir	11000d/dk
Hava Girişi	1/4"

Toz Emişli

**SM-
66-6133A**

\$290,40

EKSANTRİK DAİRESEL ZIMPARA



Disk Çapı / Ekst.	150mm / 5mm
Diş Ölçüsü	5/16"x24UNF
Ağırlığı	1,00 Kg
Uzunluğu	268mm
Devir	10000d/dk
Hava Girişi	1/4"

Kompozit
Gövde
Düşük ses

SM-66-6132

\$181,50

Composite

Disk Çapı / Ekst.	150mm / 5mm
Diş Ölçüsü	5/16"x24UNF
Ağırlığı	1,00 Kg
Uzunluğu	268mm
Devir	10000d/dk
Hava Girişi	1/4"

Kompozit
Gövde
Düşük ses

Toz Emişli

SM-66-6132A

\$290,40

EKSANTRİK DAİRESEL ZIMPARA



Disk Çapı / Ekst.	150mm / 5mm
Diş Ölçüsü	5/16"x24UNF
Ağırlığı	2,70 Kg
Uzunluğu	266mm
Devir	7000d/dk
Hava Girişi	1/4"

SG-9604V

\$214,50

EKSANTRİK DAİRESEL ZIMPARA



Composite

Disk Çapı / Ekst.	150mm / 5mm
Diş Ölçüsü	5/16"x24UNF
Ağırlığı	0,78 Kg
Uzunluğu	213mm
Devir	11000d/dk
Hava Girişi	1/4"

Kompozit
Gövde
Düşük ses

Toz Emişli

SM-66-6133C

\$266,20

EKSANTRİK DAİRESEL ZIMPARA

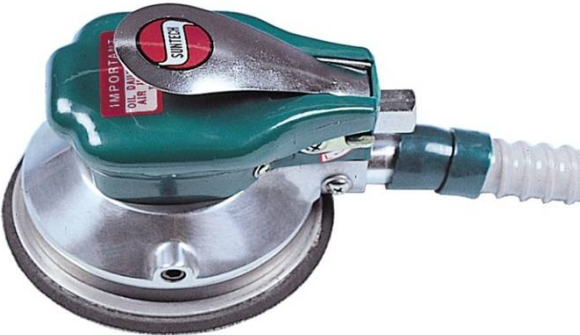

Disk Çapı / Ekst.	125mm / 5mm
Ağırlığı	1,00 Kg
Uzunluğu	168mm
Devir	9000d/dk
Hava Girişi	1/4"

SM-640

\$174,40

EKSANTRİK TİTEŞİMLİ ZIMPARA

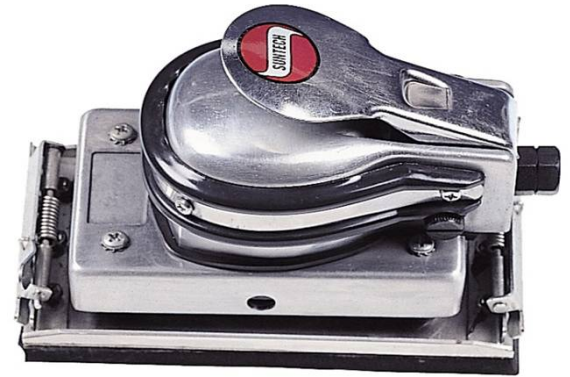

Taban Ölçüsü	95x165mm
Eksantrik	5mm
Ağırlığı	1,80 Kg
Uzunluğu	188mm
Devir	8000d/dk
Hava Girişi	1/4"

SG-0416

\$54,50

EKSANTRİK TİTEŞİMLİ ZIMPARA



Taban Ölçüsü	75x150mm
Eksantrik	5mm
Ağırlığı	1,20 Kg
Uzunluğu	160mm
Devir	8000d/dk
Hava Girişi	1/4"

Toz Emişi

SM-650

\$189,20

EKSANTRİK TİTEŞİMLİ ZIMPARA



Taban Ölçüsü	112x220mm
Eksantrik	5mm
Ağırlığı	2,30 Kg
Uzunluğu	284mm
Devir	6500d/dk
Hava Girişi	1/4"

Toz Emişi

SM-6205D

\$357,00

RENDE ZIMPARA



Taban Ölçüsü	70x440mm
Strok	25mm
Ağırlığı	2,80 Kg
Uzunluğu	406mm
Devir	3000d/dk
Hava Girişi	1/4"

SG-0430

\$138,10

EKSANTRİK TİTREŞİMLİ KÖŞE ZIMPARA



Disk Çapı	75mm
Ağırlığı	1,20 Kg
Uzunluğu	585mm
Devir	20000d/dk
Hava Girişi	1/4"

SM-519S

\$236,00

BANT ZIMPARA SETİ



Bant Ölçüsü	6-13mm
Ağırlığı	1,00 Kg
Uzunluğu	307mm
Devir	20000d/dk
Hava Girişi	1/4"
Set Muhteviyatı	3 adet Kafa ve Bant zımparalar

SM-6Z-6104K

\$258,50

Bant Ölçüsü	6-10-13-20mm
Ağırlığı	2,90 Kg
Uzunluğu	390mm
Devir	18000d/dk
Hava Girişi	1/4"
Set Muhteviyatı	5 adet Kafa ve Bant zımparalar

SM-6Z-6201K

\$281,60

BANT ZIMPARA

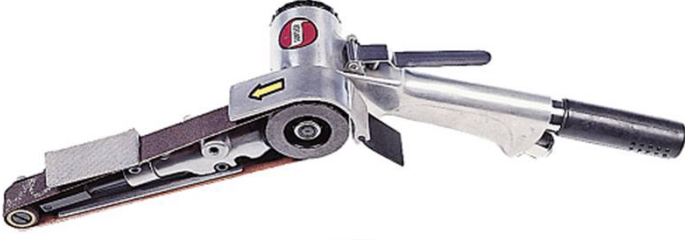

Bant Ölçüsü	13x610mm
Ağırlığı	0,80 Kg
Uzunluğu	600mm
Devir	16000d/dk
Hava Girişi	1/4"

SM-612

\$181,50

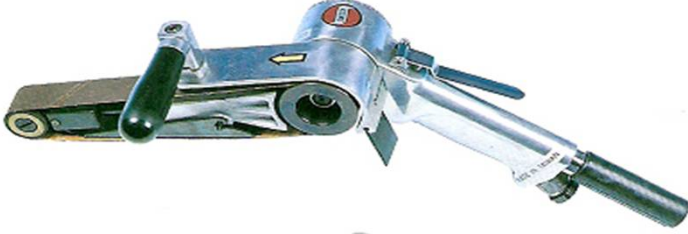

Bant Ölçüsü	20x520mm
Ağırlığı	1,40 Kg
Uzunluğu	300mm
Devir	16000d/dk
Hava Girişi	1/4"

SM-620

\$187,00



Bant Ölçüsü	10x330mm
Ağırlığı	0,85 Kg
Uzunluğu	207mm
Devir	20000d/dk
Hava Girişi	1/4"

Düşük ses

SM-6W-6100

\$140,80



Bant Ölçüsü	20x520mm
Ağırlığı	1,40 Kg
Uzunluğu	395mm
Devir	16000d/dk
Hava Girişi	1/4"

Düşük ses

SM-6T-6200

\$190,00

Bant Ölçüsü	30x540mm
Ağırlığı	2,20 Kg
Uzunluğu	400mm
Devir	12000d/dk
Hava Girişi	1/4"

Düşük ses

SM-6X-6300

\$316,80

YÜZEY TEMİZLEME



Ağırlığı	1,50 Kg
Uzunluğu	305mm
Devir	3500d/dk
Hava Girişi	1/4"

SM-6902

\$323,40

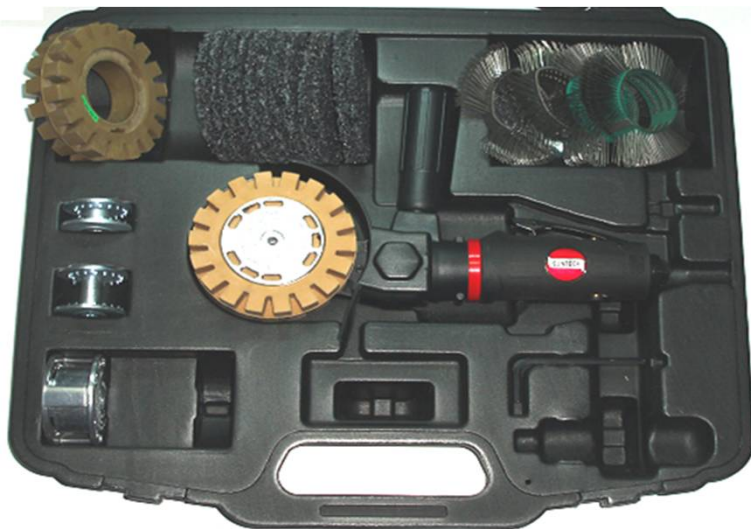

Ağırlığı	1,50 Kg
Uzunluğu	305mm
Devir	3500d/dk
Hava Girişi	1/4"

Set Muhteviyatı	11 parça Telleri, Silgileri ve göbekleri ile
-----------------	--

SM-6902K

\$437,80

YÜZEY TEMİZLEME

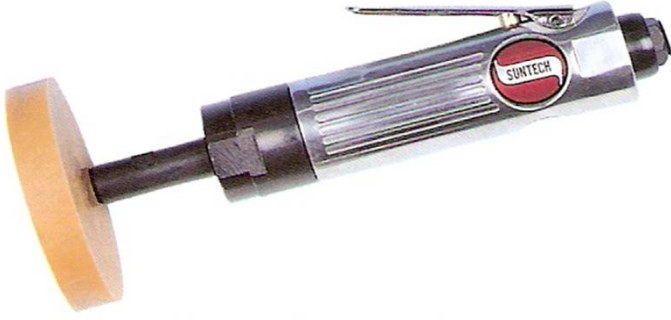

Disk Çapı	90mm
Ağırlığı	0,76 Kg
Uzunluğu	221mm
Devir	4000d/dk
Egzost	Arkadan
Hava Girişi	1/4"

SM-645

\$110,00

YÜZEY TEMİZLEME



Composite

Disk Çapı	90mm
Ağırlığı	0,95 Kg
Uzunluğu	226mm
Devir	4000d/dk
Egzost	Arkadan
Hava Girişi	1/4"

Kompozit
Gövde
Düşük ses

SM-6K-3011B

\$127,10

TESTERE

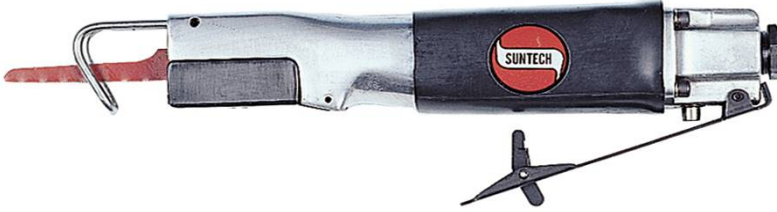

Kesme Kapasitesi	1,6mm
Ağırlığı	0,60 Kg
Uzunluğu	235mm
Devir	9000d/dk
Hava Girişi	1/4"

SG-0822

\$94,60

TESTERE



Kesme Kapasitesi	1,6mm
Ağırlığı	0,90 Kg
Uzunluğu	1000mm
Devir	8000d/dk
Hava Girişi	1/4"

Arkadan
Egzostlu

SG-0827

\$141,90

EĞE



Piston Stroku	9mm
Ağırlığı	1,00 Kg
Uzunluğu	178mm
Hava Girişi	1/4"

SG-0825

\$130,90

SAC MAKASI



Kesme Kapasitesi	1,8mm (Çelik)
Devir	2600d/dk
Ağırlığı	1,00 Kg
Uzunluğu	255mm
Hava Girişi	1/4"

SM-204S

\$96,80

SAC MAKASI



Kesme Kapasitesi	1,8mm (Çelik)
Devir	2600d/dk
Ağırlığı	2,25 Kg
Uzunluğu	210mm
Hava Girişi	1/4"

SM-204

\$96,80

NİBLİNG TİPİ SAC MAKASI



Kesme Kapasitesi	1,2mm (Çelik)
Ağırlığı	1,15 Kg
Uzunluğu	203mm
Hava Girişi	1/4"

SG-0821

\$84,70

POP PERÇİN MAKİNESİ



Kapasitesi	5mm
Ağırlığı	2,00 Kg
Uzunluğu	292mm
Hava Girişi	1/4"

SG-0810

\$93,50

Kapasitesi	5mm
Ağırlığı	2,00 Kg
Uzunluğu	292mm
Hava Girişi	1/4"

Set Muhteviyatı	Memeleri ve Tamir Takımları İle Birlikte
-----------------	--

SG-0810K

\$126,50

Ağır
Hizmet

Kapasitesi	6mm
Ağırlığı	2,10 Kg
Uzunluğu	320mm
Hava Girişi	1/4"

SG-0814

\$356,40

SOMUNLU PERÇİN MAKİNESİ

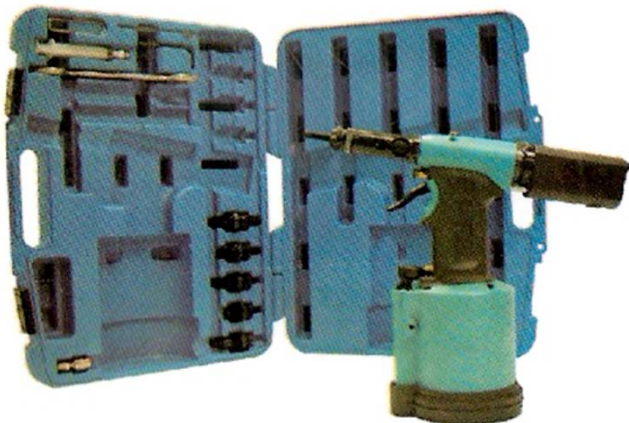

Kapasitesi	m4-5-6-8-12
Ağırlığı	2,95 Kg
Hava Girişi	1/4"

SM-HN-6000C

\$1.633,50

FİBER KESİCİ



Disk Çapı	75mm
Devir	20000d/dk
Ağırlığı	0,90 Kg
Uzunluğu	203mm
Hava Girişi	1/4"

SM-526

\$48,40

FİBER KESİCİ



Disk Çapı	75mm
Devir	18000d/dk
Ağırlığı	0,90 Kg
Uzunluğu	195mm
Hava Girişi	1/4"

Kompozit
Gövde
Düşük ses

SM-5265R

\$72,60

AVUÇ İÇİ ÇİVİ ÇAKMA



Kapasitesi	10mm
Boy	125mm
Ağırlığı	1,35 Kg
Hava Girişi	1/4"

SG-0125

\$156,20

AVUÇ İÇİ ÇEKİÇ



Boy	125mm
Ağırlığı	1,35 Kg
Hava Girişi	1/4"

SG-0126

\$156,20

VAKUMLU (KAPORTACI) ÇEKTİRME



Taban lastik çapı	120mm+150mm
Çekiç ağırlığı	1,40 Kg
Uzunluğu	600mm
Hava Girişi	1/4"

SM-202

\$211,80

SAC KIVIRMA VE PUNTA



Kapasitesi	5mm
Ağırlığı	1,90 Kg
Uzunluğu	255mm
Hava Girişi	1/4"

SG-0692

\$100,70

Kapasitesi	8mm
Ağırlığı	1,90 Kg
Uzunluğu	255mm
Hava Girişi	1/4"

SG-0693

\$134,20

CAM FİTİLİ (SİLİKONU) KESME



Hareket sayısı	20000d/dk
Strok	75mm
Ağırlığı	1,00 Kg
Uzunluğu	193mm
Hava Girişi	1/4"

SM-518

\$132,00

Hareket sayısı	20000d/dk
Strok	75mm
Ağırlığı	1,00 Kg
Uzunluğu	193mm
Hava Girişi	1/4"

SM-518K

Set Muhteviyatı	SM-518,1 Adet Bıçak,2 Adet 2'li Vantuz,1 Adet Taşıma Kayışı
-----------------	--

\$437,80

CAM FİTİLİ (SİLİKONU) KESME BIÇAKLARI



57mm

SA-51851

\$11,00

90mm

SA-51854

\$16,50



35mm

SA-51852

\$11,00



30mm

SA-51853

\$11,00



8mm

SA-51860

\$11,00



18mm

SA-51855

\$11,00

36mm

SA-51857

\$16,50

63mm

SA-51858

\$16,50

90mm

SA-51859

\$16,50



35mm

SA-51861

\$11,00



35mm

SA-51862

\$11,00

YAN KESKİ



Kapasitesi	0,5mm-Çelik 1,0mm-Bakır 2,0mm-Plastik
Ağırlığı	0,14 Kg
Uzunluğu	100mm
Hava Girişi	1/4"

SG-0823

\$108,90

Kapasitesi	1,0mm-Çelik 1,6mm-Bakır 4,0mm-Plastik
Ağırlığı	0,24 Kg
Uzunluğu	124mm
Hava Girişi	1/4"

SG-0824

\$115,00

DARBELİ YAZI YAZMA



Vuruş Adedi	3800bpm
Ağırlığı	0,20 Kg
Uzunluğu	171mm
Hava Girişi	1/4"

SG-0573

\$143,00

DARBELİ YAZI YAZMA



Uç Ölçüsü	1/8"
Vuruş Adedi	13500bpm
Piston Stroku	8,2mm
Piston Çapı	5,8mm
Ağırlığı	0,14 Kg
Uzunluğu	122mm
Hava Girişi	1/4"

SM-10-1001K

\$363,00

HAVŞA AÇMA

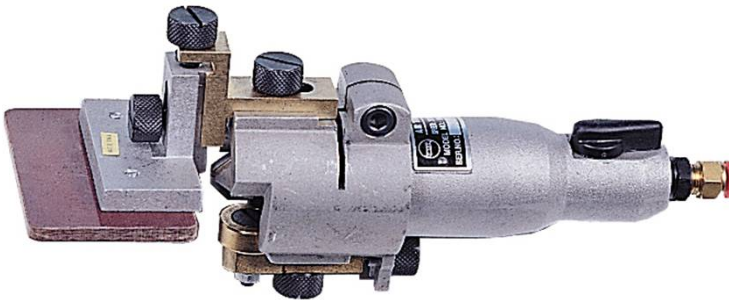

Devir	20000d/dk
Ağırlığı	1,80 Kg
Uzunluğu	228mm
Hava Girişi	1/4"

SM-205

\$220,00

ISKARPELA



Vuruş sayısı	4500d/dk
Piston Stroku	57mm
Ağırlığı	0,68 Kg
Uzunluğu	248mm
Hava Girişi	1/4"

SG-0815

\$61,60

ÇEKİÇ-KESKİ



Uç Giriş Çapı	10,4mm
Piston Stroku	41mm
Vuruş Adedi	5000bpm
Ağırlığı	1,35 Kg
Uzunluğu	134mm
Hava Girişi	1/4"

4 Adet
Ucuyla
Karton
Kutuda

SG-0101R/H

\$44,00

Uç Giriş Çapı	10,4mm
Piston Stroku	64mm
Vuruş Adedi	3200bpm
Ağırlığı	1,58 Kg
Uzunluğu	172mm
Hava Girişi	1/4"

SG-0204R/H

\$75,90

ÇEKİÇ-KESKİ



Uç Giriş Çapı	10,4mm
Piston Stroku	64mm
Vuruş Adedi	3200bpm
Ağırlığı	1,58 Kg
Uzunluğu	172mm
Hava Girişi	1/4"

5 Adet
Ucuyla
Plastik
Kutuda

SG-0204PSR

\$82,50

Uç Giriş Çapı	10,4mm
Piston Stroku	89mm
Vuruş Adedi	2000bpm
Ağırlığı	1,80 Kg
Uzunluğu	228mm
Hava Girişi	1/4"

SG-0304PSR

\$192,50

ÇEKİÇ-KESKİ-İĞNELİ KESKİ



Vuruş Adedi	3200bpm
Ağırlığı	2,16 Kg
Uzunluğu	343mm
İğne çapı/Adedi	3mm/ 19 adet
Hava Girişi	1/4"

SG-0204RNS

\$152,90

ÇEKİÇ-KESKİ



Vuruş Adedi	4000bpm
Ağırlığı	0,90 Kg
Uzunluğu	280mm
Hava Girişi	1/4"

SG-2288

\$96,80

ÇEKİÇ-KESKİ-İĞNELİ KESKİ



Vuruş Adedi	4000bpm
Ağırlığı	1,20 Kg
Uzunluğu	290mm
İğne çapı/Adedi	3mm/12 adet.
Hava Girişi	1/4"

SG-2288NS

\$112,80

ÇEKİÇ-KESKİ



Vuruş Adedi	4000bpm
Ağırlığı	1,58 Kg
Uzunluğu	406mm
Hava Girişi	1/4"

SG-0315

\$152,90

ÇEKİÇ-KESKİ-İĞNELİ KESKİ



Vuruş Adedi	4000bpm
Ağırlığı	2,60 Kg
Uzunluğu	416mm
İğne çapı/Adedi	3mm/ 19 adet
Hava Girişi	1/4"

SG-0315NS

\$221,70

ÇEKİÇ-KESKİ



Vuruş Adedi	4600bpm
Ağırlığı	1,35 Kg
Uzunluğu	368mm
Hava Girişi	1/4"

SG-9121

\$130,90

ÇEKİÇ-KESKİ-İĞNELİ KESKİ



Vuruş Adedi	4600bpm
Ağırlığı	2,50 Kg
Uzunluğu	381mm
İğne çapı/Adedi	3mm/ 19 adet
Hava Girişi	1/4"

SG-9121NS

\$247,50

ÇEKİÇ-KESKİ-İĞNELİ KESKİ



Vuruş Adedi	3000bpm
Ağırlığı	2,60 Kg
Uzunluğu	376mm
İğne çapı/Adedi	3mm/ 19 adet
Hava Girişi	1/4"

SG-2100NS

\$286,00

ÇEKİÇ-KESKİ-İĞNELİ KESKİ



Vuruş Adedi	3000bpm
Ağırlığı	2,60 Kg
Uzunluğu	315mm
İğne çapı/Adedi	3mm/ 19 adet
Hava Girişi	1/4"

SG-2110NS

\$178,20

ÇEKİÇ-KESKİ-İĞNELİ KESKİ



Vuruş Adedi	4500bpm
Ağırlığı	3,50 Kg
Uzunluğu	355mm
İğne çapı/Adedi	3mm/ 28 adet 4mm/ 14 adet
Hava Girişi	1/4"

SG-2280

\$363,00

ÇEKİÇ-KESKİ-İĞNELİ KESKİ



Vuruş Adedi	2200bpm
Ağırlığı	4,95 Kg
Uzunluğu	398mm
İğne çapı/Adedi	4mm/ 35 adet
Hava Girişi	1/4"

SG-2111NS

\$355,90

"S" TİPİ RASPA



Vuruş Adedi	8000bpm
Ağırlığı	1,90 Kg
Uzunluğu	115mm
Hava Girişi	1/4"

SG-2200

\$126,50

PERÇİN ÇEKİCİ



Uç Giriş Çapı	20mm
Piston Stroku	64mm
Vuruş Adedi	3000bpm
Ağırlığı	2,30 Kg
Uzunluğu	241mm
Hava Girişi	1/4"
Hortum Çapı	10mm

SG-0123R

\$209,00

Uç Giriş Çapı	28mm
Piston Stroku	25mm
Vuruş Adedi	2100bpm
Ağırlığı	6,50 Kg
Uzunluğu	368mm
Hava Girişi	3/8"
Hortum Çapı	13mm

SG-0122R1

\$319,00

Uç Giriş Çapı	28mm
Piston Stroku	50mm
Vuruş Adedi	1900bpm
Ağırlığı	6,80 Kg
Uzunluğu	394mm
Hava Girişi	3/8"
Hortum Çapı	13mm

SG-0122R2

\$396,00

Uç Giriş Çapı	28mm
Piston Stroku	100mm
Vuruş Adedi	1400bpm
Ağırlığı	8,10 Kg
Uzunluğu	464mm
Hava Girişi	3/8"
Hortum Çapı	13mm

SG-0122R4

\$453,20

Uç Giriş Çapı	28mm
Piston Stroku	75mm
Vuruş Adedi	1700bpm
Ağırlığı	7,20 Kg
Uzunluğu	413mm
Hava Girişi	3/8"
Hortum Çapı	13mm

SG-0122R3

\$429,00

PERÇİN ÇEKİCİ



Uç Giriş Çapı	28mm
Piston Stroku	64mm
Vuruş Adedi	2450bpm
Ağırlığı	7,30 Kg
Uzunluğu	305mm
Hava Girişi	3/8"
Hortum Çapı	13mm

SM-DR100V

\$459,80

Uç Giriş Çapı	28mm
Piston Stroku	76mm
Vuruş Adedi	2300bpm
Ağırlığı	7,70 Kg
Uzunluğu	356mm
Hava Girişi	3/8"
Hortum Çapı	13mm

SM-DR200V

\$484,00

Uç Giriş Çapı	28mm
Piston Stroku	95mm
Vuruş Adedi	2100bpm
Ağırlığı	8,40 Kg
Uzunluğu	387mm
Hava Girişi	3/8"
Hortum Çapı	13mm

SM-DR300V

\$508,20

Uç Giriş Çapı	28mm
Piston Stroku	108mm
Vuruş Adedi	1700bpm
Ağırlığı	8,90 Kg
Uzunluğu	419mm
Hava Girişi	3/8"
Hortum Çapı	13mm

SM-DR400V

\$526,40

BETON KIRICI



Uç Giriş Çapı	32x152mm
Piston Çapı	57,15mm
Piston Stroku	100mm
Vuruş Adedi	1400bpm
Ağırlığı	30 Kg
Uzunluğu	645mm
Hava Girişi	3/4"
Hortum Çapı	19mm

SM-P612

\$1.512,50

Uç Giriş Çapı	32x152mm
Piston Çapı	66,67mm
Piston Stroku	152mm
Vuruş Adedi	1250bpm
Ağırlığı	42 Kg
Uzunluğu	723mm
Hava Girişi	3/4"
Hortum Çapı	19mm

SM-P912

\$1.705,00

GRES TABANCASI



Kapasitesi	500cc
Hava Girişi	1/4"

SG-843

\$31,90

Kapasitesi	500cc
Hava Girişi	1/4"

SG-843K

Set muhteviyatı	El Pompa Aparatı İle
-----------------	----------------------

\$42,40

KUMLAMA TABANCASI



Tipi	Torbalı model
Hava Girişi	1/4"

SG-9171

\$42,40

VAKUM VE TEMİZLİK TABANCASI



Hava Girişi	1/4"
-------------	------

SG-1222

\$27,50

SİLİKON TABANCASI



Tipi	Kartuş silikon
Hava Girişi	1/4"

SG-9907

\$26,40

MOTOR YIKAMA



Hava Girişi | 1/4"

SG-1070

\$14,90

BOYA TABANCASI



Meme Ölçüsü | 1,4mm
Depo | Üstten-Plastik

SG-1048

\$126,00

BOYA TABANCASI



Meme Ölçüsü | 1,5mm
Depo | Üstten-Metal

SG-1042

\$113,90

BOYA TABANCASI



Meme Ölçüsü | 1,6mm
Depo | Alttan-Metal

SG-1046

\$96,80

MAZOT TABANCASI



Hava Girişi | 1/4"
Depo | Metal

SG-1057

\$42,40

LASTİÇE HAVA BASMA



ST-712

\$5,00



Saatli

ST-725

\$18,20

METAL HAVA TABANCASI



Kısa-Metal
SG-1062
\$13,20



Uzun-Metal
SG-1064L
\$14,90

PLASTİK HAVA TABANCASI



Kısa-Plastik
SG-1072
\$5,00



Uzun-Plastik
SG-1072L
\$9,90

METAL HAVA TABANCASI



Kısa-Metal
SG-1063
\$6,10

PLASTİK HAVA TABANCASI



Kısa-Plastik
SG-1065
\$7,70

MİNİ FİLTRE

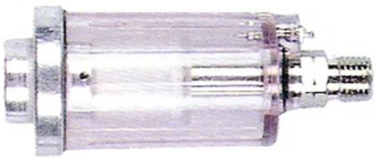

1/4"
G-302
\$9,40

MİNİ REGÜLATÖR



1/4"
SG-9052
\$5,00

MİNİ YAĞLAYICI



1/4"
G-301
\$9,40

MAFSALLI RAKOR



1/4" ve 3/8"
SA-14/38
\$13,20

ŞARTLANDIRICI (HAVA HAZIRLAYICI)



Şartlandırıcı
1/2"

SG-070012

\$77,60



Filirte Regülatör
1/2"

SB-2041

\$66,60



Filitre
1/2"

SB-1141

\$24,20



Regülatör
1/2"

SB-1241

\$30,30



Yağlayıcı
1/2"

SB-1341

\$24,20

YÜZEY TEMİZLEME TELİ



Düz Tel 11mm

SA-0511

\$14,30

Düz Tel 23mm

SA-0523

\$14,30



Eğri Tel 11mm

SA-0711

\$14,30

Eğri Tel 23mm

SA-0723

\$14,30

YÜZEY TEMİZLEME TELİ GÖBEK ADAPTÖRÜ



Adaptör 11mm

SA-6902WH

\$18,60

Adaptör 23mm

SA-6902RH

\$18,60

YÜZEY TEMİZLEME SİLGİSİ



SA-6902RW

\$22,00

YÜZEY TEMİZLEME SÜNGERİ



SA-6902BW

\$7,70

CAM VANTUZU, TAŞIMA KAYIŞI VE SETİ



2'li Tek Vantuz

SM-911

\$65,50



Cam Taşıma Kayışı

SM-911NH

\$14,90

2 ad. 2'li Vantuz
Taşıma Kayışı

SM-911KNH

\$145,20

SPİRAL HAVA HORTUMLARI



POLIÜRETAN

Hortum Ölçüsü 5x8mm 7,5mt
Bağlantı 1/4"-Rakorlu

SA-225PU

\$5,50

Hortum Ölçüsü 5x8mm 15mt
Bağlantı 1/4"-Rakorlu

SA-250PU

\$9,90

Hortum Ölçüsü 6,5x9,5mm 7,5mt
Bağlantı 3/8"-Rakorlu

SA-325PU

\$8,80

Hortum Ölçüsü 6,5x9,5mm 15mt
Bağlantı 3/8"-Rakorlu

SA-350PU

\$16,50

Hortum Ölçüsü 8x12mm 7,5mt
Bağlantı 3/8"-Rakorlu

SA-807PU

\$12,10

Hortum Ölçüsü 8x12mm 15mt
Bağlantı 3/8"-Rakorlu

SA-812PU

\$23,10



POLIÜRETAN

Hortum Ölçüsü 5x8mm 7,5mt
Bağlantı Kaplinli

SA-225PUK

\$13,20

Hortum Ölçüsü 5x8mm 15mt
Bağlantı Kaplinli

SA-250PUK

\$17,60

Hortum Ölçüsü 6,5x9,5mm 7,5mt
Bağlantı Kaplinli

SA-325PUK

\$16,50

Hortum Ölçüsü 6,5x9,5mm 15mt
Bağlantı Kaplinli

SA-350PUK

\$24,20



PVC

Hortum Ölçüsü 5x8mm 15mt
Bağlantı 1/4"-Rakorlu

SA-250

\$10,20

PUNTA ÇÜRÜTME UÇLARI



5-6-8mm

SA-72151-5/6/8

\$14,90

SAC KESME YEDEK KAFASI



SA-204/204S

\$48,40

LASTİK TAŞLAMA ŞİPŞAK KAFASI



SA-0661

\$24,20

HAVALI YANKESKİ YEDEĞİ



S-2
(SG-0823)

\$72,60

S-4
(SG-0824)

\$78,70

HAVALI KESKİ YEDEĞİ



4'lü

SG-1304R/H

\$6,50

6'lı

SG-1306R/H

\$20,90

HAVALI KALIPÇI TAŞLAMA PENSİ



3-6mm

\$5,00

HAVALI KESKİ TUTUCU YAYI



SA-0101S

\$6,60

HAVALI TESTERE YEDEĞİ



SA-18/24/32S

\$2,20

HAVALI KESKİ TUTUCU KAFASI



G-102

\$12,10

HAVALI EĞE YEDEĞİ



4'lü Takım

SA-0825S

\$29,20

İSTİNAT (ZIMPARA) DİSKİ



115mm

\$7,70

HAVALI RASPA İĞNESİ



3-4mm

N.307-3/4

\$0,70

HAVALI KÖŞE ZIMPARA YEDEĞİ



SA-518

\$34,10

ZIMPARA TABANI

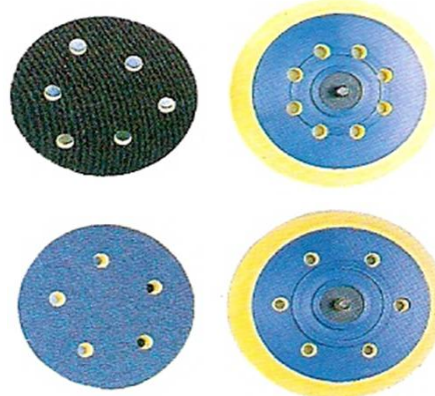

150mm-6 Delikli

CIRTLI

\$8,80

150mm-6 Delikli

YAPIŞKANLI

\$7,70

YAYLI BALANSERLER



Kapasite 5,00-9,00 Kg
Halat Boyu 130cm

SB-9K

\$146,30

Kapasite 9,00-15,00 Kg
Halat Boyu 130cm

SB-15K

\$170,50

Kapasite 15,00-22,00 Kg
Halat Boyu 150cm

SB-22K

\$192,50

Kapasite 22,00-30,00 Kg
Halat Boyu 150cm

SB-30K

\$198,00

Kapasite 30,00-40,00 Kg
Halat Boyu 150cm

SB-40K

\$242,00

Kapasite 40,00-50,00 Kg
Halat Boyu 150cm

SB-50K

\$258,50

Kapasite 50,00-60,00 Kg
Halat Boyu 150cm

SB-60K

\$271,70

Kapasite 60,00-70,00 Kg
Halat Boyu 150cm

SB-70K

\$291,50

Kapasite 70,00-80,00 Kg
Halat Boyu 150cm

SB-80K

\$302,50

Kapasite 70,00-90,00 Kg
Halat Boyu 200cm

SB-90K

\$308,00

Kapasite 80,00-100,00 Kg
Halat Boyu 200cm

SB-100K

\$495,00

Kapasite 105,00-120,00 Kg
Halat Boyu 200cm

SB-120K

\$517,00

Kapasite 0,50-1,00 Kg
Halat Boyu 130cm

SB-1,5K

\$46,20

Kapasite 1,50-3,00 Kg
Halat Boyu 130cm

SB-3K

\$96,80

Kapasite 3,00-5,00 Kg
Halat Boyu 130cm

SB-5K

\$108,90



YAYLI BALANSERLER



Kapasite	0,60-1,50 Kg
Halat Boyu	90cm

SB-1200

\$8,80

Kapasite	1,00-2,00 Kg
Halat Boyu	90cm

SB-2000

\$8,80

Kapasite	1,00-3,00 Kg
Halat Boyu	90cm

SB-3000

\$11,00

Kapasite	3,00-5,00 Kg
Halat Boyu	90cm

SB-5000

\$14,30

HORTUMLU BALANSERLER



Kapasite	1,50 Kg
Hortum Ölçüsü	5x8mm
Hortum Boyu	130cm

LR-09

\$64,90

Kapasite	1,50-3,00 Kg
Hortum Ölçüsü	6,5x10mm
Hortum Boyu	140cm

TAB-3N

\$74,80

Kapasite	3,00-5,00 Kg
Hortum Ölçüsü	6,5x10mm
Hortum Boyu	140cm

TAB-5N

\$85,80

HAVA REELLERİ



Hortum ölçüsü	6,50 x 9,50mm
Hortum boyu	6mt

HR-600

\$76,50

Hortum ölçüsü	5,00 x 8,00mm
Hortum boyu	7,50mt

HR-750

\$76,50

KUIK KAPLIN GÖVDE

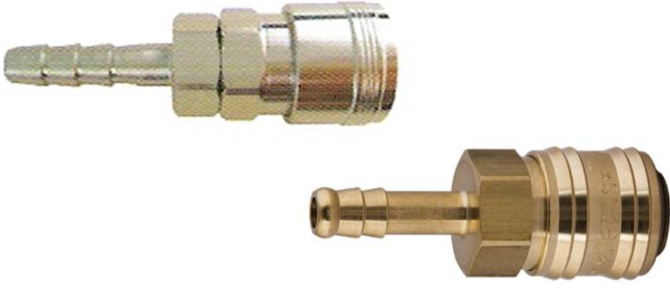

20-SH	1/4"-9mm
30-SH	3/8"-11mm
40-SH	1/2"-15mm

GÖVDE

\$5,00

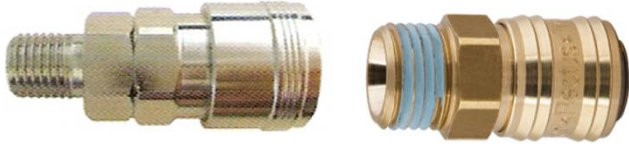

20-SM	1/4"
30-SM	3/8"
40-SM	1/2"

GÖVDE

\$5,00



20-SF	1/4"
30-SF	3/8"
40-SF	1/2"

GÖVDE

\$5,00

KUIK KAPLIN RAKOR



20-PH	1/4"-9mm
30-PH	3/8"-11mm
40-PH	1/2"-15mm

RAKOR

\$2,80



20-PM	1/4"
30-PM	3/8"
40-PM	1/2"

RAKOR

\$2,80



20-PF	1/4"
30-PF	3/8"
40-PF	1/2"

RAKOR

\$2,80

ÇOKLU KUIK KAPLINLER



SMV-2'li Gövde
1/2"-15mm

2'Lİ GÖVDE

\$18,20

1 ad.SMV Gövde
2 ad. Rakor

TAKIM

\$23,70



SMY-3'lü Gövde
1/2"-15mm

3'LÜ GÖVDE

\$29,20

1 ad.SMY Gövde
3 ad. Rakor

TAKIM

\$37,60



SMM-4'lü Gövde
1/2"-15mm

4'LÜ GÖVDE

\$46,00

1 ad.SMM Gövde
4 ad. Rakor

TAKIM

\$57,20

SOMUN SIKMA-SÖKMELERİN DARBE MEKANİZMALARI



Darbe pimli çekiç sistemi



Gözlük çekiç sistemi



Tek çekiç sistemi



Çift çekiç sistemi



SH

AIR TOOLS



1/2" KABZALI MİNİ SOMUN SIKMA-SÖKME



Soket	1/2"
Max.Torku	55kg/m
Ağırlığı	1,60 Kg
Devir	8500d/dk
Çekiç Sistemi	Tekli gözlük çekiç
Hava Girişi	1/4"

SH-7277

\$53,00

1/2" KABZALI SOMUN SIKMA-SÖKME



Soket	1/2"
Max.Torku	150kg/m
Ağırlığı	2,00 Kg
Devir	8000d/dk
Çekiç Sistemi	İkiz gözlük çekiç
Hava Girişi	1/4"

Composit
Gövde
Düşük ses

SH-7304

\$58,00

3/4" KABZALI SOMUN SIKMA-SÖKME



Soket	3/4"
Max.Torku	200kg/m
Ağırlığı	8,00 Kg
Devir	4300d/dk
Çekiç Sistemi	İkiz gözlük çekiç
Hava Girişi	1/2"

SH-7310

\$118,00

1" KABZALI SOMUN SIKMA-SÖKME



Soket	1"
Max.Torku	240kg/m
Ağırlığı	9,98 Kg
Devir	5000d/dk
Çekiç Sistemi	Pimli çeliç
Hava Girişi	1/2"

SH-7880

\$157,00



AIR TOOLS

AIR ACCESSORIES

Most Complete, Competent and Knowledgeable Supplier for You

www.steedtools.com

NINGBO STEED TOOLS CO., LTD.

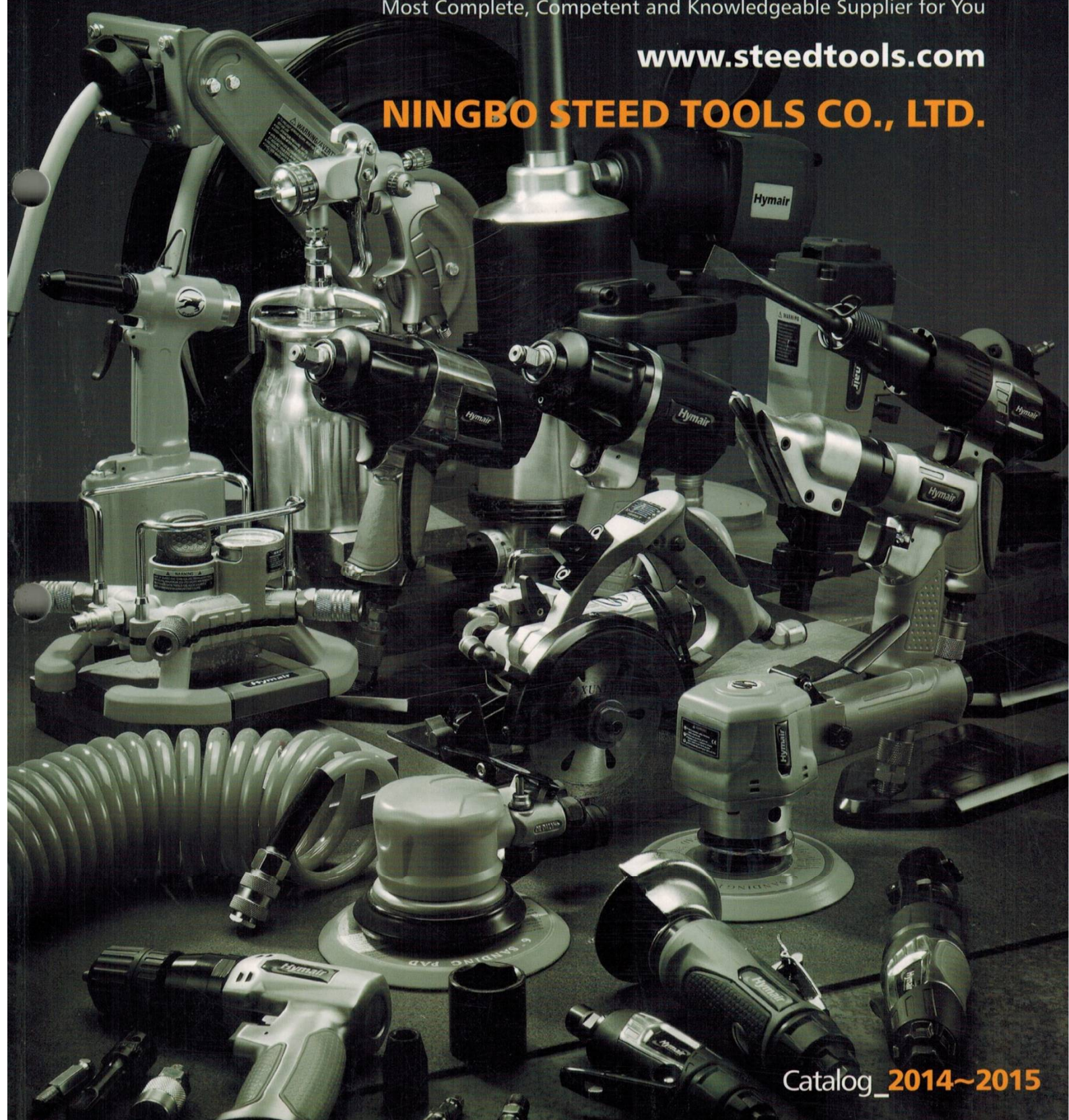

Catalog_2014~2015

3/8" KELEBEK SOMUN SIKMA-SÖKME



Soket	3/8"
Max.Torku	10kg/m
Ağırlığı	0,90 Kg
Uzunluğu	160x85mm
Devir	10000d/dk
Çekiç Sistemi	Tek çekiç
Hava Girişi	1/4"



AT-5030

\$36,20

3/8" KABZALI SOMUN SIKMA-SÖKME



Soket	3/8"
Max.Torku	18kg/m
Ağırlığı	1,19 Kg
Uzunluğu	172x136mm
Devir	9000d/dk
Çekiç Sistemi	Tek çekiç
Hava Girişi	1/4"



AT-5031

\$36,20

3/8" KABZALI SOMUN SIKMA-SÖKME



Soket	3/8"
Max.Torku	34kg/m
Ağırlığı	1,50 Kg
Uzunluğu	180x160mm
Devir	8000d/dk
Çekiç Sistemi	İkiz gözlük çekiç
Hava Girişi	1/4"



PAT-103

\$59,90

1/2" KABZALI MİNİ SOMUN SIKMA-SÖKME



(F/R Power switch)

Soket	1/2"
Max.Torku	68kg/m
Ağırlığı	1,61 Kg
Uzunluğu	180x130mm
Devir	10000d/dk
Çekiç Sistemi	İkiz gözlük çekiç
Hava Girişi	1/4"



**Hafif-Küçük
Güçlü Model**

MINI

NST-500M

\$90,40

1/2" KABZALI SOMUN SIKMA-SÖKME



Soket	1/2"
Max.Torku	34kg/m
Ağırlığı	2,18 Kg
Uzunluğu	205x200mm
Devir	7000d/dk
Çekiç Sistemi	Tek çekiç
Hava Girişi	1/4"



AT-5040

\$38,50

SET	m9,10,11,13,14 17,19,22,24,27 Lokmalar +Uzatma
-----	--

AT-5004

\$49,80

1/2" KABZALI SOMUN SIKMA-SÖKME



Soket	1/2"
Max.Torku	68kg/m
Ağırlığı	2,79 Kg
Uzunluğu	195x193mm
Devir	7000d/dk
Çekiç Sistemi	İkiz gözlük çekiç
Hava Girişi	1/4"



AT-239

\$66,70

SET	m10,11,13,14,17 19,22,24 Lokmalar +Uzatma
-----	---

AT-239K

\$84,80

1/2" KABZALI SOMUN SIKMA-SÖKME



(FIR Power switch)

Ağır Hizmet Tipi

Soket	1/2"
Max.Torku	115kg/m
Ağırlığı	2,55 Kg
Uzunluğu	205x205mm
Devir	6800d/dk
Çekiç Sistemi	İkiz gözlük çekiç
Hava Girişi	1/4"



AT-T1252C

\$128,90

3/4" KABZALI SOMUN SIKMA-SÖKME



Soket	3/4"
Max.Torku	68kg/m
Ağırlığı	4,45 Kg
Uzunluğu	247x240mm
Devir	4500d/dk
Çekiç Sistemi	Tek çekiç
Hava Girişi	1/4"



AT-261

\$90,40

3/4" KABZALI SOMUN SIKMA-SÖKME



Soket	3/4"
Max.Torku	130kg/m
Ağırlığı	2,60 Kg
Uzunluğu	242x235mm
Devir	5000d/dk
Çekiç Sistemi	İkiz gözlük çekiç
Hava Girişi	3/8"



AT-272

\$197,80

3/4" KABZALI SOMUN SIKMA-SÖKME



Soket	3/4"
Max.Torku	160kg/m
Ağırlığı	6,80 Kg
Uzunluğu	266x242mm
Devir	4200d/dk
Çekiç Sistemi	İkiz gözlük çekiç
Hava Girişi	3/8"

Ağır Hizmet Tipi



AT-265

\$206,80

1" KABZALI SOMUN SIKMA-SÖKME



Ağır Hizmet
Tipi

Soket	1"
Max.Torku	160kg/m
Ağırlığı	6,80 Kg
Uzunluğu	266x242mm
Devir	4200d/dk
Çekiç Sistemi	İkiz gözlük çekiç
Hava Girişi	3/8"



AT-266

\$243,00

1" DÜZ TİP SOMUN SIKMA-SÖKME



Soket	1"-Uzun
Max.Torku	320kg/m
Ağırlığı	16,50 Kg
Uzunluğu	582x185mm
Devir	3200d/dk
Çekiç Sistemi	Pimli çekiç
Hava Girişi	1/2"



AT-9981

\$444,10

1" DÜZ TİP SOMUN SIKMA-SÖKME



Soket	1"-Kısa
Max.Torku	220kg/m
Ağırlığı	12,70 Kg
Uzunluğu	350x185mm
Devir	3900d/dk
Çekiç Sistemi	Pimli çekiç
Hava Girişi	1/2"



AT-4500A

\$327,70

1" DÜZ TİP SOMUN SIKMA-SÖKME



Soket	1"-Uzun
Max.Torku	220kg/m
Ağırlığı	13,40 Kg
Uzunluğu	550x185mm
Devir	3900d/dk
Çekiç Sistemi	Pimli çekiç
Hava Girişi	1/2"



AT-4500

\$327,70

1" DÜZ TİP SOMUN SIKMA-SÖKME



Soket	1"-Uzun
Max.Torku	380kg/m
Ağırlığı	19,00 Kg
Uzunluğu	659x180mm
Devir	3300d/dk
Çekiç Sistemi	Pimli çekiç
Hava Girişi	1/2"



AT-4600

\$339,00

1" DÜZ TİP SOMUN SIKMA-SÖKME

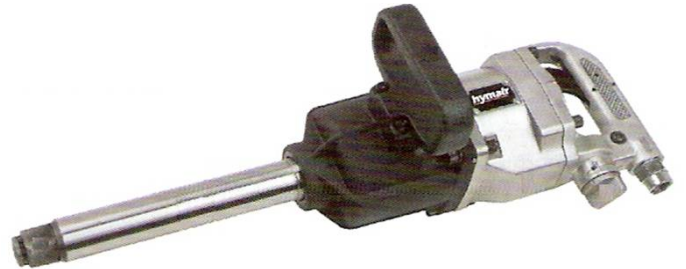

Soket	1"-Uzun
Max.Torku	280kg/m
Ağırlığı	12,00 Kg
Uzunluğu	510x180mm
Devir	3200d/dk
Çekiç Sistemi	İkiz gözlük çekiç
Hava Girişi	1/2"



AT-8200

\$469,00

1" DÜZ TİP SOMUN SIKMA-SÖKME

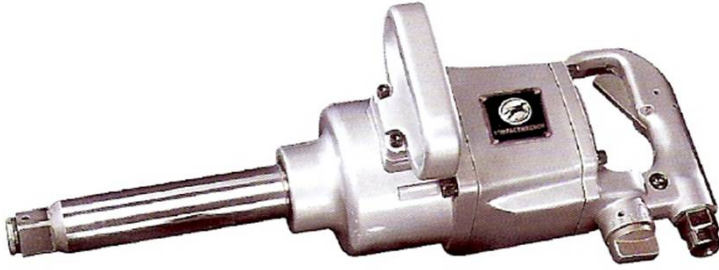

Soket	1"-Kısa
Max.Torku	190kg/m
Ağırlığı	10,53 Kg
Uzunluğu	350mm
Devir	3500d/dk
Çekiç Sistemi	Pimli çekiç
Hava Girişi	1/2"



AT-285-7

\$293,80

Soket	1"-Uzun
Max.Torku	190kg/m
Ağırlığı	12,60 Kg
Uzunluğu	510mm
Devir	3500d/dk
Çekiç Sistemi	Pimli çekiç
Hava Girişi	1/2"

AT-285-6

\$293,80

1/4" CIRCİR



Soket	1/4"
Max.Torku	2,7kg/m
Ağırlığı	0,51 Kg
Uzunluğu	170x53mm
Devir	230d/dk
Hava Girişi	1/4"

AT-5055N

\$36,20

3/8"-1/2" CIRCİR



Soket	3/8"
Max.Torku	7kg/m
Ağırlığı	1,13 Kg
Uzunluğu	263x53mm
Devir	160d/dk
Hava Girişi	1/4"

AT-5057

\$33,90

Soket	1/2"
Max.Torku	7kg/m
Ağırlığı	1,13 Kg
Uzunluğu	263x53mm
Devir	160d/dk
Hava Girişi	1/4"

AT-5056

\$33,90

1/2" CIRCİR



Soket	1/2"
Max.Torku	8,5kg/m
Ağırlığı	1,22 Kg
Uzunluğu	275x57mm
Devir	160d/dk
Hava Girişi	1/4"

AT-5059A

\$61,10

KALIPÇI TAŞLAMA



Pens Ölçüsü	6mm
Ağırlığı	0,38 Kg
Uzunluğu	148x60mm
Devir	25000d/dk
Egzost	Arkadan
Hava Girişi	1/4"

AT-7032

\$17,00

Pens Ölçüsü	6mm
Ağırlığı	0,60 Kg
Uzunluğu	168x68mm
Devir	22000d/dk
Egzost	Arkadan
Hava Girişi	1/4"

AT-7033

\$17,00

SET	10 adet muhtelif Saplı taş 3-6mm Pens Rakor
-----	--

AT-7033K

\$22,60

KALIPÇI TAŞLAMA



Pens Ölçüsü	6mm
Ağırlığı	0,38 Kg
Uzunluğu	148x60mm
Devir	25000d/dk
Egzost	Arkadan
Hava Girişi	1/4"

AT-7032B

\$19,30

Pens Ölçüsü	6mm
Ağırlığı	0,60 Kg
Uzunluğu	168x68mm
Devir	22000d/dk
Egzost	Arkadan
Hava Girişi	1/4"

AT-7033B

\$19,30

SET	10 adet muhtelif Saplı taş 3-6mm Pens Rakor
-----	--

AT-7033BK

\$29,40

MİKRO KALIPÇI TAŞLAMA



16 parçalı set	
Pens Ölçüsü	3mm
Devir	35000d/dk
Egzost	Arkadan
Hava Girişi	1/4"

AT-3000K

\$52,00

KALIPÇI TAŞLAMA VE KESME SETİ



Pens Ölçüsü	3mm
Ağırlığı	0,20 Kg
Uzunluğu	134x16mm
Devir	54000d/dk
Egzost	Arkadan
Hava Girişi	1/4"

AT-3170

\$29,40

SET	10 adet muhtelif Saplı taş Mini yağlayıcı Rakor
-----	--

AT-010K

\$33,90

KALIPÇI TAŞLAMA VE KESME SETİ



22 parçalı set	
Pens Ölçüsü	6mm
Taş Çapı	76mm
Ağırlığı	0,78 Kg
Uzunluğu	185x80mm
Devir	22000d/dk
Egzost	Arkadan
Hava Girişi	1/4"

AT-012BK

\$52,00

90° KALIPÇI TAŞLAMA



Pens Ölçüsü	6mm
Ağırlığı	0,53 Kg
Uzunluğu	154x78mm
Devir	20000d/dk
Egzost	Arkadan
Hava Girişi	1/4"

AT-7034

\$33,90

UZUN TİP KALIPÇI TAŞLAMA



Pens Ölçüsü	6mm
Ağırlığı	1,31 Kg
Uzunluğu	338x70mm
Devir	22000d/dk
Egzost	Arkadan
Hava Girişi	1/4"

AT-7033LB

\$37,30

METALE YAZI YAZMA



Vuruş Adedi	13000bpm
Ağırlığı	0,39 Kg
Uzunluğu	173x68mm
Hava Girişi	1/4"

AT-3190P

\$67,80

LASTİK TAŞLAMA



Uç Tipi	Şipşaklı
Ağırlığı	0,97 Kg
Uzunluğu	212x68mm
Devir	2500d/dk
Egzost	Arkadan
Hava Girişi	1/4"

AT-7070B

\$45,20

LASTİK TAŞLAMA



Uç Tipi	Şipşaklı
Ağırlığı	0,97 Kg
Uzunluğu	212x68mm
Devir	2500d/dk
Egzost	Arkadan
Hava Girişi	1/4"

AT-7070C

\$50,90

DÜZ TİP SHUT-OFF'LU TORNAVİDA



Uç Ölçüsü	1/4"
Kapasitesi	4mm
Ağırlığı	0,68 Kg
Uzunluğu	238x50mm
Devir	1000d/dk
Hava Girişi	1/4"

AT-4055

\$96,10

DÜZ TİP TORNAVİDA



Uç Ölçüsü	1/4"
Kapasitesi	4mm
Ağırlığı	0,67 Kg
Uzunluğu	203x50mm
Devir	1500d/dk
Hava Girişi	1/4"

AT-4050

\$44,10

DÜZ TİP DARBELİ TORNAVİDA



Uç Ölçüsü	1/4"
Kapasitesi	5mm
Ağırlığı	0,70 Kg
Uzunluğu	195x60mm
Devir	12000d/dk
Hava Girişi	1/4"

AT-W5

\$44,10

MİKRO TİP 4mm MATKAP



17 parçalı set	
Mandren	4mm
Devir	35000d/dk
Egzost	Arkadan
Hava Girişi	1/4"

AT-3100K

\$56,50

10mm DÜZ TİP MATKAP



Mandren	10mm
Dönüş	Sağ
Ağırlığı	0,90 Kg
Uzunluğu	210x68mm
Devir	2500d/dk
Hava Girişi	1/4"

AT-4038

\$30,60

10mm KABZALI MATKAP



Mandren	10mm
Dönüş	Sağ-Sol
Ağırlığı	1,11 Kg
Uzunluğu	183x142mm
Devir	1800d/dk
Hava Girişi	1/4"

AT-4031

\$45,20

10mm KABZALI MATKAP



Mandren	10mm
Dönüş	Sağ-Sol
Ağırlığı	1,48 Kg
Uzunluğu	185x155mm
Devir	2200d/dk
Hava Girişi	1/4"

Ağır Hizmet
Elle Sıkmalı
Plastik
Mandren

PAT-401KL

\$50,90

13mm KABZALI MATKAP



Mandren	13mm
Dönüş	Sağ-Sol
Ağırlığı	1,62 Kg
Uzunluğu	223x150mm
Devir	700d/dk
Hava Girişi	1/4"

AT-4041B

\$49,80

YÜZEY TEMİZLEME



Disk çapı	87mm
Ağırlığı	0,97 Kg
Uzunluğu	226x93mm
Devir	4000d/dk
Egzost	Arkadan
Hava Girişi	1/4"

Yedek Diski

\$11,30

AT-7036B

\$54,30

100mm SATIŞ TAŞLAMA



Taş Çapı	100mm
Diş Ölçüsü	3/8x24UNF
Ağırlığı	1,38 Kg
Uzunluğu	185x120mm
Devir	11000d/dk
Hava Girişi	1/4"

AT-282

\$67,80

125mm SATIŞ TAŞLAMA



Taş Çapı	125mm
Diş Ölçüsü	3/8x24UNF
Ağırlığı	1,75 Kg
Uzunluğu	223x140mm
Devir	11000d/dk
Hava Girişi	1/4"

Ağır Hizmet

AT-285B

\$101,70

180mm SATIH TAŞLAMA



Taş Çapı	180mm
Diş Ölçüsü	5/8x11BSW
Ağırlığı	3,06 Kg
Uzunluğu	310x240mm
Devir	8400d/dk
Hava Girişi	1/4"

Ağır Hizmet

AT-782

\$167,30

150mm YATAY TİP SATIH TAŞLAMA



Taş Çapı	150mm
Ağırlığı	5,00 Kg
Uzunluğu	485mm
Devir	6600d/dk
Hortum Girişi	16mm

Ağır Hizmet
Yatay Tip

AT-150Z66A

\$327,70

DAİRESEL ZIMPARA



Disk Çapı	180mm
Ağırlığı	1,90 Kg
Uzunluğu	370x171mm
Devir	4500d/dk
Hava Girişi	1/4"

AT-880A

\$99,50

EKSANTRİK DAİRESEL ZIMPARA



Disk Çapı	150mm
Eksantrik	5mm
Ağırlığı	1,06 Kg
Uzunluğu	175x143mm
Devir	9000d/dk
Hava Girişi	1/4"

AT-980

\$61,10

Disk Çapı	150mm
Eksantrik	5mm
Ağırlığı	1,06 Kg
Uzunluğu	175x143mm
Devir	9000d/dk
Hava Girişi	1/4"

Toz Emişli

AT-980V

\$72,40

EKSANTRİK DAİRESEL ZIMPARA



Disk Çapı	150mm
Eksantrik	5mm
Ağırlığı	1,74 Kg
Uzunluğu	255x143mm
Devir	10000d/dk
Hava Girişi	1/4"

AT-280

\$45,20

SULU TİP DAİRESEL ZIMPARA



Disk çapı	125mm
Ağırlığı	3,90 Kg
Uzunluğu	277x102mm
Devir	6000d/dk
Hava Girişi	1/4"

Sulu Tip

AT-185WL

\$149,00

SET	19 Parçalı
-----	------------

AT-185WL-K

\$271,20

SULU TİP DAİRESEL ZIMPARA



Disk çapı	125mm
Ağırlığı	3,96 Kg
Uzunluğu	257x102mm
Devir	5500d/dk
Hava Girişi	1/4"

Sulu Tip

AT-185WH

\$125,00

SET	17 Parçalı
-----	------------

AT-185WH-K

\$196,70

EKSANTRİK TİTREŞİMLİ ZIMPARA

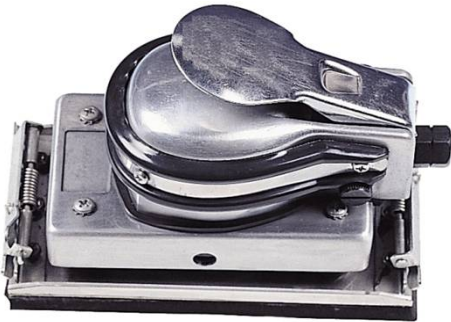

Taban Ölçüsü	95x175mm
Eksantrik	5mm
Ağırlığı	1,89 Kg
Uzunluğu	187x125mm
Devir	8000d/dk
Hava Girişi	1/4"

AT-7018

\$45,20

RENDE ZIMPARA

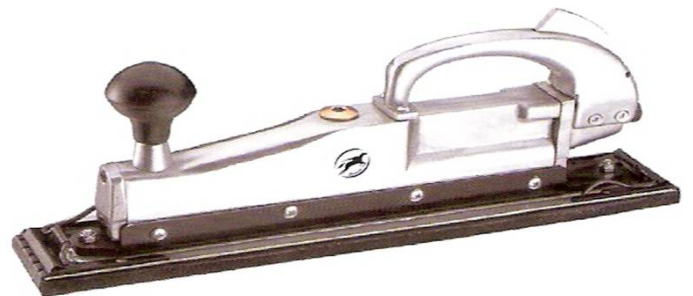

Taban Ölçüsü	64x407mm
Strok	25mm
Ağırlığı	2,56 Kg
Uzunluğu	400x170mm
Devir	2500d/dk
Hava Girişi	1/4"

AT-186

\$61,10

SULU TİP ZIMPARA POLİSAJ



Disk çapı	180mm
Diş ölçüsü	5/8x11UNC
Ağırlığı	4,34 Kg
Uzunluğu	365x113mm
Devir	4500d/dk
Hava Girişi	1/4"

Sulu Tip

AT-880AW-R

\$249,00

BANT ZIMPARA



Bant Ölçüsü	10x330mm
Ağırlığı	0,78 Kg
Uzunluğu	280x75mm
Devir	16000d/dk
Hava Girişi	1/4"

AT-480

\$72,40

SULU TİP TAŞ, MERMER ve KARO KESME

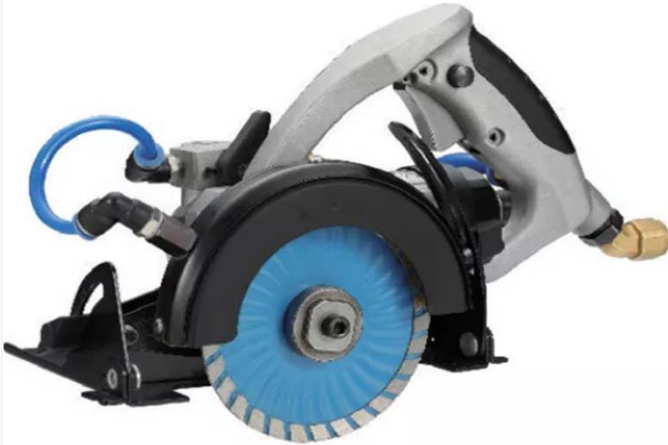

Disk çapı	100mm
Kapasitesi	30mm
Kesme açısı	45 dereceye kadar
Ağırlığı	2,92 Kg
Uzunluğu	330mm
Devir	7000d/dk
Hava Girişi	1/4"

Sulu Tip

AT-600W

\$145,80

AĞIR HİZMET POP PERÇİN PENSESİ



Kapasitesi	6mm
Çekme Gücü	850kgs
Strok	14mm
Ağırlığı	1,66 Kg
Uzunluğu	225x93mm
Hava Girişi	1/4"

AT-6017

\$107,40

DÖKÜMCÜ TOKMAKLARI (KUM SIKIŞTIRMA)



Mil Çapı-Strok	25mm-100mm
Ağırlığı	6,00 Kg
Uzunluğu	950-1095mm
Vuruş Adedi	900bpm
Hortum Girişi	1/2"

AT-D6

\$266,70

Mil Çapı-Strok	32mm-120mm
Ağırlığı	9,50 Kg
Uzunluğu	1140-1380mm
Vuruş Adedi	900bpm
Hortum Girişi	1/2"

AT-D9

\$322,10

TESTERE



Kesme kap./Çelik	1,6mm
/Alüminyum	2mm
Strok Hareketi	10000s/dk
Ağırlığı	0,64 Kg
Uzunluğu	235x70mm
Hava Girişi	1/4"

AT-7039

\$47,50

EĞELEME ve TESTERE



Piston Stroku	5mm
Strok Hareketi	3400s/dk
Ağırlığı	0,50 Kg
Uzunluğu	163x62mm
Hava Girişi	1/4"

Arkadan
Egzost

AT-6070

\$152,60

CAM FİTİLİ (SİLİKONU) KESME

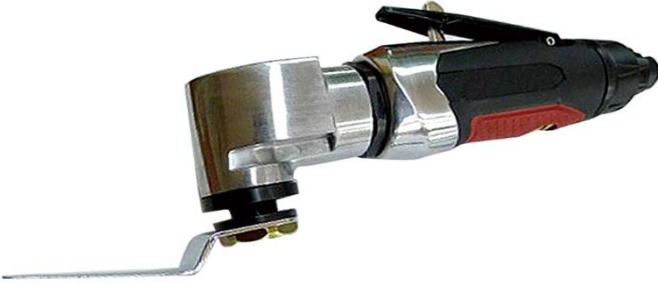

Devir/Strok	20000d/dk/75mm
Ağırlığı	0,89 Kg
Uzunluğu	257mm
Hava Girişi	1/4"

AT-9039

\$49,80

İĞNE UÇLU KABZALI KESKİ



İğne Çapı / Ad.	3mm/23 adet
Vuruş Adedi	4500bpm
Ağırlığı	2,70 Kg
Uzunluğu	360mm
Hava Girişi	1/4"

AT-XC23

\$186,50

ÇEKİÇ-KESKİ



Piston Çapı	19mm
Piston Stroku	41mm
Vuruş Adedi	4500bpm
Ağırlığı	1,13 Kg
Uzunluğu	170x145mm
Hava Girişi	1/4"

4 adet
ucuyla

AT-
2010R-K

\$39,60

Piston Çapı	19mm
Piston Stroku	66mm
Vuruş Adedi	3000bpm
Ağırlığı	1,45 Kg
Uzunluğu	220x145mm
Hava Girişi	1/4"

4 adet
ucuyla

AT-
2020RSG-K

\$50,90

İĞNE UÇLU KABZALI KESKİ



İğne Çapı / Ad.	3mm/19 adet
Piston Stroku	24mm
Vuruş Adedi	4500bpm
Ağırlığı	1,95 Kg
Uzunluğu	342x145mm
Hava Girişi	1/4"

AT-8039D

\$84,80

İĞNE UÇLU DÜZ KESKİ



İğne Çapı / Ad.	3mm/12 adet
Piston Stroku	24mm
Vuruş Adedi	2800bpm
Ağırlığı	1,10 Kg
Uzunluğu	215x80mm
Hava Girişi	1/4"

AT-8039

\$55,40

İĞNE UÇLU DÜZ KESKİ



İğne Çapı / Ad.	3mm/19 adet
Piston Stroku	40mm
Vuruş Adedi	4600bpm
Ağırlığı	2,79 Kg
Uzunluğu	465x77mm
Hava Girişi	1/4"

AT-8039P

\$149,20

LASTİK TAMİR (DÖVME) ALETİ



Piston Stroku	66mm
Vuruş Adedi	3000bpm
Ağırlığı	1,45 Kg
Uzunluğu	220x145mm
Hava Girişi	1/4"

AT-7036ESG

\$62,20

BETON KIRICI



Silindir Çapı	38mm
Ağırlığı	10,00 Kg
Uzunluğu	570mm
Hava Girişi	13mm

AT-G10

\$194,40

MAZOT TABANCASI



WG-02

\$33,90

MOTOR YIKAMA



J109

\$13,60

BOYA TABANCASI



Meme Ölçüsü	1,8mm
Depo	Alttan-Metal
2 kademeli tetik, Hafif Alüminyum	
Ayarlanabilir püskürtme genişliği	
Ayarlı akışkan çıkışı ve hava girişi	
Kaymayı önleyici kontrol düğmesi	

AS-4001

\$42,00

BOYA KARIŐTIRMA

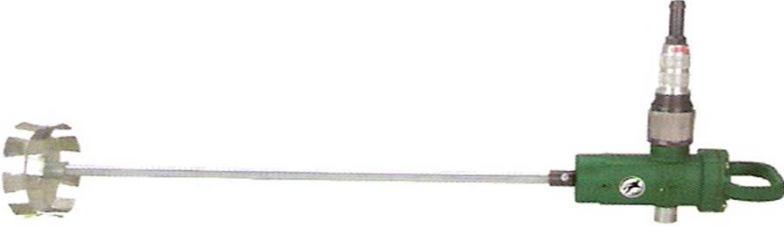

Kafa apı	100mm
Ađırlığı	3,00 Kg
Uzunluđu	600mm
Devir	2000d/dk
Hortum GiriŐi	13mm

AT-TJ3

\$311,90

ŐARTLANDIRICI (HAVA HAZIRLAYICI)

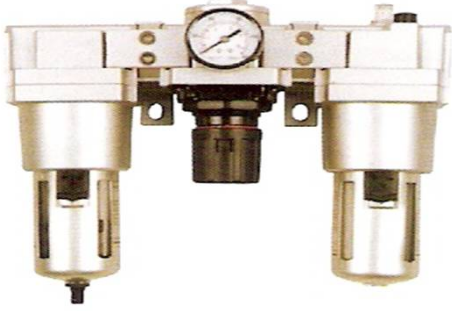

1/2"

4000-04D

\$50,90

1"

5000-10D

\$135,60

GRES TABANCASI



Kapasitesi	500cc
Ađırlığı	1,32 Kg
Uzunluđu	395x370mm
Hava GiriŐi	1/4"

AT-6036

\$24,90

SET

El pompa aparatı
ile birlikte

AT-6036-6

\$33,40

TEMİZLİK SETİ



7 para, Mini sprge, Hava tab.
Basıncılı su tabancası, Lastik ŐiŐirme,
Spiral hortum, Fira ve Eldiven

AK-10

\$50,90

SİLİKON TABANCASI



Ađırlığı	0,92 Kg
Uzunluđu	290x168mm
Hava GiriŐi	1/4"

AT-193

\$24,90

İBRE GÖSTERGELİ LASTİK ŐİŐİRME



TG-31L

\$47,50



TG-02

\$17,00

KAPORTACI SETİ



7 para
ekik
Dayama

HD-100

\$101,70



ENDO



ERP SERİSİ YAYLI BALANSER



Kapasite 0,30-0,60 Kg
Halat Boyu 1,50mt

ERP-06E

€ 105,90

Kapasite 0,50-1,00 Kg
Halat Boyu 1,50mt

ERP-1

€ 113,00

Kapasite 1,00-2,00 Kg
Halat Boyu 1,30mt

ERP-2

€ 130,60

EK-EW SERİSİ YAYLI BALANSER



Kapasite 0,50-1,50 Kg
Halat Boyu 0,50mt

EK-00

€ 83,60

Kapasite 0,50-1,50 Kg
Halat Boyu 1,00mt

EK-0

€ 137,70

Kapasite 1,00-3,00 Kg
Halat Boyu 1,30mt

EW-3

€ 231,80

EWS SERİSİ YAYLI BALANSER



Kapasite 1,50-3,00 Kg
Halat Boyu 1,30mt

EWS-3

€ 265,90

Kapasite 3,00-5,00 Kg
Halat Boyu 1,30mt

EWS-5

€ 284,70

Kapasite 5,00-7,00 Kg
Halat Boyu 1,30mt

EWS-7

€ 337,70

EWF SERİSİ YAYLI BALANSER



Kapasite 4,50-9,00 Kg
Halat Boyu 1,30mt

EWF-9

€ 484,70



Kapasite 9,00-15,00 Kg
Halat Boyu 1,30mt

EWF-15

€ 515,30

Kapasite 15,00-22,00 Kg
Halat Boyu 1,50mt

EWF-22

€ 814,10

ETP SERİSİ YAYLI BALANSER



Kapasite 120,00-140,00 Kg
Halat Boyu 1,20mt

ETP-14

€ 2.855,20

Kapasite 140,00-170,00 Kg
Halat Boyu 1,20mt

ETP-15

€ 3.311,60

Kapasite 170,00-200,00 Kg
Halat Boyu 1,20mt

ETP-16

€ 3.514,00

Kapasite 22,00-30,00 Kg
Halat Boyu 1,50mt

EWF-30

€ 856,50

Kapasite 30,00-40,00 Kg
Halat Boyu 1,50mt

EWF-40

€ 1.157,60

Kapasite 40,00-50,00 Kg
Halat Boyu 1,50mt

EWF-50

€ 1.203,50

Kapasite 50,00-60,00 Kg
Halat Boyu 1,50mt

EWF-60

€ 1.324,70

Kapasite 60,00-70,00 Kg
Halat Boyu 1,50mt

EWF-70

€ 1.394,10

Kapasite 70,00-90,00 Kg
Halat Boyu 2,00mt

EWF-90

€ 2.188,20

Kapasite 85,00-105,00 Kg
Halat Boyu 2,00mt

EWF-105

€ 2.371,70

Kapasite 100,00-120,00 Kg
Halat Boyu 2,00mt

EWF-120

€ 2.568,10



KALIPÇI TAŞLAMA



Devir	65000d/dk
Pens Ölçüsü	3mm
Tipi	Kalem tip
Ölçüleri	161x16,7mm
Ağırlığı	130gr

MSG-3BSN

\$470,00

KALIPÇI TAŞLAMA



Devir	65000d/dk
Pens Ölçüsü	3mm
Tipi	Kalem tip
Ölçüleri	165x22mm
Ağırlığı	78gr

FX3.0

\$423,00

KALIPÇI TAŞLAMA



Devir	23500d/dk
Tipi	Kalem tip 45 derece
Ölçüleri	142x48x32mm
Ağırlığı	175gr

MAG-123.N

\$500,00

KALIPÇI TAŞLAMA



Devir	23500d/dk
Tipi	Kalem tip 90 derece
Ölçüleri	138x41x33mm
Ağırlığı	160gr

MAG-093.N

\$500,00

SAĞ-SOL HAREKETLİ EĞELEME



Devir	56000d/dk
Strok	0,3mm
Ölçüleri	218x28mm
Ağırlığı	180gr

TLS-03

\$625,00

Devir	20000d/dk
Strok	0,7mm
Ölçüleri	218x28mm
Ağırlığı	180gr

TLS-07

\$625,00

Devir	14000d/dk
Strok	1,2mm
Ölçüleri	218x28mm
Ağırlığı	180gr

TLS-12

\$625,00

İLERİ-GERİ HAREKETLİ EĞELEME



Devir	52000d/dk
Strok	0,3mm
Ölçüleri	218x28mm
Ağırlığı	180gr

TLL-03

\$625,00

Devir	28000d/dk
Strok	0,7mm
Ölçüleri	218x28mm
Ağırlığı	180gr

TLL-07

\$625,00

Devir	19000d/dk
Strok	1,2mm
Ölçüleri	218x28mm
Ağırlığı	180gr

TLL-12

\$625,00

KALIPÇI TAŞLAMA



Devir	52500d/dk
Tipi	Kalem tip 120 derece
Ölçüleri	142x55x17mm
Ağırlığı	140gr

MAG-121.N

\$517,00



PCL



İBRE GÖSTERGELİ LASTİK ŞİŞİRME



Max.Giriş Basıncı	13,8bar / 200psi
Şişirme Basıncı	0-9,6bar 0-138psi
Okuma Aralığı	0,1bar / 2psi
Hortum Boyu	0,53m

**AIRFORCE MK4
AFG4H03**

€ 82,50

Max.Giriş Basıncı	27bar / 392psi
Şişirme Basıncı	3-21bar 45-300psi
Okuma Aralığı	0,25bar / 5psi
Hortum Boyu	1,80m

**AIRFORCE MK4
AFG6H041**

€ 165,00

İBRE GÖSTERGELİ LASTİK ŞİŞİRME



Max.Giriş Basıncı	15bar / 218psi
Şişirme Basıncı	0-12bar 0-170psi
Okuma Aralığı	0,1bar / 2psi
Hortum Boyu	1,80m

**AIRFORCE
AFG1H08**

€ 82,50

DİJİTAL GÖSTERGELİ LASTİK ŞİŞİRME



Max.Giriş Basıncı	16bar / 232psi
Şişirme Basıncı	0-12bar 0-174psi
Okuma Aralığı	0,1bar / 2psi
Hortum Boyu	1,80m

**ACCURA 1
DTI08**

€ 110,00

DİJİTAL GÖSTERGELİ LASTİK ŞİŞİRME



Max.Giriş Basıncı	17,2bar / 250psi
Şişirme Basıncı	0,3-17bar 4-250psi
Okuma Aralığı	0,1bar / 2psi
Hortum Boyu	0,53m

**ACCURA MK4
DAC403**

€ 93,50

DİJİTAL LASTİK DİŞ KUMPASI



Dijital, lastik diş derinlik ölçüm
kumpası

DTD61D04

€ 16,50



Dijital, lastik diş derinlik ölçüm
kumpası+Lastik basınç ölçme

DTP67

€ 17,60



TORNADOR

INNOVATED AIR/WATER CLEANING TOOL

- QUICK & EASY TO USE
- IDEAL FOR HARD TO CLEAN AREAS
- CLEANS CRACKS & CREVICES LIKE NEVER BEFORE
- CLEANS & AIR DRIES IN SECONDS
- ENERGIZES PRODUCT FOR QUICK ACTION CLEANING
- JUST AIR & TURBO CLEANER[®] PRODUCT NEEDED
- SAVES TIME & MONEY
- RUGGED CONSTRUCTION
- EASY TO MAINTAIN



PATENT PENDING

QUICKLY CLEANS AND AIR DRIES...



CARPETS & UPHOLSTERY...



VENTS...



HARD TO REACH AREAS...



CRACKS AND CREVICES

TORNADOR

OTO TEMİZLİK TABANCASI



Hava ile çalışan bu temizlik tabancası zamandan %70 sarfiyattan ise %90'a varan tasarruf sağlamaktadır. Yapısı itibarıyla otomobilin tavan, taban, kapı, yer döşemesi, plastik, vinil ve motor parçalarını çok kısa sürede temizlemenizi sağlar.

TORNADOR

Classic Z-010

\$220,00



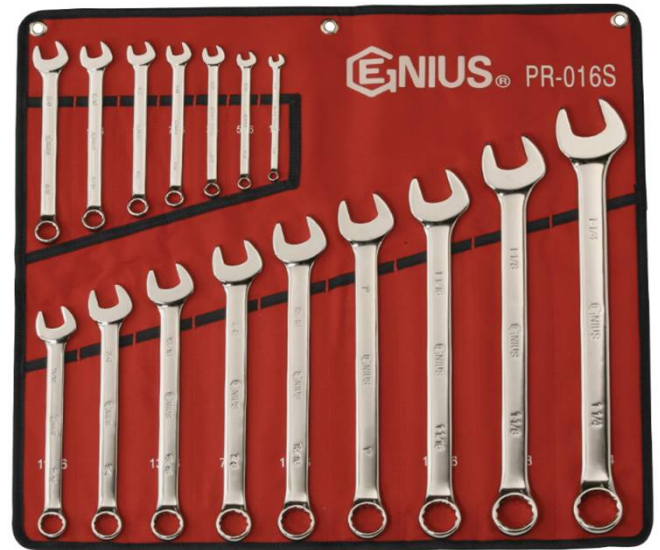
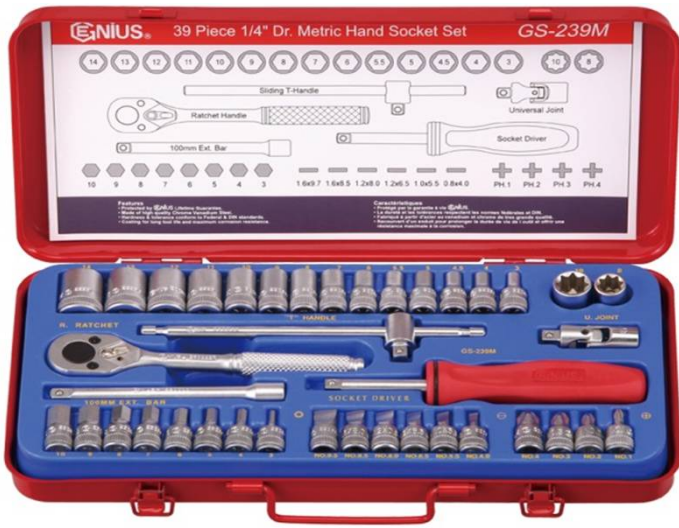

HAVALI LOKMA TAKIMI

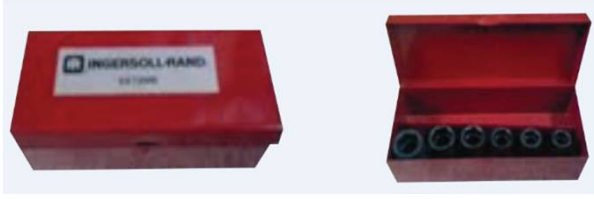

3/8"	KISA	SS-72MB
6 p.	ALTIKÖŞE: 8-13mm	\$26,80

Kısa Lokma: m8-9-10-11-12-13



1/2"	KISA	GS-409M
9 p.	ALTIKÖŞE: 11-22mm	\$38,80

Kısa Lokma: m11-12-13-14-16-17-19-21-22



3/4"	KISA	CM-022 CM-608M
8 p.	ALTIKÖŞE: 26-38mm	\$107,60

Kısa Lokma: m26-27-29-30-32-35-36-38

3/4"	KISA	CM-021
8 p.	ALTIKÖŞE: 1"-1.1/2"	\$128,80

Kısa Lokma: 1"-1.1/16-1.1/8-1.1/4-1.5/16-1.3/8-1.7/16-1.1/2

1"	KISA	CM-110 CM-809M
9 p.	ALTIKÖŞE: 24-50mm	\$190,70

Kısa Lokma: m24-27-30-32-35-38-41-46-50

1"	KISA	CM-029
9 p.	ALTIKÖŞE: 1"-2"	\$239,30

Kısa Lokma: 1-1.1/8-1.1/4-1.3/8-1.1/2-1.5/8-1.3/4-1.7/8-2

HAVALI LOKMA TAKIMI



3/8"	UZUN	TD-308M
8 p.	ALTIKÖŞE: 8-19mm	\$59,00

Kısa Lokma: m8-10-11-12-13-14-17-19



1/2"	UZUN	TF-008-1 TD-410M1
10 p.	ALTIKÖŞE: 10-24mm	\$71,70

Uzun Lokma: m10-12-13-14-16-17-19-21-22-24

3/4"	UZUN	CM-608M4 CD-608M4
8 p.	ALTIKÖŞE: 27-41mm KARE: 19-21mm	\$190,70

Uzun Lokma: m27-30-32-35-38-41

Uzun Kare lokma: m19-21

HAVALI LOKMA TAKIMI



1/2"	KISA	GS-417
17 p.	ALTIKÖŞE: 8-30mm	\$70,30

Kısa Lokma: m8-9-10-11-12-13-14-15-16-17-18-19-21-22-24-27-30

3/4"	KISA	IS-609E
9 p.	ALTIKÖŞE: 19-36mm	\$117,10

Kısa Lokma: m19-22-24-27-30-32-33-34-36

3/4"	KISA	IS-617E
17 p.	ALTIKÖŞE: 19-55mm	\$263,80

Kısa Lokma: m19-21-22-24-27-30-32-33-34-35-36-38-40-41
46-50-55

3/4"	KISA	IS-617M
17 p.	ALTIKÖŞE: 26-46mm	\$180,00

Kısa Lokma: m26-27-28-29-30-31-32-33-34-35-36-37-38-40-41-43-46

1"	KISA	IS-817S
17 p.	ALTIKÖŞE: 1.7/16-3.1/8	\$963,30

Kısa Lokma: 1,7/16-1,1/2-1,5/8-1,11/16-1,3/4-1,13/16-1,7/8
2"-2,1/8-2,3/16-2,1/4-2,3/8-2,1/2-2,5/8-2,3/4-2,15/16-3,1/8

3/4"	KISA	IS-617S
17 p.	ALTIKÖŞE: 1"-2"	\$327,90

Kısa Lokma: 1-1,11/16-1,1/8-1,3/16-1,1/4-1,5/16-1,3/8-1,7/16
1,1/2-1,9/16-1,5/8-1,11/16-1,3/4-1,13/16-1,7/8-1,15/16-2

HAVALI LOKMA TAKIMI



3/4"	UZUN	DI-621M
21 p.	ALTIKÖŞE: 19-50mm	\$488,90

Uzun Lokma: m19-21-22-23-24-27-29-30-32-33-35-36-38-40
41-42-43-45-46-48-50

HAVALI LOKMA TAKIMI



1/2"	KISA	TF-416M
16 p.	ALTIKÖŞE: 8-27mm	\$114,80

Kısa Lokma: m8-10-11-12-13-14-16-17-19-21-22-24-27
Cırcır kol (1)-Mafsal kol (1)-Uzatma (1)

ALTIKÖŞE KROMAJLI LOKMA TAKIMI



1/4"

KISA-UZUN

GS-244MS

44 p.

ALTIKÖŞE: 3-14mm
ALTIKÖŞE: 3/16"-9/16"

\$70,20

Kısa Lokma: m3-4-5-5,5-6-7-8-9-10-11-12-143-14
3/16-7/32-1/4-9/32-5/16-11/32-3/8-7/16-1/2-9/16
Uzun Lokma: m5,5-6-7-8-9-10-11-12-13-14
1/4-9/32-5/16-11/32-3/8-7/16-1/2-9/16
Circir kol (1)-Uzatma (2)

ALTIKÖŞE KROMAJLI LOKMA TAKIMI

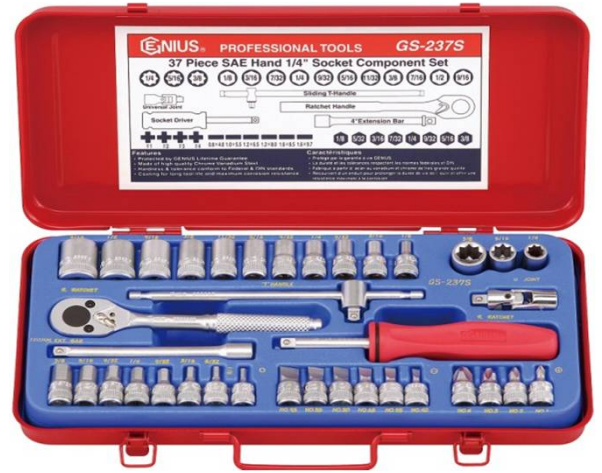

1/4"

KISA

GS-237S

37 p.

ALTIKÖŞE: 1/8"-9/16"
KARE: 1/4"-3/8"

\$63,80

Kısa Lokma: 1/8-3/16-7/32-1/4-9/32-5/16-11/32-3/8-7/16
1/2-9/16
Kare lokma: 1/4-5/16-3/8
Lokmalı düz uç (6)-Lokmalı Yıldız uç (4)-Lokmalı allen uç (8)
T kolu (1)-Uzatma (1)-Lokma sapı (1)-Circir kol (1)-Ara mafsal (1)

ALTIKÖŞE KROMAJLI LOKMA TAKIMI

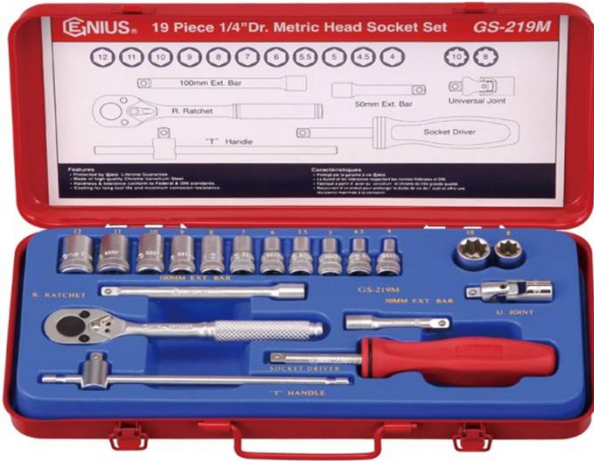

1/4"

KISA

GS-219M

19 p.

ALTIKÖŞE: 4-12mm
KARE: 8-10mm

\$49,90

Kısa Lokma: m4-4,5-5-5,5-6-7-8-9-10-11-12
Kare Lokma: m8-10 Circir kol (1)
T kolu (1)-Uzatma (2)-Lokma sapı -(1)Ara mafsal (1)

1/4"

KISA

GS-220M

20 p.

ALTIKÖŞE: 3-12mm
KARE: 8-10mm

\$55,70

Kısa Lokma: m3-4-4,5-5-5,5-6-7-8-9-10-11-12
Kare Lokma: m8-10 Circir kol (1)
T kolu (1)-Uzatma (2)-Lokma sapı (1)-Ara mafsal (1)-Mafsal kol (1)

ALTIKÖŞE KROMAJLI LOKMA TAKIMI



1/4"

KISA-UZUN

GS-255MS

55 p.

ALTIKÖŞE: 3-14mm
ALTIKÖŞE: 1/8"-9/16"

\$104,40

Kısa Lokma: m3-4-4,5-5-5,5-6-7-8-9-10-11-12-13-14
1/8-3/16-7/32-1/4-9/32-5/16-11/32-3/8-7/16-1/2-9/16
Uzun Lokma: m4-4,5-5-5,5-6-7-8-9-10-11-12-13-14
3/16-7/32-1/4-9/32-5/16-11/32-3/8-7/16-1/2-9/16
Uzatma (4)-Ara mafsal (1)-Adaptör (1)-Uç Ad.(1)

ALTIKÖŞE KROMAJLI LOKMA TAKIMI



1/4"	KISA	EU-228M
28 p.	ALTIKÖŞE: 4-13mm	\$65,00

Kısa Lokma: m4-5-5,5-6-7-8-9-10-11-12-13
 Düz Uç: m4-6-7 Yıldız Uç: Ph1-2-3 Allen Uç: m3-4-5-6
 Bits uç adaptörü (1)
 T kolu (1)-Uzatma (2)-Lokma sapı (1)
 Mafsal (1)-Circir kol (1)-Ara mafsal (1)

1/4"	KISA	EU-228S
28 p.	ALTIKÖŞE: 1/8"-9/16"	\$69,60

Kısa Lokma: 1/8-3/16-7/32-1/4-9/32-5/16-11/32-3/8-7/16-1/2-9/16
 Düz Uç: m4-6-7 Yıldız Uç: Ph1-2-3 Allen Uç: 1/8-5/32-3/16-7/32
 Bits uç adaptörü (1)
 T kolu (1)-Uzatma (2)-Lokma sapı (1)
 Mafsal (1)-Circir kol (1)-Ara mafsal (1)

ALTIKÖŞE KROMAJLI LOKMA TAKIMI

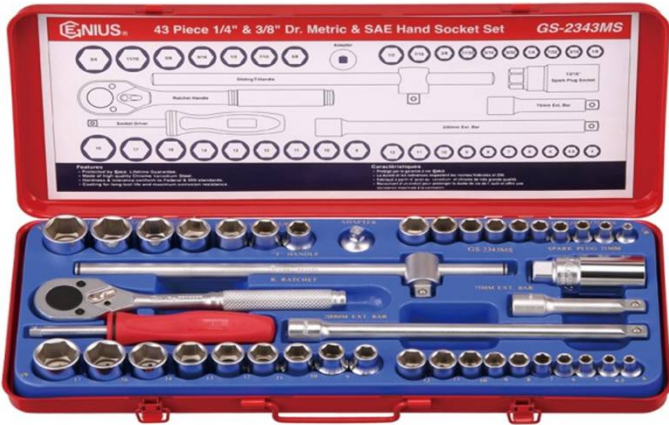

ALTIKÖŞE KROMAJLI LOKMA TAKIMI



1/4"	KISA-UZUN	GS-221M
21 p.	ALTIKÖŞE: 5-13mm	\$37,20

Kısa Lokma: m5-5,5-6-7-8-9-10-11-12-13
 Uzun Lokma: m6-7-8-9-10-11-12-13
 Circir kol (1)-Uzatma (1)-Lokma sapı (1)

ALTIKÖŞE KROMAJLI LOKMA TAKIMI

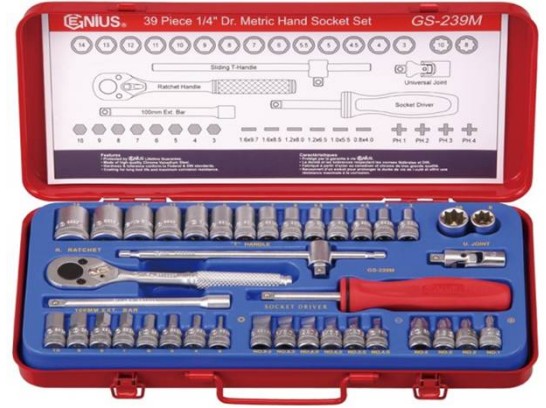

1/4"	KISA	GS-239M
39 p.	ALTIKÖŞE: 3-14mm KARE: 8-10mm	\$68,50

Kısa Lokma: m3-4-4,5-5-5,5-6-7-8-9-10-11-12-13-14
 Kare lokma: m8-10
 Lokmalı düz uç (6)-Lokmalı Yıldız uç (4)-Lokmalı allen uç (8)
 T kolu (1)-Uzatma (1)-Lokma sapı (1)-Circir kol (1)-Ara mafsal (1)

1/4" 3/8"	KISA	GS-2343MS
43 p.	ALTIKÖŞE: 4-19mm ALTIKÖŞE: 1/8"-3/4"	\$100,20

1/4" Kısa Lokma: m4-4,5-5-6-7-8-9-10-11-12
 1/8-3/16-7/32-1/4-9/32-5/16-11/32-3/8-7/16-1/2
 3/8" Kısa Lokma: m9-10-11-12-13-14-16-17-19
 3/8-7/16-1/2-9/16-5/8-11/16-3/4
 T kolu (1)-Uzatma (2)-Lokma sapı (1)
 Circir kol (1)-Adaptör (1)-Buji lokması (1)

YILDIZ KROMAJLI LOKMA TAKIMI

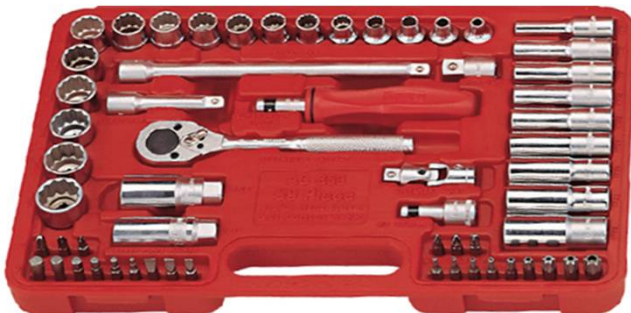

3/8"	KISA-UZUN	AC-359
59 p.	YILDIZ: 6-22mm	\$113,50

Kısa Lokma: m6-7-8-9-10-11-12-13-14-15-16-17-18-19-20-21-22
 Uzun Lokma: m8-10-11-12-13-14-15-17-19
 Allen bits uç (6)-Yıldız bits uç (6)-Düz bits u (3)
 Delikli torx bits uç (9)-Uç adp.(1)
 Uzatma (2)-Bits uç sapı (1)-Circir kol (1)
 Adaptör (1)-Buji lokması (2)-Ara mafsal (1)

YILDIZ KROMAJLI LOKMA TAKIMI



3/8"

UZUN

TW-316MD

16 p.

YILDIZ: 6-21mm

\$63,80

Uzun Lokma: m6-7-8-9-10-11-12-13-14-15-16-17-18-19-20-21

ALTIKÖŞE KROMAJLI LOKMA TAKIMI

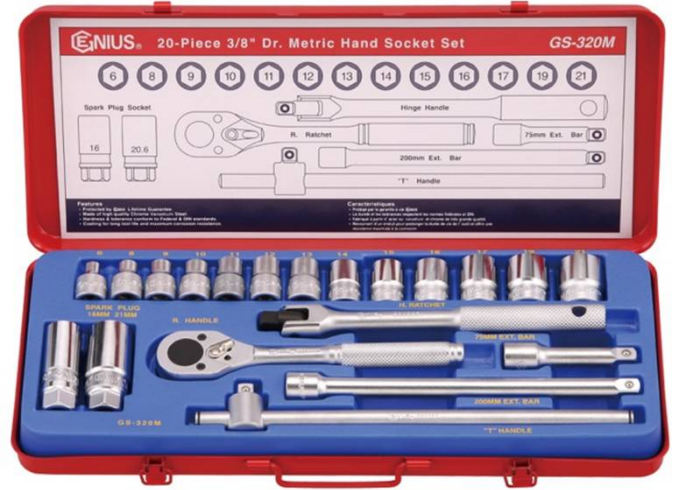

3/8"

KISA

GS-320M

20 p.

ALTIKÖŞE: 6-21mm

\$102,80

Kısa Lokma: m6-8-9-10-11-12-13-14-15-16-17-19-21

Circir kol (1)-Uzatma (2)-T kolu (1)-Mafsal kol (1)-Buji lokması (2)

3/8"

KISA

GS-320S

20 p.

ALTIKÖŞE: 1/4"-7/8"

\$104,10

Kısa Lokma: 1/4-5/16-3/8-7/16-1/2-9/16

19/32-5/8-11/16-3/4-25/32-13/16-7/8

Circir kol (1)-Uzatma (2)-T kolu (1)-Mafsal kol (1)-Buji lokması (2)

ALTIKÖŞE KROMAJLI LOKMA TAKIMI



3/8"

UZUN

GS-313M

13 p.

ALTIKÖŞE: 8-19mm

\$70,20

Uzun Lokma: m8-10-11-12-13-14-17-19

Circir kol (1)-Uzatma (2)-Buji lokması (2)

3/8"

UZUN

GS-313S

13 p.

ALTIKÖŞE: 5/16"-3/4"

\$88,10

Uzun Lokma: 5/16-3/8-7/16-1/2-9/16-5/8

11/16-3/4 Circir kol (1)-Uzatma (2)-Buji lok.(2)

ALTIKÖŞE KROMAJLI LOKMA TAKIMI



3/8"

KISA

GS-318M2

18 p.

ALTIKÖŞE: 6-22mm

\$77,40

Kısa Lokma: m6-7-8-10-11-12-13-14-15-16-17-19-22

Circir kol (1)-Uzatma (2)-Buji lokması (1)-T kolu (1)

3/8"

KISA

GS-319M1

18 p.

ALTIKÖŞE: 6-21mm

\$77,40

Kısa Lokma: m6-7-8-10-11-12-13-14-15-16-17-19-21

Circir kol (1)-Uzatma (2)-Buji lokması (1)-T kolu (1)

ALTIKÖŞE KROMAJLI LOKMA TAKIMI



3/8"

KISA-UZUN

GS-347MS

47 p.

ALTIKÖŞE: 6-19mm
ALTIKÖŞE: 1/4"-7/8"

\$126,80

Kısa Lokma: m6-7-8-9-10-11-12-13-14-15-16-17-18-19

1/4-5/16-3/8-7/16-1/2-9/16-5/8-11/16-3/4-13/16-7/8

Uzun Lokma: m10-11-12-13-14-15-16-17-18-19

3/8-7/16-1/2-9/16-5/8-11/16-3/4-13/16-7/8

Uzatma (2)-Circir kol (1)

ALTIKÖŞE KROMAJLI LOKMA TAKIMI



3/8"	KISA	EU-319M
19 p.	ALTIKÖŞE: 8-22mm	\$98,20

Kısa Lokma: m8-9-10-11-12-13-14-15-16-17-19-21-22
Circir kol (1)-Uzatma (3)-Ara mafsal (1)

ALTIKÖŞE KROMAJLI LOKMA TAKIMI



3/8"	KISA-UZUN	GS-331M
31 p.	ALTIKÖŞE: 8-19mm	\$131,50

Kısa Lokma: m8-9-10-11-12-13-14-15-16-17-18-19
Uzun Lokma: m8-9-10-11-12-13-14-15-16-17-18-19
Uzatma (3)-Circir kol (1)-Mafsal kol (1)-Ara mafsal (1)

YILDIZ KROMAJLI LOKMA TAKIMI



1/2"	KISA	EU-421S
21 p.	YILDIZ: 3/8"-1.1/4"	\$175,00

Kısa Lokma: 3/8-7/16-1/2-9/16-19/32-5/8-11/16-3/4-13/16
7/8-15/16-1.1/16-1.1/8-1.3/16-1.1/4
Circir kol (1)-Uzatma (2)-T kolu (1)-Ara mafsal (1)

YILDIZ KROMAJLI LOKMA TAKIMI



1/2"	KISA	TW-424M
24 p.	YILDIZ: 8-32mm	\$117,20

Kısa Lokma: m8-9-10-11-12-13-14-15-16-17-18-19-21-22-24-27
30-32
Circir kol (1)-Uzatma (2)-T kolu (1)-Ara mafsal (1)-Buji lokması (1)

ALTIKÖŞE KROMAJLI LOKMA TAKIMI



1/2"	KISA	TW-424S
24 p.	YILDIZ: 5/16"-1.1/4"	\$117,20

Kısa Lokma: 5/16-3/8-7/16-1/2-9/16-19/32-5/8-11/16-3/4
25/32-13/16-7/8-15/16-1.1/16-1.1/8-1.3/16-1.1/4
Circir kol (1)-Uzatma (2)-T kolu (1)-Ara mafsal (1)-Buji lokması (1)

1/2"	KISA	GS-417M
17 p.	ALTIKÖŞE: 10-32mm	\$97,60

Kısa Lokma: m10-11-12-13-14-15-17-19-22-24-27-30-32
Circir kol (1)-Uzatma (1)-T kolu (1)-Ara mafsal (1)

1/2"	KISA	GS-417S
17 p.	ALTIKÖŞE: 3/8"-1.1/4"	\$124,20

Kısa Lokma: 3/8-7/16-1/2-9/16-5/8-11/16-3/4-13/16-7/8-15/16
1-1/8-1/4-13/16-7/8
Circir kol (1)-Uzatma (1)-T kolu (1)-Ara mafsal (1)

ALTIKÖŞE KROMAJLI LOKMA TAKIMI



1/2"	KISA	GS-422M
22 p.	ALTIKÖŞE: 9-32mm	\$117,40

Kısa Lokma: m9-10-12-13-14-15-16-17-18-19-21-23-25-26-29-32
Circir kol (1)-Uzatma (2)-T kolu (1)-Ara mafsall (1)-Buji lokması (1)

1/2"	KISA	GS-422M2
22 p.	ALTIKÖŞE: 10-32mm	\$117,40

Kısa Lokma: m10-11-12-13-14-15-16-17-19-20-21-22-24-27-30-32
Circir kol (1)-Uzatma (2)-T kolu (1)-Ara mafsall (1)-Buji lokması (1)

1/2"	KISA	GS-422M3
22 p.	ALTIKÖŞE: 8-32mm	\$117,40

Kısa Lokma: m8-10-11-12-13-14-15-16-17-18-19-22-24-27-30-32
Circir kol (1)-Uzatma (2)-T kolu (1)-Ara mafsall (1)-Buji lokması (1)

1/2"	KISA	GS-422M4
22 p.	ALTIKÖŞE: 8-32mm	\$117,40

Kısa Lokma: m8-10-11-12-13-14-15-16-17-19-21-22-24-27-30-32
Circir kol (1)-Uzatma (2)-T kolu (1)-Ara mafsall (1)-Buji lokması (1)

1/2"	KISA	GS-422S
22 p.	ALTIKÖŞE: 3/8"-1.1/4"	\$129,30

Kısa Lokma: 3/8-7/16-1/2-9/16-19/32-5/8-21/32-11/16-3/4-25/32
13/16-7/8-15/16-1-1.1/8-1.1/4

Circir kol (1)-Uzatma (2)-T kolu (1)-Ara mafsall (1)-Buji lokması (1)

ALTIKÖŞE KROMAJLI LOKMA TAKIMI



ALTIKÖŞE KROMAJLI LOKMA TAKIMI



1/2"	KISA	GS-427M
27 p.	ALTIKÖŞE: 10-32mm	\$159,80

Kısa Lokma: m10-11-12-13-14-15-16-17-18-19-21-22-23-24-27
28-30-32

Circir kol (1)-Uzatma (2)-T kolu (1)-Ara mafsall (1)-Mafsall kol (1)
Buji lokması (1)-Mafsall kol sapı (1)

1/2"	KISA	GS-427S
27 p.	ALTIKÖŞE: 5/16"-1.1/4"	\$159,80

Kısa Lokma: 5/16-3/8-7/16-1/2-9/16-19/32-5/8-21/32-11/16
3/4-25/32-13/16-7/8-15/16-1-1.1/8-1.3/16-1.1/4

Circir kol (1)-Uzatma (2)-T kolu (1)-Ara mafsall (1)-Mafsall kol (1)
Buji lokması (1)-Mafsall kol sapı (1)

ALTIKÖŞE KROMAJLI LOKMA TAKIMI



1/2"	KISA	GS-424M3
24 p.	ALTIKÖŞE: 10-32mm	\$134,60

Kısa Lokma: m10-11-12-13-14-15-16-17-18-19-21-22-23-24-27-30-32
Circir kol (1)-Uzatma (2)-T kolu (1)-Ara mafsall (1)-Mafsall kol (1)

Buji lokması (1)

1/2"	KISA	EU-426M
26 p.	ALTIKÖŞE: 10-34mm	\$175,00

Kısa Lokma: m10-11-12-13-14-15-16-17-18-19-20-21-22-23-24
26-27-28-30-32-34

Circir kol (1)-Uzatma (2)-T kolu (1)-Ara mafsall (1)

ALTIKÖŞE KROMAJLI LOKMA TAKIMI



1/2" KISA GS-424M4
24 p. ALTIKÖŞE: 8-32mm \$139,60

Kısa Lokma: m8-10-11-12-13-14-15-16-17-18-19-21-22-24-27-30-32
Circir kol (1)-Uzatma (2)-T kolu (1)-Ara mafsall (1)-Firdöndü (1)

ALTIKÖŞE KROMAJLI LOKMA TAKIMI



1/2" KISA GS-424S
24 p. ALTIKÖŞE: 5/16"-1.1/4" \$129,30

Kısa lokma: 5/16-3/8-7/16-1/2-9/16-19/32-5/8-11/16-3/4
25/32-13/16-7/8-15/16-1.1/16-1.1/8-1.3/16-1.1/4
Circir kol (1)-Uzatma (2)-T kolu (1)-Ara mafsall (1)-Buji lokması (1)

ALTIKÖŞE KROMAJLI LOKMA TAKIMI



1/2" KISA GS-425S
24 p. ALTIKÖŞE: 5/16"-1.1/4" \$129,30

Kısa lokma: 5/16-3/8-7/16-1/2-9/16-19/32-5/8-11/16-3/4
25/32-13/16-7/8-15/16-1.1/16-1.1/8-1.3/16-1.1/4
Circir kol (1)-Uzatma (2)-Buji lokması (1)-Ara mafsall (1)
Mafsall kol (1)

ALTIKÖŞE KROMAJLI LOKMA TAKIMI



1/2" KISA GS-446MS
46 p. ALTIKÖŞE: 8-32mm
ALTIKÖŞE: 3/8"-1.1/4" \$233,80

Kısa lokma: m8-9-10-11-12-13-14-15-16-17-18-19-20-21-22-23
24-25-26-27-28-30-32
3/8-7/16-1/2-9/16-5/8-11/16-3/4-13/16-7/8-15/16-1.1/8
1.3/16-1.1/4
Circir kol (1)-Uzatma (2)-Buji lokması (2)-Ara mafsall (1)
Mafsall kol (1)-Mafsall kol sapı (1)-T kolu (1)

YILDIZ KROMAJLI LOKMA TAKIMI



1/2" KISA TW-422M1
22 p. YILDIZ: 8-32mm \$117,20

Kısa Lokma: m8-10-11-12-13-14-15-16-17-19-21-22-24-27-30-32
Circir kol (1)-Uzatma (2)-T kolu (1)-Ara mafsall (1)-Buji lokması (1)

ALTIKÖŞE KROMAJLI LOKMA TAKIMI



3/4"	KISA	EU-615M
15 p.	ALTIKÖŞE: 22-50mm	\$345,60

Kısa lokma: m22-24-27-30-32-33-34-36-41-46-50
Cırcır kol (1)T kolu (1)-Uzatma (2)

ALTIKÖŞE KROMAJLI LOKMA TAKIMI



3/4"	KISA	GS-615M
15 p.	ALTIKÖŞE: 27-63mm	\$326,90

Kısa lokma: m27-30-32-33-35-36-38-41-46-50-55-60-63
T kolu (1)-Uzatma (1)

3/4"	KISA	GS-615S
15 p.	ALTIKÖŞE: 1"-2.1/2"	\$326,90

Kısa Lokma: 1-1,1/8-1,1/4-1,3/8-1,1/2-1,5/8-1,3/4-1,7/8-2-2,1/8
2,1/4-2,3/8-2,1/2
T kolu (1)-Uzatma (1)

ALTIKÖŞE KROMAJLI LOKMA TAKIMI



3/4"	KISA	GS-617M
17 p.	ALTIKÖŞE: 21-50mm	\$386,90

Kısa lokma: m21-22-23-24-27-30-32-35-36-38-41-46-50
Cırcır kol (1)T kolu (1)-Uzatma (2)

3/4"	KISA	GS-617AS
17 p.	ALTIKÖŞE: 7/8"-2"	\$393,60

Kısa Lokma: 7/8-15/16-1-1,1/16-1,1/8-1,1/4-1,3/8-1,7/16-1,1/2
1,5/8-1,3/4-1,7/8-2
Cırcır kol (1)T kolu (1)-Uzatma (2)

ALTIKÖŞE KROMAJLI LOKMA TAKIMI



3/4"	KISA	GS-627M
27 p.	ALTIKÖŞE: 17-60mm	\$416,30

Kısa lokma: m17-19-20-21-22-23-24-27-30-31-32-33-34-35-36-37-38
40-41-45-46-48-50-54-55-57-60

3/4"	KISA	GS-627S
27 p.	ALTIKÖŞE: 3/4"-2.3/8"	\$464,30

Kısa lokma: 3/4-25/32-13/16-7/8-15/16-1"-1,1/16-1,1/8-1,3/16-1,1/4
1,5/16-1,3/8-1,7/16-1,1/2-1,9/16-1,5/8-1,11/16-1,3/4-1,13/16-1,7/8
1,15/16-2"-2,1/16-2,1/8-2,3/16-2,1/4-2,3/8

YILDIZ KROMAJLI LOKMA TAKIMI



3/4"	KISA	TW-617M
17 p.	YILDIZ: 21-50mm	\$393,60

Kısa lokma: m21-22-23-24-27-30-32-35-36-38-41-46-50
Circir kol (1) T kolu (1)-Uzatma (2)

3/4"	KISA	TW-617S
17 p.	YILDIZ: 7/8"-2"	\$527,00

Kısa Lokma: 7/8-15/16-1-1,1/16-1,1/8-1,1/4-1,3/8-1,7/16-1,1/2
1,5/8-1,3/4-1,7/8-2
Circir kol (1) T kolu (1)-Uzatma (2)

3/4"	KISA	TW-615S6
15 p.	YILDIZ: 15/16"-1.7/8"	\$327,00

Kısa Lokma: 5/16-1-1,1/8-1,1/4-1,5/16-1,3/8-1,7/16-1,1/2
1,5/8-1,3/4-1,7/8
Circir kol (1) T kolu (1)-Uzatma (2)

ALTIKÖŞE-YILDIZ KROMAJLI LOKMA TAKIMI



3/4"	KISA	TW-628MS
28 p.	YILDIZ: 22-50mm ALTIKÖŞE: 7/8"-2"	\$509,60

Kısa yıldız lokma: m22-24-27-30-32-36-38-41-46-50
Kısa altıköşe lokma: 7/8-15/16-1-1,1/8-1,3/16-1,5/16-1,3/8
1,7/16-1,5/8-1,3/4-1,7/8-2
Circir kol (1)-T kolu (1)-Uzatma (2)-Mafsals kol (1)

ALTIKÖŞE KROMAJLI LOKMA TAKIMI



1"	KISA	GS-816M
16 p.	ALTIKÖŞE: 36-80mm	\$920,50

Kısa lokma: m36-38-41-43-46-50-55-60-65-70-75-80
Circir kol (1)-T kolu (1)-Uzatma (2)

1"	KISA	GS-816M1
16 p.	ALTIKÖŞE: 36-80mm	\$920,50

Kısa lokma: m36-38-41-43-46-50-55-60-65-70-75-80
Circir kol (1)-T kolu (1)-Uzatma (2)

1"	KISA	GS-816M3
13 p.	ALTIKÖŞE: 41-80mm	\$867,10

Kısa lokma: m41-46-50-55-60-65-70-75-80
Circir kol (1)-T kolu (1)-Uzatma (2)

1"	KISA	GS-815S
15 p.	ALTIKÖŞE: 1.1/8"-2.1/2"	\$920,50

Kısa lokma: 1,1/8-1,1/4-1,3/8-1,1/2-1,5/8-1,3/4-1,7/8-2-2,1/8-2,1/4
2,3/8-2,1/2
Circir kol (1)-Uzatma (2)

1"	KISA	GS-816S6
16 p.	ALTIKÖŞE: 1.7/16"-3.1/8"	\$1.053,90

Kısa lokma: 1,7/16-1,1/2-1,11/16-1,7/8-2-2,1/4-2,3/8-2,1/2
2,5/8-2,3/4-2,15/16-3,1/8
Circir kol (1)-T kolu (1)-Uzatma (2)

ALTIKÖŞE KROMAJLI LOKMA TAKIMI



1"	KISA	GS-817M
17 p.	ALTIKÖŞE: 24-75mm	\$501,60

Kısa lokma: m24-27-30-32-33-35-36-38-41-46-50-54-55-60-65-70-75

1"	KISA	GS-817S
17 p.	ALTIKÖŞE: 1.7/16"-3.1/8"	\$780,50

Kısa lokma: 1,7/16-1,1/2-1,5/8-1,11/16-1,3/4-1,13/16-1,7/8-2,1/8-2,3/16-2,1/4-2,3/8-2,1/2-2,5/8-2,3/4-2,15/16-3,1/8

YILDIZ KROMAJLI LOKMA TAKIMI



1"	KISA	TW-816M1
16 p.	YILDIZ: 36-80mm	\$1.053,90

Kısa lokma: m36-38-41-43-46-50-55-60-65-70-75-80
Circir kol (1)-T kolu (1)-Uzatma (2)

1"	KISA	TW-815S
15 p.	YILDIZ: 1.1/2"-2.1/2"	\$1.196,70

Kısa lokma: 1,1/8-1,1/4-1,3/8-1,1/2-1,5/8-1,3/4-1,7/8-2-2,1/8-2,1/4-2,3/8-2,1/2
Circir kol (1)-Uzatma (2)

KROMAJLI TORX LOKMA TAKIMI



1/4"	KISA	TX-23414
3/8"	TORX: E.4-E.24	\$53,40
1/2"		
14 p.		

1/4" Kısa torx lokma: E.4-5-6-7-8

3/8" Kısa torx lokma: E.10-11-12-14-16

1/2" Kısa torx lokma: E.18-20-22-24

KROMAJLI TORX LOKMA TAKIMI



1/2"	KISA	TX-409
9 p.	TORX: E.10-E.24	\$54,60

Kısa torx lokma: E.10-11-12-14-16-18-20-22-24

KROMAJLI TORX LOKMA TAKIMI



1/4"	KISA	TX-2319
3/8"	TORX: E.4-E.20	\$80,10
19 p.		

1/4" Kısa torx lokma: E.4-5-6-7-8-10-11

3/8" Kısa torx lokma: E.10-11-12-14-16-18-20

Circir kol (1)-Uzatma (2)-Adaptör (1)-Mafsallı lokma sapı (1)

HAVALI ALTIKÖŞE LOKMALI ALLEN TAKIMI



3/8"	KISA	TH-310M
10 p.	ALTIKÖŞE: 4-17mm	\$73,00

Lokmalı Allen: m4-5-6-7-8-10-12-14-16-17

3/8"	KISA	TH-310S
10 p.	ALTIKÖŞE: 5/32"-5/8"	\$83,00

Lok. Allen: 5/32-3/16-7/32-1/4-5/16-3/8-7/16-1/2-9/16-5/8

HAVALI ALTIKÖŞE LOKMALI ALLEN TAKIMI



3/8"	KISA	TH-312M
12 p.	ALTIKÖŞE: 4-17mm	\$106,80

Lokmalı Allen: m4-5-6-7-8-10-12-14-16-17

Circir kol (1)-T kolu (1)

3/8"	KISA	TH-312S
12 p.	ALTIKÖŞE: 5/32"-5/8"	\$116,80

Lok. Allen: 5/32-3/16-7/32-1/4-5/16-3/8-7/16-1/2-9/16-5/8

Circir kol (1)-T kolu (1)

HAVALI ALTIKÖŞE LOKMALI ALLEN TAKIMI



1/2"	KISA	TH-408MD
8 p.	ALTIKÖŞE: 5-19mm	\$73,60

Lokmalı Allen: m5-6-8-10-12-14-17-19

1/2"	KISA	TH-410S
10 p.	ALTIKÖŞE: 3/16"-3/4"	\$101,60

Lok. Allen: 3/16-7/32-1/4-5/16-3/8-7/16-1/2-9/16-5/8-3/4

HAVALI ALTIKÖŞE LOKMALI ALLEN TAKIMI



1/2"	KISA	TH-412H
12 p.	ALTIKÖŞE: 5-19mm	\$121,20

Lokmalı Allen: m4-5-6-8-10-12-14-17-19

Circir kol (1)-T kolu (1)-Uzatma (1)

1/2"	KISA	TH-412S
12 p.	ALTIKÖŞE: 5/32"-3/4"	\$132,40

Lokmalı Allen: 5/32-3/16-1/4-5/16-3/8-7/16-1/2-5/8-3/4

Circir kol (1)-T kolu (1)-Uzatma (1)

HAVALI ALTIKÖŞE LOKMALI ALLEN TAKIMI



1/2"	KISA	TH-408M
8 p.	ALTIKÖŞE: 5-19mm	\$73,60

Lokmalı Allen: m5-6-8-10-12-14-17-19

1/2"	KISA	TH-408S
8 p.	ALTIKÖŞE: 3/16"-3/4"	\$84,80

Lokmalı Allen: 3/16-1/4-5/16-3/8-7/16-9/16-11/16-3/4

HAVALI LOKMALI TORX ALLEN TAKIMI



1/2"	KISA	TX-415
15 p.	TORX: T.7-T.70	\$155,00

Lokmalı Torx Allen: T.10-15-20-25-27-30-40-45-50-55-60-70
Circir kol (1)-T kolu (1)-Uzatma (1)

BİTS UÇ TAKIMLARI



5/16"- Arkalı 33.p	SC-233	\$63,80
-----------------------	--------	---------

Allen uç: m3-4-5-6-7-8 (30mm)
1/8-5/32-3/16-7/32-1/4-9/32-5/16 (30mm)
Torx uç: T.10-15-20-25-27-30-40-45-50 (30mm)
Düz uç: 5,5-5,6-7 (72mm)
Yıldız uç: Ph1-2-3-4- (72mm)
3/8"Uzatma (1)-3/8"Circir (1)-Bits uç adp.(1)

KROMAJLI ALTIKÖŞE LOKMALI ALLEN TAKIMI



1/2"	KISA	BS-409H
9 p.	ALTIKÖŞE: 4-17mm	\$45,30

Altıköşe lokmalı allen: m4-5-6-7-8-10-12-14-17 (80mm)



10mm-Arkalı 40.p	TX-3440	\$51,20
---------------------	---------	---------

10mmAllen uç: m4-5-6-7-8-10-12 (30mm)
10mmAllen uç: m4-5-6-7-8-10-12 (75mm)
10mmTorx uç: T.20-25-30-40-45-50-55 (30mm)
10mmTorx uç: T.20-25-30-40-45-50-55 (75mm)
10mmYıldız uç: m5-6-8-10-12 (30mm)
10mmYıldız uç: m5-6-8-10-12 (75mm)
Bits uç adp. (2)

KROMAJLI LOKMALI TORX ALLEN TAKIMI



1/2"	KISA	BS-409T
9 p.	TORX: T.20-T.60	\$56,30

Torx lokmalı allen: T.20-25-27-30-40-45-50-55-60 (80mm)

TORX BİTS UÇ TAKIMI

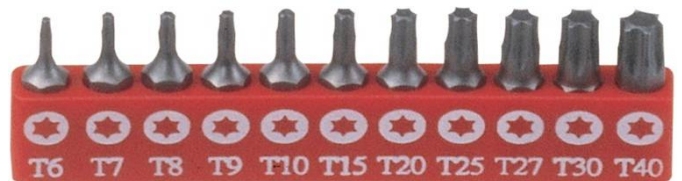

1/4"- Arkalı 11.p	SB-711TP	\$7,00
----------------------	----------	--------

Torx uç: T.6-7-8-9-10-15-20-25-27-30-40

KROMAJLI TORX-YILDIZ-ALTIKÖŞE LOKMALI ALLEN TAKIMI



3/8" 1/2" 16 p.	UZUN ALTIKÖŞE: 6-17mm TORX: T.55 YILDIZ: 8-12mm	TH-3416 \$91,70
-----------------------	--	--------------------

3/8" Altıköşe lokmalı allen: 6 (uzun)-6,7,8 (ex.uzun)
3/8" Yıldız lokmalı allen: 8 (uzun)-10,12 (ex.uzun)
1/2" Altıköşe lokmalı allen: 12,17 (kısa)-5,6,8,10 (uzun)
6,8 (ex.uzun)
1/2" Lokmalı torx allen: T.55 (uzun)

KARIŞIK TORX TAKIM



40.p	TX-23440	\$104,40
------	----------	----------

1/4" Dişi torx lokma: E.4-5-6-7-8
3/8" Dişi torx lokma: E.10-12-14-16-18-20
Torx allen: T.9-10-15-20-25-27-30-40-45-50-55-60-70
1/4" Allen uç: T.9-10-15-20 (30mm)
10mm Allen uç: T.25-27-30-40-45-50 (30mm)
14mm Allen uç: T.55 (115mm)-60-70 (75mm)
Bits uç adp. (3)

KARIŞIK TORX TAKIM



1/4" 3/8" 1/2" 41 p.	KISA TORX: T.7-T.70 E.4-E.20	BS-23441 \$184,50
-------------------------------	------------------------------------	----------------------

1/4" Torx lokma: E.4-5-6-7-8
3/8" Torx lokma: E.10-11-12-14-16
1/2" Torx lokma: E.18-20
1/4" Lokmalı torx allen: T.7-8-9-10-15-20-25-27-30
3/8" Lokmalı torx allen: T.40-45-50-55
1/2" Lokmalı torx allen: T.60-70
1/4" Lokmalı delikli torx allen: T.8-9-10-15-20-25-27-30
3/8" Lokmalı delikli torx allen: T.40-45-50-55
1/2" Lokmalı delikli torx allen: T.60-70

CIRCIRLI KOMBİNE ANAHTAR



Ölçü	Boy/mm	
8mm	135	\$9,30
9mm	142	\$9,40
10mm	158	\$10,20
11mm	167	\$10,20
12mm	173	\$11,10
13mm	179	\$11,40
14mm	189	\$12,00
15mm	199	\$12,30
16mm	215	\$13,50
17mm	232	\$13,50
18mm	238	\$14,00
19mm	247	\$15,00
20mm	285	\$22,70
21mm	285	\$23,30
22mm	285	\$23,30
24mm	325	\$28,80
27mm	355	\$36,50
28mm	355	\$44,70
30mm	425	\$44,70
32mm	425	\$44,70



Ölçü	Boy/mm	
17mm	128	\$13,50

KOMBİNE ANAHTAR



Ölçü	Boy/mm	
24mm	320	\$12,60
27mm	370	\$16,80
28mm	360	\$17,40
30mm	410	\$19,50
32mm	430	\$20,90
34mm	461	\$29,30
35mm	461	\$39,30
36mm	486	\$39,30
38mm	486	\$46,00
41mm	540	\$49,80
46mm	611	\$56,30
50mm	611	\$64,80
55mm	666	\$154,20
60mm	760	\$202,60
65mm	760	\$202,60

KOMBİNE ANAHTAR TAKIMI



7 -19mm 11.p	HS-011M	\$48,80
-----------------	---------	---------

m7-8-9-10-11-12-13-14-15-17-19

1/4"-7/8" 11.p	HS-011S	\$71,00
-------------------	---------	---------

1/4-5/16-3/8-7/16-1/2-9/16-5/8-11/16-3/4-13/16-7/8

KOMBİNE ANAHTAR TAKIMI



6-32mm 24.p	HS-024M	\$173,80
----------------	---------	----------

m6-7-8-9-10-11-12-13-14-15-16-17-18-19-20-21-22-23-24
25-26-27-30-32

6-32mm 26.p	PR-026M	\$251,90
----------------	---------	----------

m6-7-8-9-10-11-12-13-14-15-16-17-18-19-20-21-22-23-24
25-26-27-28-29-30-32

6-32mm 16.p	HS-016M	\$132,30
----------------	---------	----------

m6-7-8-9-10-11-12-13-14-17-19-22-24-27-30-32

6-22mm 17.p	PR-017M	\$100,20
----------------	---------	----------

m6-7-8-9-10-11-12-13-14-15-16-17-18-19-20-21-22

5/16"-1" 11.p	PR-011S	\$112,80
------------------	---------	----------

5/16-3/8-7/16-1/2-9/16-5/8-11/16-3/4-7/8-15/16-1"

1/4"-1,1/4" 16.p	HS-016S	\$125,10
---------------------	---------	----------

1/4-5/16-3/8-7/16-1/2-9/16-5/8-11/16-3/4-13/16-7/8
15/16-1-1,1/16-1,1/8-1,1/4

1/4"-1,1/4" 16.p	PR-016S	\$154,40
---------------------	---------	----------

1/4-5/16-3/8-7/16-1/2-9/16-5/8-11/16-3/4-13/16-7/8
15/16-1-1,1/16-1,1/8-1,1/4

CIRCIRLI KOMBİNE ANAHTAR TAKIMI



8-19mm 8.p	GW-7608M	\$95,00
---------------	----------	---------

m8-10-11-12-13-14-17-19

8-19mm 11.p	GW-7611M	\$137,90
----------------	----------	----------

m8-10-11-12-13-14-15-16-17-18-19

5/16"-3/4" 8.p	GW-7708S	\$111,40
-------------------	----------	----------

5/16-3/8-7/16-1/2-9/16-5/8-11/16-3/4

CIRCIRLI KOMBİNE ANAHTAR TAKIMI



8-19mm 7.p	WRGCM7	\$89,00
---------------	--------	---------

m8-10-12-13-14-17-19

CIRCIRLI KOMBİNE ANAHTAR TAKIMI



8-32mm
17.p

GW-7617M

\$350,00

m8-10-11-12-13-14-15-16-17-18-19-21-22-24-27-30-32

MAFSALLI CIRCIRLI KOMBİNE ANAHTAR TAKIMI



8-19mm
8.p

GFP-7608M

\$109,00

m8-10-12-13-14-15-17-19

YILDIZ ANAHTAR TAKIMI

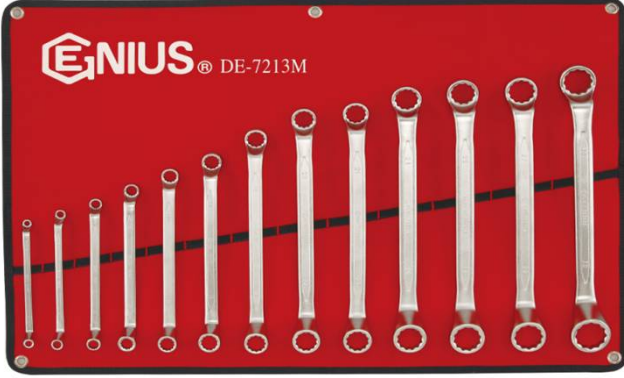

6-22mm MAT
8.p

DE-7208M

\$82,20

m6x7-8x9-10x11-12x13-14x15-16x17-18x19-20x22

6-32mm MAT
13.p

DE-7213M

\$189,60

m6x7-8x9-10x11-12x13-14x15-16x17-18x19-20x22
21x23-24x26-25x28-27x29-30x32

6-32mm
13.p

DE-713M

\$242,10

m6x7-8x9-10x11-12x13-14x15-16x17-18x19-20x22
21x23-24x26-25x28-27x29-30x32

1/4"-1.1/8"
8.p

DE-708S

\$145,70

1/4x5/16-3/8x7/16-1/2x9/16-5/8x11/16-3/4x13/16
7/8x15/16-1x1.1/16-1.1/8x1.1/4

İKİ AĞIZLI ANAHTAR TAKIMI



6-22mm
8.p

OW-708M

\$47,40

m6x7-8x9-10x11-12x13-14x15-16x17-18x19-20x22

6-32mm
13.p

OW-713M

\$97,50

m6x7-8x9-10x11-12x13-14x15-16x17-18x19-20x22
21x23-24x26-25x28-27x30-30x32

1/4"-1.1/4"
9.p

OW-709S

\$72,90

1/4x5/16-3/8x7/16-1/2x9/16-5/8x11/16-3/4x7/8
13/16x7/8-15/16x1-1x1.1/8-1.1/16x1.1/4

UZUN BOY ALLEN ANAHTAR



Ölçü

Boy

14mm

55x280mm

\$23,00

17mm

63x320mm

\$25,80

19mm

70x360mm

\$30,00

TORX ANAHTAR TAKIMI



E.6-E.24
4.p

TX-E04

\$40,40

6x8-10x12-14x18-20x24

UZUN ALLEN ANAHTAR TAKIMI



1,5-10mm 9.p	HK-009ML	\$27,20
m1,5-2-2,5-3-4-5-6-8-10		

BOMBE BAŞLI ALTIKÖŞE ALLEN ANAHTAR TAKIMI



1,5-10mm 9.p	HK-009MB	\$23,20
m1,5-2-2,5-3-4-5-6-8-10		

1/16"-3/8" 9.p	HK-009SB	\$23,20
1/16-5/64-3/32-1/8-5/32-3/16-1/4-5/16-3/8		



1,5-10mm 9.p / Kromajlı	HK-09MBS	\$25,60
m1,5-2-2,5-3-4-5-6-8-10		

1/16"-3/8" 9.p / Kromajlı	HK-09SBS	\$25,60
1/16-5/64-3/32-1/8-5/32-3/16-1/4-5/16-3/8		

TORX TORNAVİDA TAKIMI

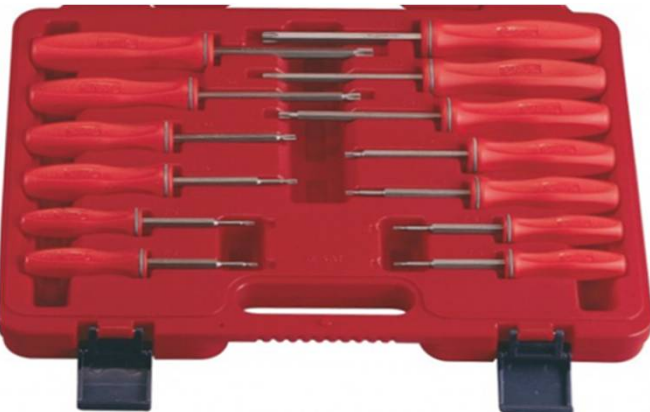

T.6-T.50 13.p	TX-513T	\$55,70
T.6-7-8-9-10-15-20-25-27-30-40-45-50		

TORX ALLEN ANAHTAR TAKIMI



T.9-T.50 10.p	SK-010S	\$20,90
T.9-10-15-20-25-27-30-40-45-50		

UZUN TORX ALLEN ANAHTAR TAKIMI



T.9-T.50 10.p	SK-010L	\$23,20
T.9-10-15-20-25-27-30-40-45-50		

UZUN DELİKLİ TORX ALLEN ANAHTAR TAKIMI



T.9-T.50 10.p	SK-010T	\$25,60
T.9-10-15-20-25-27-30-40-45-50		

LOKMA TORNAVİDA TAKIMI



6-14mm 9.p	NM-009MD	\$89,40
m6-7-8-9-10-11-12-13-14		

1/4"-1/2" 6.p	NM-006SD	\$89,40
1/4-5/16-11/32-3/8-7/16-1/2		

SAATÇI TORNAVIDA TAKIMI



6.P	TL-506	\$16,30
-----	--------	---------

Düz:0,4x2-0,4x2,5-0,5x3
Yıldız:Ph000-00-0

6.P	TL-506A	\$16,30
-----	---------	---------

Düz:0,3x1,2-0,3x1,6-0,4x2
Yıldız:Ph000-00-0

BİTS UÇ TAKIMI



1/4"- Arkalı 34.p	SC-234A	\$32,50
----------------------	---------	---------

Allen uç (6)-Düz uç (6)-Yıldız uç (3)-Torx uç (7)
Delikli torx uç (7)-Kare uç (3)-Uç sapı (1)-Adptör (1)

1/4"- Arkalı 37.p	SC-237M	\$32,50
----------------------	---------	---------

Allen uç (6)-Düz uç (6)-Yıldız uç (6)-Torx uç (7)
Delikli torx uç (7)-Yıldız allen uç (3)-Uç sapı (1)-Adptör (1)
Düz:0,3x1,2-0,3x1,6-0,4x2
Yıldız:Ph000-00-0

DARBELİ TORNAVIDA TAKIMI



1/2" - 6.P	TG-406B	\$33,70
------------	---------	---------

5/16"Düz uç (2)-5/16"Yıldız uç (2)-Adaptör (1)

KOMPLE DARBELİ TORNAVIDA TAKIMI



1/2" - 24.P	ID-424S	\$168,60
-------------	---------	----------

1/2"Havalı lokma: 5/16-3/8-7/16-1/2-9/16-5/8-11/16
3/4-13/16-7/8
1/2"Havalı lokmalı altıköşe allen: 3/16-7/32-1/4-5/16-3/8
1/2"Havalı lokmalı düz uç: 1,6x10-2x12-2,5x14-2,5x16
1/2"Havalı lokmalı yıldız uç: Ph1-2-3-4

DARBELİ TORNAVIDA



3/8"	700007	\$23,20
------	--------	---------

1/2"	700008	\$23,20
------	--------	---------

RULMAN ÇEKTİRME TABANI



30 - 50mm	XOR7202	\$37,60
-----------	---------	---------

50 - 75mm	XOR7203	\$58,50
-----------	---------	---------

75 - 105mm	XOR7204	\$91,90
------------	---------	---------

105 - 150mm	XOR7205	\$188,00
-------------	---------	----------

İKİ AYAKLI ÇEKTİRME

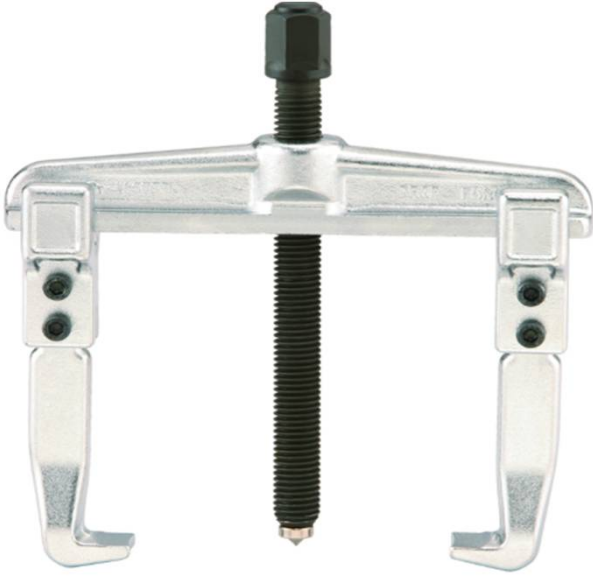

120 x 30-80mm	KA-2080	\$52,70
120 x 30-120mm	KA-2120	\$59,80
160 x 40-160mm	KA-2160	\$94,90
200 x 40-200mm	KA-2200	\$104,40

İKİ AYAKLI ÇEKTİRME



75 x 75mm	KJ-2076	\$21,60
100 x 100mm	KJ-2102	\$30,90
125 x 125mm	KJ-2127	\$45,30
150 x 150mm	KJ-2152	\$53,30
200 x 200mm	KJ-2203	\$96,60
250 x 250mm	KJ-2254	\$150,20
300 x 300mm	KJ-2305	\$201,80

ÜÇ AYAKLI ÇEKTİRME



75 x 75mm	KJ-3076	\$32,10
100 x 100mm	KJ-3102	\$42,30
125 x 125mm	KJ-3127	\$56,30
150 x 150mm	KJ-3152	\$68,60
200 x 200mm	KJ-3203	\$148,30
250 x 250mm	KJ-3254	\$229,00
300 x 300mm	KJ-3305	\$311,50

RULMAN ÇEKTİRME TAKIMI



30 - 70mm

AT-BS12
(XOR709)

\$162,90

Rulmak çekirme tabanı (2) + Çektirme gövdesi (1)
Çektirme ayağı 110mm (4) + 125mm (4)

75 - 150mm

XOR709L

\$431,60

Rulmak çekirme tabanı (2) + Çektirme gövdesi (1)
Çektirme ayağı 120mm (2) + 170mm (2) + 252mm (2)

HİDROLİK RULMAN ÇEKTİRME TAKIMI



75 - 105mm

XOR706E

\$367,50

Hidrolik mil (1) + Rulmak çekirme tabanı (1)
Çektirme gövdesi (1) + Çektirme ayağı 250mm (4)

HİDROLİK İKİ-ÜÇ AYAK VE RULMAN ÇEKTİRME TAKIMI



Rulman
75 - 105mm
2-3 Ayak
100-150-200mm

XOR706C

\$494,20

Hidrolik mil (1) + Rulmak çekirme tabanı (1)
Rulman çekirme gövdesi (1)
Rulman çekirme ayağı 200mm (2)
2 ayak çekirme gövdesi (1) + 3 ayak çekirme gövdesi (1)
2-3 ayak çekirme ayağı 100mm (3)
2-3 ayak çekirme ayağı 150mm (3)
2-3 ayak çekirme ayağı 200mm (3)

KAYNAKÇI TİPİ AYARLI PENSE



9" - 225mm

533309LW

\$29,30

UZUN AĞIZLI TİP AYARLI PENSE



6" - 150mm

531306LN

\$15,40

AYARLI PENSE



5" - 125mm	530305A	\$16,30
------------	---------	---------

7" - 175mm	530307A	\$20,90
------------	---------	---------

10" - 250mm	530310A	\$20,90
-------------	---------	---------

KESKİ ZIMBA TAKIMI



14.p	PC-514M	\$48,80
------	---------	---------

5 Keski-2 Nokta zimba-5 Pim zimba-2 Uzun pim zimba

TERS KILAVUZ TAKIMI



No:1-6
6.p

AT-EX6	\$10,50
--------	---------

3-25mm / 1/8"-1"

AYARLI FİLTRE PENSESİ



10"	53-118mm 2.1/8-4.5/8	AT-OF10A	\$26,50
-----	-------------------------	----------	---------

BUJİ LOKMALARI



16mm (5/8") 380mm	4238016T	\$15,10
----------------------	----------	---------

20,6mm (13/16") 380mm	4238021T	\$17,40
--------------------------	----------	---------



3/8"	16mm (5/8")	326016	\$8,20
------	----------------	--------	--------

3/8"	20,6mm (13/16")	326021	\$8,20
------	--------------------	--------	--------

1/2"	16mm (5/8")	427016	\$9,30
------	----------------	--------	--------

1/2"	20,6mm (13/16")	427021	\$9,30
------	--------------------	--------	--------

ÜÇ AYAK (AHTAPOT) FİLTRE ANAHTARI



3/8"	65-110mm 2.1/2-4.5/16	AT-B01	\$17,70
------	--------------------------	--------	---------

FİLLER ÇAKISI (ÇAKI SENTİL)

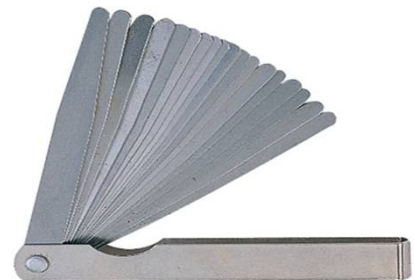

0,05-1,00mm 20 Yaprak	FG-020M	\$9,30
--------------------------	---------	--------

AMORTİSÖR YAY ÇEKTİRME



300mm
3/8" Soketli

AT-SC230

\$75,40

BALANS KURŞUNU ÇEKİCİ (PENSESİ)



250mm

560425

\$22,10

HORTUM KELEPÇE PENSESİ



220mm

AT-HC10

\$17,40

FREN DİSK AYAR TAKIMI



AT-08

\$145,00

SEGMAN ÇEMBERİ



90-175mm
100mm Boy

PR-1755

\$20,00

90-175mm
165mm Boy

PR-1757

\$26,00

ROTBAŞI TAMİR TAKIMI



AT-4808

\$75,40

SPIRALLİ MIKNATIS



AT-B24

\$15,10

Boy

600mm / 24"

Kapasite

1,60 Kg

TORKLU UZATMA TAKIMI



90-200nm
65-150ft.lb

TO-410EXT

\$226,20

TELESKOPİK MIKNATIS



AT-B16

\$11,60

Boy

645mm / 25,1/2"

Kapasite

1,60 Kg

MANYETİK STAND



305mm / 12"	005012	\$18,60
-------------	--------	---------

405mm / 16"	005016	\$22,00
-------------	--------	---------

İZOLELİ PENSE



7" - 175mm	551712S	\$22,60
------------	---------	---------

7" - 175mm	551712D	\$22,60
------------	---------	---------

İZOLELİ YANKESKİ



6" - 150mm	550607D	\$21,60
------------	---------	---------

İZOLELİ KARGABURUN



6" - 150mm	550604S	\$17,10
------------	---------	---------

6" - 150mm	550604D	\$17,10
------------	---------	---------

8" - 200mm	550804D	\$19,50
------------	---------	---------

İZOLELİ FORT PENSE



10" - 250mm	551011D	\$27,40
-------------	---------	---------

LOKMA ANAHTAR STANDI



1/4" - 410mm 15 Klips	010152	\$8,20
--------------------------	--------	--------

3/8" - 480mm 15 Klips	010153	\$8,20
--------------------------	--------	--------

1/2" - 560mm 15 Klips	010154	\$9,30
--------------------------	--------	--------

TOPUKLU KEÇE LEVYESİ



561116	\$14,00
--------	---------

Boy	405mm
-----	-------

SAPLAMA SÖKME TAKIMI



6-12mm 4.p	FD-404M	\$47,60
---------------	---------	---------

m6-8-10-12

MEKANİK (EL) GRES POMPASI

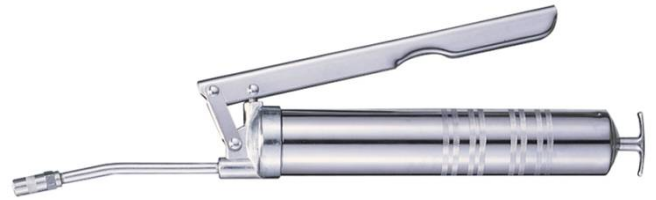

500cc	AT-46012	\$27,90
-------	----------	---------

SAC MAKASI



10" - 250mm Sağ	511002R	\$19,80
--------------------	---------	---------

DÜZ İÇ SEGMAN PENSESİ



7" - 175mm

550751

\$22,10

EĞRİ İÇ SEGMAN PENSESİ



7" - 175mm

550753

\$22,10

DÜZ DIŞ SEGMAN PENSESİ

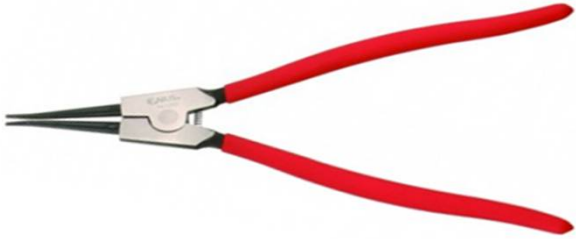

7" - 175mm

550750

\$22,10

EĞRİ DIŞ SEGMAN PENSESİ



7" - 175mm

550752

\$22,10

ELMAS EĞE TAKIMI



FL-0785

\$32,50

200mm 5 Parçalı

POP PERÇİN PENSESİ



SC-715

\$31,40

2,4 - 3,2 - 4 - 4,8mm

KOLLU POP PERÇİN PENSESİ



SC-714

\$51,10

3,2 - 4 - 4,8 - 6,4mm

SOMUNLU PERÇİN PENSESİ



SC-758A

\$66,20

3 - 4 - 5 - 6mm

KOLLU SOMUNLU PERÇİN PENSESİ



SC-785M

\$192,60

5 - 6 - 8 - 10mm

KURBAĞACIK



4" - 100mm	780128	\$15,10
6" - 150mm	780192	\$15,10
8" - 200mm	780256	\$16,80
10" - 250mm	780320	\$22,30
12" - 300mm	780384	\$29,30
15" - 380mm	780480	\$59,40
18" - 450mm	780576	\$105,40
24" - 600mm	780692	\$219,30

BORU ANAHTARI



12" - 300mm	782300	\$38,30
14" - 350mm	782350	\$46,20
18" - 460mm	782460	\$65,10
24" - 600mm	782610	\$99,20
36" - 900mm	782910	\$153,60
48" - 1200mm	783220	\$344,80

KOMPLE ÇANTALI EL ALETİ TAKIMI



125.p	AC-234125	\$306,30
1/4" Altıköşe kısa lokma:m4-4,5-5-5,5-6-7-8-9-10-11-12-13		
3/8" Altıköşe kısa lokma:m6-7-8-9-10-11-12-13-14-15-16-17-18-19		
1/2" Altıköşe kısa lokma: m11-12-13-14-15-16-17-18-19-20-21-22-23-24-25-26-27		
1/4" Bits uçlar:Düz (4)-Yıldız (8)-Allen (6)-Torx (7)-Robertson (3)		
Cırcır kol:3/8 (1)-1/2 (1) Uzatma:1/4 (1)-3/8 (2)-1/2 (2)		
1/4"Lokma sapı-1/4"Uç sapı-1/4"Manyetik adp. Buji lokması: 1/2 (2)		
1/4"Uç adp.-Pense-Yankeski-Kargaburun		
Allen anahtar: m1,5-2-2,5-3-4-5-6-8-10		
Kombine anahtar: m6-7-8-9-10-11-12-13-14-15-16-17-19		

KOMPLE ÇANTALI EL ALETİ TAKIMI



151.p	AC-234151	\$506,70
1/4" Altıköşe kısa lokma:m4-5-5,5-6-7-8-9-10-11-12		
1/8-3/16-7/32-1/4-9/32-5/16-11/32		
1/4"Kısa dişi torx lokma:E.4-5-6-7-8-10		
1/4"Kısa kare lokma: m8-10		
3/8" Altıköşe kısa lokma:m13-14-15-16-17-18-19		
3/8" Altıköşe uzun lokma:m8-9-10-12-13-14-15-16-17-18-19		
3/8"Yıldız kısa lokma:3/8-7/16-1/2-9/16-5/8-11/16-3/4-13/16-7/8		
3/8"Kısa dişi torx lokma: E.12-14-16-18-20		
1/2" Altıköşe kısa lokma: m20-21-22-24-27-30-32		
1/2"Yıldız kısa lokma: 15/16-1,1/16-1,1/4		
1/2" Altıköşe kısa havallı lokma:m17-18-19-21-22		
1/4"Bits uçlar:Düz (4)-Yıldız (8)-Allen (6)-Torx (7)-D.torx (11)		
Cırcır kol:1/4 (1)-3/8 (1)-1/2 (1) Ara mafsal:1/4 (1)-3/8 (1)-1/2 (1)		
Uzatma:1/4 (1)-3/8 (2)-1/2 (2) Buji lokması: 3/8 (2)		
1/4"Lokma sapı-1/4"Uç sapı-1/4"Manyetik adp.		
1/4"Uç adp.-Pense-Yankeski-Kargaburun		
Allen anahtar: m1,5-2-2,5-3-4-5-6-8-10		
Kombine anahtar: m8-9-10-11-12-13-14-15-16-17-18-19		

KOMPLE ÇANTALI EL ALETİ TAKIMI



161.p	AC-234161R	\$522,00
1/4" Altıköşe kısa lokma:m4-4,5-5-5,5-6-7-8-9-10-11-12		
1/8-3/16-7/32-1/4-9/32-5/16-11/32		
1/4" Kısa dişi torx lokma:E.4-5-6-7-8-10		
1/4" Altıköşe uzun lokma:m8-9-10-12-13-14		
3/8" Altıköşe kısa lokma:m13-14-15-16-17-18-19		
3/8" Yıldız kısa lokma:3/8-7/16-1/2-9/16-5/8-11/16-3/4-13/16-7/8		
3/8" Kısa dişi torx lokma: E.12-14-16-18-20		
1/2" Altıköşe kısa lokma: m20-21-22-24-27-30-32		
1/2" Yıldız kısa lokma: 15/16-1,1/16-1,1/4		
1/2" Altıköşe uzun havalı lokma:m17-19-21		
Cırcır kol:1/4 (1)-3/8 (1)-1/2 (1) Ara mafsalsal:1/4 (1)-3/8 (1)-1/2 (1)		
Uzatma:1/4 (2)-3/8 (1)-1/2 (2) Buji lokması: 3/8 (3)		
1/4" Lokma sapı-1/4" Torn. için lokma adp. (3)-Uç sapı-1/4" Manyetik adp.		
1/4" Lokma sapı-Pense-Yankeski-Kargaburun		
1/4" S.Sıkma için uç adp.-1/4" Torn. için lokma adp. (3)-1/4" Manyetik adp.		
1/4" Bits uçlar:Düz (6)-Yıldız (8)-Allen (8)-Torx (11)-D.torx (14)-Fare dş (3)		
Allen anahtar: m1,5-2-2,5-3-4-5-6-8-10		
Kombine anahtar: m8-9-10-11-12-13-14-15-16-17-18-19		

ÇEKMECELİ TAKIM DOLABI



TS-790	\$665,10
10 Çekmeceli - Boş	
660x455x483mm	

ÇEKMECELİ TAKIM ARABASI



TS-798	\$986,00
7 Çekmeceli - Boş	
670x460x813mm	

TS-798/198P	\$2.380,40
7 Çekmeceli - Dolu: 198 parça	
670x460x813mm	
MS-437M	37 P.Lokma seti
MS-007P	7 P.Pense seti
MS-008R	8 P.Filtre ve Segman pense seti
MS-019	19 P.Çekiç ve Keski seti
MS-020M	20 P.Kombine Anahtar seti
MS-020B	20 P.Açık ağız, Torx Yıldız an. seti
MS-086	86 P.Tornavida,Bitsuç ve Allen an.

ÇEKMECELİ TAKIM ARABASI VE DOLABI MUHTEVİYATLARI



20 P.Açıkbaşlı,Torx,Yıldız anahtar seti
Açıkbaşlı: 6x7-8x9-10x11-12x13-14x15
16x17-18x19-20x22
Yıldız: 6x7-8x9-10x11-12x13-14x15
16x17-18x19-20x22
Torx: 6x8-10x12-14x18-20x24

MS-020B

\$203,00



20 P.Kombine Anahtar seti
Kombine: m6-7-8-9-10-11-12-13-14-15
16-17-18-19-21-22-24-27-30-32

MS-020M

\$203,00



23 P.Lokma seti
1/2" Yıldız Lokma: 8-10-11-12-13-14-15
16-17-18-19-21-22-23-24-27-30-32
Uzatma (2)-Mafsal-T kol-Circir

TW-423M

\$141,60



37 P.Lokma seti
1/2" Altıköşe Lok: 8-9-10-11-12-13-14
15-16-17-18-19-21-22-24-27-30-32-36
1/2" Torx Lokma: 10-11-12-14-16-18-20
22-24
1/2" Buji Lokması: 16-20,6
Uzatma (3)-Mafsal-Adaptör
Mafsal kol-Circir

MS-437M

\$261,00



7 P.Pense seti
Pense 180mm-Yankeski 180mm
Düz kargaburun 200mm
Eğri kargaburun 200mm
Ayarlı pense 250mm-Fort pense 250mm
Uzun burunlu ayarlı pense 150mm

MS-007P

\$154,30



8 P.Filtre ve Segman pense seti

MS-008R

\$153,20



19 P.Çekiç ve Keski seti
Keski: 6x125-10x140-14x150-19x200
25x200
Nokta zımba: 3x60-5x70-6x75-8x80
9x85
Pim zımba: 2x100-3x125-4x140-5x60
6x200
8x200 - Çekiç (2)

MS-019

\$191,40

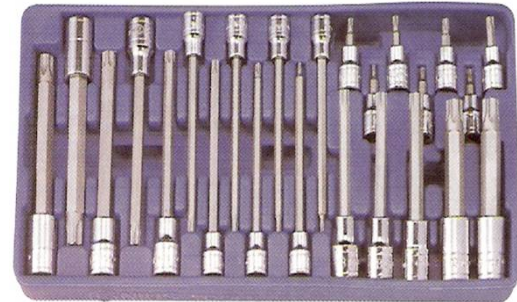

24 P.Lokmalı Torx allen seti
3/8"Lok.torx:T.10-15-20-25-27-30
40 (50mm)
3/8"Lok.torx:T.10-15-20-25-27-30
40 (140mm)
1/2"Lok.torx:T.45-50-55-60-70 (80mm)
1/2"Lok.torx:T.45-50-55-60-70 (150mm)

BS-3424T

\$127,60

ÇEKMECELİ TAKIM ARABASI VE DOLABI MUHTEVİYATLARI

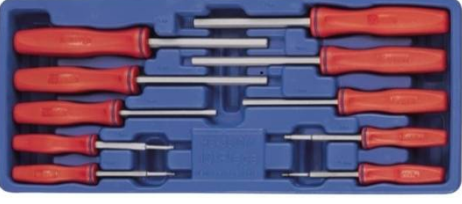

10 P.Allen tornavida seti
m2-2,5-3-4-5-6-7-8-9-10

HS-5610M
\$55,70

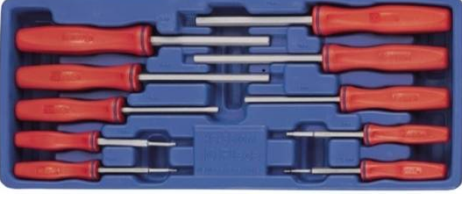

12 P.Allen tornavida seti
1/16-5/64-3/32-7/64-1/8-5/32-3/16
7/32-1/4-9/32-5/16-3/8

HS-5612S
\$55,70

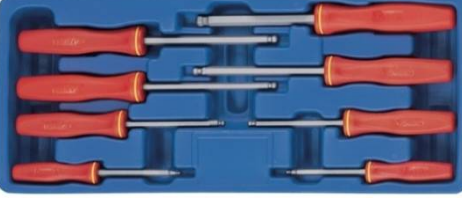

8 P.Bombe Başlı Allen tornavida seti
m3-4-5-6-7-8-9-10

HS-5708MW
\$52,20

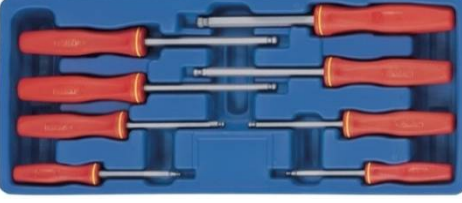

8 P.Bombe Başlı Allen tornavida seti
1/8-5/32-3/16-7/32-1/4-9/32
5/16-3/8

HS-5708SW
\$55,70

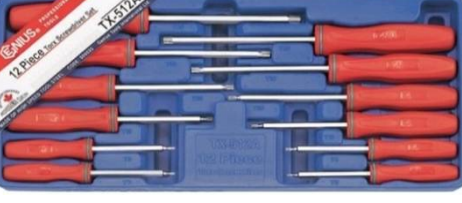

12 P.Delikli Torx tornavida seti
T.6-7-8-9-10-15-20-25-27-30-40-45

TX-512A
\$46,40

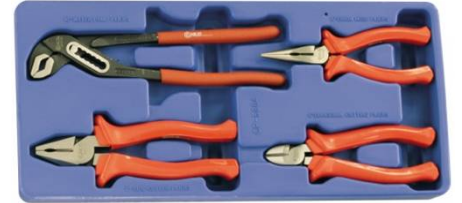

4 P.Pense seti
Pense 180mm-Kargaburun 150mm
Yankeski 150mm-Fort pense 250mm

CP-5804
\$89,40



7 P.Açıkbaş anahtar seti
6x7-8x9-10x11-12x13-14x15-16x17
18x19

OW-707M
\$38,30



24 P.Kombine,Yıldız anahtar seti
Kombine: m6-7-8-9-10-11-12-13-14-15
16-17-18-19-21-22
Yıldız: 6x7-8x9-10x11-12x13-14x15
16x17-18x19-20x22

MS-024M
\$232,00



24 P.Torx lokma ve bits uç seti
3/8" Torx lokma: E.10-11-12-14-16
18-20
1/4" Torx uç: T.8-10-15-20-25-27
30-40-45-50
İkibağz torx anahtar: 6x8-10x12
14x18-20x24
Bits uç adp. (3)

TX-2324
\$107,20



4 P.segman pense seti
Yaylı düz 180mm-Yaylı eğri 180mm
Yaysız düz 180mm-Yaysız eğri 180mm

RP-5504
\$89,40

ÇEKMECELİ TAKIM ARABASI VE DOLABI MUHTEVİYATLARI



35 Pense,Kurbağacık,Allen,Çekiç ve
Torn.seti-Düz torn.(5)-Yıldız torn.(5)
Pense 175mm-Yankeski 150mm
Düz k.burun150mm-Fort prnse 250mm
B.Baş allen an.takımı (2)
Kurbağacık 200mm-Ayarlı pense 175mm
Çekiç

MS-035MS

\$220,40



86 P.Tornavida,Bits uç ve Allen an.
Düz torn.(4)-Delikli torx torn.(10)
Yıldız torn.(Ph 2-Pz 2)-Flex bits tut.
Bits uç (44)-Manyetik bits tutucu
Bits uç sapı (3)-B.Baş allen an.takımı
Delikli torx allen an.takımı

MS-086

\$228,60

CIRCIRLI TORK ANAHTARI



Soket 1/4"
Kapasitesi 3-15nm
Boyu 350mm

290015N

\$90,50

Soket 1/4"
Kapasitesi 6-30nm
Boyu 350mm

280030N

\$90,50

Soket 3/8"
Kapasitesi 6-30nm
Boyu 350mm

380030N

\$90,50

Soket 3/8"
Kapasitesi 19-110nm
Boyu 385mm

380110N

\$98,60

Soket 1/2"
Kapasitesi 40-210nm
Boyu 535mm

480210N

\$110,20

Soket 1/2"
Kapasitesi 70-350nm
Boyu 645mm

480350N

\$146,20

Soket 3/4"
Kapasitesi 100-500nm
Boyu 865mm

680500N

\$228,60

Soket 3/4"
Kapasitesi 140-700nm
Boyu 1092mm

680700N

\$603,20

Soket 3/4"
Kapasitesi 140-980nm
Boyu 1230mm

680980N

\$751,70

Soket 3/4"
Kapasitesi 200-1000nm
Boyu 1335mm

691000N

\$827,00

Soket 1"
Kapasitesi 140-980nm
Boyu 1230mm

880980N

\$777,20

Soket 1"
Kapasitesi 300-1500nm
Boyu 1700mm

881500N

\$1.111,80

Soket 1"
Kapasitesi 400-2000nm
Boyu 2175mm

882000N

\$1.475,60

Soket 1"
Kapasitesi 400-2000nm
Boyu 2150mm

892000N

\$1.475,60

Soket 1.1/2"
Kapasitesi 600-3000nm
Boyu 2780mm

993000N

\$1.754,00

DEĞİŞTİRİLEBİLEN KAFALI TORK ANAHTAR TAKIMI



Kafa	9x12mm
Kapasitesi	19-110nm
3/8" Geçmeli Cırcır kafası (1)	
Geçmeli Açık ağız anahtar ağızı (11)	
m.10,11,12,13,14,15,16,17,18,19	

TO-312N11

\$191,40

Kafa	14x18mm
Kapasitesi	40-210nm
1/2" Geçmeli Cırcır kafası (1)	
Geçmeli Açık ağız anahtar ağızı (9)	
m.13,14,15,17,19,22,24,27,30	

TO-411N21

\$220,40

TORNAVİDA TİPİ TORK ANAHTARI



Soket	1/4"
Kapasitesi	9-50in.lbs
Boy	150mm

280045L

\$127,60

Soket	1/4"
Kapasitesi	1-5nm
Boy	150mm

280005N

\$127,60



Soket	1/4"
Kapasitesi	1-5nm
Boy	150mm

Tornavida tipi tork anahtarı: 280005N

30mmDüz torn. ucu: m1x6-1x6,5-1,2x7

30mmYıldız tornavida ucu: Ph1-2-3

30mmAllen tornavida ucu: m3-4-5-6

1/8-5/32-3/16-7/32-1/4

30mmDelikli torx uc: T.10-15-20-25-27

30-40

30mmYıldız (fare diş) torn. ucu: m4-5-6

Bits uç adaptörü:1/4-1/4

TO-227N

\$150,80

DEĞİŞTİRİLEBİLEN KAFALI DİJİTAL TORK ANAHTAR TAKIMI



Kafa	14x18mm
Kapasitesi	10-100nm
3/8"-1/2" Geçmeli Cırcır kafası (2)	

1434N10

\$406,00

Kafa	14x18mm
Kapasitesi	20-200nm
3/8"-1/2" Geçmeli Cırcır kafası (2)	

1434N20

\$452,40

TORK YÜKSELTİCİ

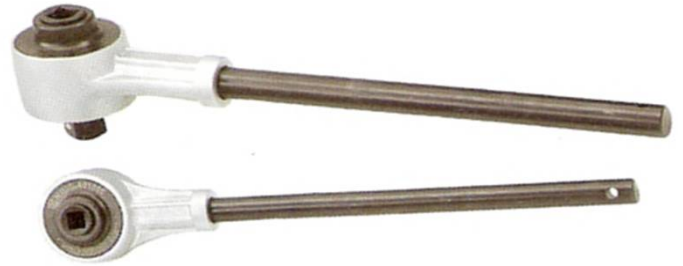

Giriş	3/4"-Max:900nm
Çıkış	1"-Max:2700nm
Tur sayısı	3/1
Boy/mm	500mm
Ağırlığı	4,75 Kg

602000

\$510,40



Giriş	1/2"-Max:400nm
Çıkış	1"-Max:4000nm
Tur sayısı	10/1
Boy/mm	260mm
Ağırlığı	18,50 Kg

494008B

\$1.038,20

"T" KOLLAR



1/4"	150mm	280020	\$4,50
3/8"	250mm	380030	\$7,40
1/2"	320mm	480040	\$11,90
3/4"	500mm	680060	\$26,70
1"	630mm	880063	\$93,40
1.1/2"	915mm	980090	\$169,50

"L" KOLLAR



1/2"	260mm	420260L	\$11,90
3/4"	330mm	620330L	\$20,10
3/4"	400mm	620400L	\$26,70

CIRCIR KOLLARI



1/4"	Çevirmeli	280272	\$14,50
1/4"	Mandallı	280222R	\$19,00
3/8"	Çevirmeli	383372	\$20,30
3/8"	Mandallı	380333R	\$24,80
3/8"	Mandallı-Mafsal.	383363	\$53,80
1/2"	Çevirmeli	480472	\$21,90
1/2"	Mandallı	480444R	\$26,10
1/2"	Mandallı-Göbek	480444H	\$28,00
3/4"	çıkmalı	680666R	\$72,50
1"	Mandallı	880888R	\$97,30

MAFSALLI KOLLAR



3/8"	200mm	380336A	\$15,10
1/2"	380mm	480446A	\$26,70
3/4"	560mm	680446E	\$95,20
1"	815mm	880846E	\$130,80

FIRDÖNDÜ KOLLAR



3/8"	400mm	380400	\$12,70
1/2"	420mm	480420	\$20,90

LOKMA SAPI



1/4"	140mm	220150	\$4,90
------	-------	--------	--------

HAVALI LOKMA ADAPTÖRLERİ



1/4-3/8	25mm	290030	\$3,50
3/8-1/4	30mm	380020	\$3,50
3/8-1/2	35mm	380040	\$4,30
1/2-3/8	38mm	480033MB	\$5,10
1/2-3/4	41mm	40066MB	\$9,50
3/4-1/2	63mm	640604B	\$17,50
3/4-1"	65mm	640608B	\$17,40
1"-3/4	70mm	841006B	\$21,90
1"-1.1/2	80mm	841012B	\$42,00
1.1/2-1"	98mm	938008	\$124,80
1.1/2-2.1/2	80mm	938020	\$525,50
2.1/2-1.1/2	98mm	920012	\$1.576,00

KROMAJLI LOKMA ADAPTÖRLERİ



1/4-3/8	25mm	280030	\$4,00
3/8-1/2	35mm	320040	\$5,50
1/2-3/8	38mm	420033	\$6,50
3/4-1/2	63mm	620604	\$15,40
3/4-1"	65mm	620608	\$18,40
1"-3/4	70mm	821006	\$18,40

ADAPTÖR YEDEK KARELERİ



1/2"	\$6,20
3/4"	\$13,40
1"	\$40,10

HAVALI MAFSALLAR (SARHOŞ)



1/4"	40mm	700106	\$14,00
3/8"	65mm	700107	\$14,00
1/2"	70mm	700108	\$15,80
3/4"	110mm	640606B	\$46,40
1"	130mm	840808B	\$105,00

KROMAJLI MAFSALLAR (SARHOŞ)



1/4"	40mm	280070	\$7,80
3/8"	54mm	380070	\$12,20
1/2"	78mm	480070	\$15,40
3/4"	110mm	680606	\$45,80
1"	130mm	880808	\$53,40

HAVALI LOKMA UZATMALARI



3/8"	75mm	340075B	\$5,80
3/8"	125mm	340125B	\$7,60
3/8"	150mm	380036	\$8,20
3/8"	200mm	340200B	\$13,40
1/2"	50mm	480030MB	\$14,00
1/2"	75mm	480032MB	\$6,80
1/2"	125mm	480036MB	\$7,50
1/2"	150mm	480150MB	\$8,30
1/2"	200mm	410008	\$9,90
1/2"	250mm	480250MB	\$26,70
3/4"	100mm	640100B	\$21,20
3/4"	150mm	640150B	\$25,40
3/4"	200mm	640200B	\$29,50
3/4"	250mm	640250B	\$34,20
1"	150mm	840150B	\$39,00
1"	200mm	841064B	\$52,30
1"	250mm	840250B	\$62,50
1"	400mm	840400B	\$124,80
1.1/2"	175mm	938175	\$727,10
1.1/2"	250mm	938250	\$862,70

KROMAJLI LOKMA UZATMALARI



1/4"	100mm	220004	\$6,80
1/4"	150mm	220006	\$6,80
3/8"	75mm	320075	\$7,70
3/8"	150mm	320150	\$7,70
3/8"	200mm	320200	\$8,20
3/8"	250mm	320250	\$9,00
1/2"	75mm	424075	\$7,70
1/2"	125mm	424125	\$7,70
1/2"	250mm	424320	\$10,10
1/2"	200mm	424200	\$10,10
1/2"	300mm		\$10,10
3/4"	100mm	620100	\$16,80
3/4"	150mm	620150	\$16,80
3/4"	200mm	620200	\$16,80
3/4"	250mm	620250	\$16,80
3/4"	400mm	620400	\$30,10
1"	150mm	820150	\$31,00
1"	200mm	820200	\$31,00
1"	250mm	820250	\$31,00
1"	400mm	820400	\$75,20

BOMBE BAŞLI KROMAJLI LOKMA UZATMALARI



1/2"	75mm	420003B	\$8,70
1/2"	125mm	420005B	\$11,90
1/2"	200mm	420008B	\$14,60
1/2"	250mm	420010B	\$16,30

HAVALI LOKMALI DÜZ TORNAVİDA UÇLARI



3/8"			
1x5,5	52mm	3452P055	\$7,10
1,2x8	52mm	3452P08	\$7,10
1,6x10	52mm	3452P10	\$7,10

1/2"			
1,6x10	60mm	4460P10	\$7,10
2x12	60mm	4460P12	\$7,10
2,5x14	60mm	4460P14	\$7,10
2,5x16	60mm	4460P16	\$7,10

HAVALI LOKMALI YILDIZ TORNAVIDA UÇLARI



3/8"

Ph1	52mm	3452R01	\$7,10
Ph2	52mm	3452R02	\$7,10
Ph3	52mm	3452R03	\$7,10
Ph4	52mm	3452R04	\$7,10

1/2"

Ph1	60mm	4460R01	\$7,10
Ph2	60mm	4460R02	\$7,10
Ph3	60mm	4460R03	\$7,10
Ph4	60mm	4460R04	\$7,10

HAVALI LOKMALI ALTİKÖŞE ALLENLER



3/8"

4mm	52mm	345204	\$6,30
5mm	52mm	345205	\$6,30
6mm	52mm	345206	\$6,30
7mm	52mm	345207	\$6,30
8mm	52mm	345208	\$6,30
10mm	52mm	345210	\$6,30
12mm	52mm	345212	\$6,30
5/32	52mm	365205	\$7,30
3/16	52mm	365206	\$7,30
7/32	52mm	365207	\$7,30
1/4	52mm	365208	\$7,30
5/16	52mm	265210	\$7,30
3/8	52mm	365212	\$7,30
7/16	52mm	365214	\$9,00
1/2	52mm	365216	\$9,00
9/16	52mm	365218	\$9,30
5/8	52mm	365220	\$9,50

1/2"

4mm	60mm	446004	\$7,00
5mm	60mm	446005	\$7,00
6mm	60mm	446006	\$7,00
7mm	60mm	446007	\$7,80
8mm	60mm	446008	\$7,80
9mm	60mm	446009	\$7,80
10mm	60mm	446010	\$7,80
12mm	60mm	446012	\$7,80
14mm	60mm	446014	\$8,00
14mm	76mm	446014	\$11,50
16mm	60mm	446016	\$8,50
17mm	60mm	446017	\$8,50
19mm	60mm	446019	\$9,70
5/32	60mm	466005	\$7,90
3/16	60mm	466006	\$7,90
7/32	60mm	466007	\$8,40
1/4	60mm	466008	\$8,40
5/16	60mm	466010	\$8,40
3/8	60mm	466012	\$8,40
7/16	60mm	466014	\$8,40
1/2	60mm	466016	\$8,40
9/16	60mm	466018	\$9,30
5/8	60mm	466020	\$12,00
11/16	60mm	466022	\$12,00
3/4	60mm	466024	\$12,00

3/4"

14mm	80mm	619+2914	\$26,30
17mm	80mm	619+2917	\$26,30
19mm	88mm	619+2919	\$26,30
21mm	88mm	648821	\$26,30
22mm	88mm	622+2922	\$26,30
24mm	88mm	622+2924	\$28,00
27mm	88mm	627+2927	\$28,00
30mm	88mm	627+2930	\$28,00
32mm	88mm	627+2932	\$30,70

1"

17mm	85mm	819+2917	\$30,70
19mm	98mm	819+2919	\$30,70
21mm	98mm	849821	\$30,70
22mm	98mm	822+2922	\$30,70
24mm	98mm	822+2924	\$32,40
27mm	98mm	827+2927	\$32,40
30mm	98mm	827+2930	\$35,00
32mm	98mm	827+2932	\$35,00
33mm	98mm	832+2933	\$36,80
36mm	98mm	832+2936	\$36,80

HAVALI LOKMALI TORX ALLENLER



1/2"

T.30	60mm	4460S30	\$8,20
T.40	60mm	4460S40	\$8,20
T.70	60mm	4460S70	\$9,70

KROMAJLI UZUN BOMBE BAŞLI

LOKMALI ALTİKÖŞE ALLENLER



1/2"

6mm	230mm	408+4836	\$10,30
8mm	230mm	410+4848	\$10,30

KROMAJLI KISA LOKMALI ALTİKÖŞE ALLENLER



1/4"			
2mm	26mm	232802	\$4,30
2,5mm	26mm	208+2125	\$4,30
3mm	26mm	232803	\$4,30
4mm	26mm	232804	\$4,30
5mm	26mm	232805	\$4,30
6mm	26mm	232806	\$4,30
7mm	26mm	232807	\$4,30
8mm	26mm	232808	\$4,30
9mm	26mm	232809	\$4,30
10mm	26mm	232810	\$4,30
1/16	45mm	208+3104	\$6,40
5/64	45mm	208+3105	\$6,40
3/32	45mm	208+3106	\$6,40
7/64	45mm	208+3107	\$6,40
1/8	45mm	208+3108	\$6,40
5/32	45mm	208+3110	\$6,40
3/16	45mm	208+3112	\$6,40
7/32	45mm	208+3114	\$6,40
1/4	26mm	272808	\$6,40
9/32	26mm	272809	\$6,40
5/16	26mm	272810	\$6,40
3/8	26mm	272812	\$6,40

3/8"			
3mm	50mm	308+2133	\$4,80
4mm	50mm	308+2134	\$4,80
5mm	50mm	308+2135	\$4,80
6mm	50mm	308+2136	\$4,80
7mm	50mm	310+2147	\$5,80
8mm	50mm	310+2148	\$5,80
9mm	50mm	339+2149	\$6,40
10mm	50mm	340+2150	\$6,40
9/32	50mm	310+3128	\$7,70
5/16	50mm	310+3130	\$7,70
3/8	50mm	312+3134	\$7,70
7/16	50mm	314+3138	\$7,70
1/2	50mm	316+3142	\$7,70

1/2"			
4mm	55mm	408+2134	\$4,80
5mm	55mm	408+2135	\$4,80
6mm	55mm	408+2136	\$4,80
7mm	55mm	410+2147	\$5,80
8mm	55mm	410+2148	\$5,80
9mm	55mm	439+2149	\$6,40
10mm	55mm	440+2150	\$6,40
12mm	55mm	442+2152	\$7,10
3/16	55mm	408+3112	\$7,90
7/32	55mm	408+3114	\$8,40
1/4	55mm	408+3116	\$8,40
5/16	55mm	410+3130	\$8,40
3/8	55mm	412+3134	\$8,40
7/16	55mm	414+3138	\$8,40
1/2	55mm	416+3142	\$8,40

KROMAJLI UZUN LOKMALI ALTİKÖŞE ALLENLER



1/4"			
1/16	100mm	208+3504	\$11,00
5/64	100mm	208+3505	\$11,00
3/32	100mm	208+3506	\$11,00
7/64	100mm	208+3507	\$11,00
1/8	100mm	208+3508	\$11,00
5/32	100mm	208+3510	\$11,00
3/16	100mm	208+3512	\$11,00
7/32	100mm	208+3514	\$11,00
1/4	100mm	208+3516	\$11,00

3/8"			
9/32	110mm	310+3518	\$11,00
5/16	110mm	310+3520	\$11,00
3/8	110mm	312+3524	\$11,00
7/16	110mm	314+3528	\$11,00
1/2	110mm	316+3532	\$11,00

1/2"			
4mm	110mm	408+2534	\$6,70
5mm	110mm	408+2535	\$6,70
6mm	110mm	408+2536	\$6,70
8mm	110mm	410+2548	\$7,40
10mm	110mm	440+2550	\$7,70
10mm	150mm	440+2650	\$10,50
11mm	80mm	441+2351	\$11,00
12mm	80mm	442+2352	\$11,00
12mm	110mm	442+2552	\$12,00
14mm	80mm	444+2354	\$9,40
17mm	80mm	447+2357	\$10,10
17mm	150mm	447+2657	\$15,70
19mm	150mm	449+2659	\$17,40
1/4	110mm	408+3516	\$7,90
5/16	110mm	410+3520	\$9,50
7/16	110mm	414+3528	\$10,00
1/2	110mm	416+3532	\$10,00
9/16	80mm	418+3336	\$10,00
5/8	80mm	420+3340	\$11,50
5/8	110mm	420+3540	\$13,00
3/4	80mm	424+3348	\$15,00

KROMAJLI KISA LOKMALI TORX ALLENLER



1/2"			
T-20	55mm	408+6120	\$5,80
T-25	55mm	408+6125	\$5,80
T-27	55mm	408+6127	\$5,80
T-30	55mm	408+6130	\$5,80
T-40	55mm	408+6140	\$6,30
T-45	55mm	410+6245	\$6,30
T-50	55mm	410+6250	\$7,10
T-55	55mm	440+6255	\$7,40

KROMAJLI UZUN LOKMALI TORX ALLENLER



1/4"

T-06	100mm	208+6506	\$11,00
T-07	100mm	208+6507	\$11,00
T-08	100mm	208+6508	\$11,00
T-09	100mm	208+6509	\$11,00
T-10	100mm	208+6510	\$11,00
T-15	100mm	208+6515	\$11,00
T-20	100mm	208+6520	\$11,00
T-25	100mm	208+6525	\$11,00
T-27	100mm	208+6527	\$11,00
T-30	100mm	208+6530	\$11,00
T-40	100mm	208+6540	\$11,00

3/8"

T-45	110mm	310+6545	\$11,00
T-50	110mm	310+6550	\$11,00
T-55	110mm	310+6555	\$11,00

KROMAJLI LOKMALI DÜZ TORNAVIDA UÇLARI



1/4"

0,8x4	26mm	222640	\$4,50
1x5,5	26mm	222655	\$4,50
1,2x6,5	26mm	222665	\$4,50
1,2x8	26mm	222680	\$4,50
1,6x10	26mm	222695	\$4,50

KROMAJLI LOKMALI YILDIZ TORNAVIDA UÇLARI



1/4"

Ph1	26mm	222601	\$4,70
Ph2	26mm	222602	\$4,70
Ph3	26mm	222603	\$4,70
Ph4	26mm	222604	\$4,70

KROMAJLI KISA LOKMALI DELİKLİ TORX ALLENLER



1/2"

T-20	55mm	408+7120	\$5,80
T-25	55mm	408+7125	\$5,80
T-27	55mm	408+7127	\$5,80
T-30	55mm	408+7130	\$5,80
T-40	55mm	408+7140	\$7,10
T-45	55mm	410+7145	\$7,10
T-50	55mm	410+7150	\$7,70
T-55	55mm	440+7155	\$8,40
T-60	60mm	442+7160	\$9,70
T-70	60mm	444+7170	\$9,70

KROMAJLI KARE LOKMALAR



1/4"

Ölçü mm	Boy mm	KISA
8	25	\$5,50
10	25	\$5,50

HAVALI TORX LOKMALAR



1/2"

Ölçü Ft x	Boy mm	KISA
E.8	38	\$5,60
E.10	38	\$5,60
E.11	38	\$5,60
E.12	38	\$5,60
E.14	38	\$5,60
E.16	38	\$5,60
E.18	40	\$6,30
E.20	40	\$6,70
E.22	40	\$7,20
E.24	40	\$7,50
E.26	44	\$12,50
E.28	44	\$12,50
E.30	46	\$12,50
E.32	46	\$12,50

3/4"

Ölçü Ft x	Boy mm	KISA
E.20	50	\$29,40
E.22	50	\$29,40
E.24	50	\$29,40

KROMAJLI UZUN LOKMALI DELİKLİ TORX ALLENLER



1/2"

T-30	80mm	408+7330	\$9,30
T-40	80mm	408+7340	\$9,30

KROMAJLI TORX LOKMALAR



1/4"		
Ölçü Ftx	Boy mm	KISA
E.4	22	\$4,60
E.5	22	\$4,60
E.6	22	\$4,60
E.7	22	\$4,60
E.8	22	\$4,60
E.10	22	\$4,60
3/8"		
Ölçü Ftx	Boy mm	KISA
E.10	28	\$6,20
E.11	28	\$6,20
E.12	28	\$6,20
E.14	28	\$6,20
E.16	28	\$6,20
E.18	28	\$6,20
E.20	28	\$6,20
1/2"		
Ölçü Ftx	Boy mm	KISA
E.10	38	\$8,20
E.11	38	\$8,20
E.12	38	\$8,20
E.14	38	\$8,20
E.16	38	\$8,20
E.18	40	\$8,20
E.20	40	\$8,20
E.22	40	\$8,20
E.24	40	\$8,20

1/2" SOKETLİ ALTİKÖŞE HAVALI LOKMALAR



Ölçü mm/inç	Boy mm	KISA	Boy mm	UZUN
8	38	\$2,80	78	\$5,60
9	38	\$2,80	78	\$5,60
10	38	\$2,80	78	\$5,60
11	38	\$2,80	78	\$5,60
12	38	\$2,80	78	\$5,60
13	38	\$2,80	78	\$5,60
14	38	\$2,80	78	\$5,60
15	38	\$2,80	78	\$5,60
16	38	\$2,80	78	\$5,60
17	38	\$3,00	78	\$5,60
18	38	\$3,50	78	\$6,00
19	40	\$3,50	78	\$6,20
20	40	\$3,90	78	\$6,50
21	40	\$3,90	78	\$6,40
22	42	\$4,40	78	\$7,60
23	42	\$4,80	78	\$7,90
24	44	\$4,80	78	\$7,90
25	44	\$5,30		
26	44	\$5,30	78	\$8,50
27	46	\$5,30	78	\$8,80
28	46	\$6,00	78	\$9,40
29	46	\$6,00	78	\$9,40
30	46	\$6,70	78	\$11,00
32	46	\$7,30	78	\$11,50
36	48	\$22,80	78	\$43,50
5/16	38	\$3,30	78	\$6,50
3/8	38	\$3,30	78	\$6,50
7/16	38	\$3,30	78	\$6,50
1/2	38	\$3,30	78	\$6,50
9/16	38	\$3,30	78	\$6,50
5/8	38	\$3,30	78	\$6,50
11/16	38	\$3,50	78	\$6,50
3/4	40	\$4,10	78	\$8,60
13/16	40	\$4,60	78	\$8,70
7/8	42	\$5,10	78	\$8,80
15/16	44	\$5,50	78	\$8,80
1	44	\$6,40	78	\$10,30
1.1/16	46	\$6,40	78	\$10,30
1.1/8	46	\$7,00	78	\$11,00
1.3/16	46	\$7,80	78	\$12,80
1.1/4	46	\$8,50	78	\$13,40

3/8" SOKETLİ ALTİKÖŞE HAVALI LOKMALAR



Ölçü mm/inç	Boy mm	KISA	Boy mm	UZUN
7	28	\$2,80		
8	28	\$2,80		
10	28	\$2,80	63	\$5,40
11	30	\$2,80	63	\$5,40
12	30	\$2,80	63	\$5,40
13	30	\$2,80	63	\$5,40
14	30	\$2,80	63	\$5,40
15	30	\$3,10	63	\$5,60
16			63	\$5,60
17	32	\$3,40	63	\$6,30
18			63	\$6,80
19	32	\$3,70	63	\$6,80
5/16	28	\$3,20		
3/8	28	\$3,20		
7/16	30	\$3,20		
1/2	30	\$3,20		
9/16	30	\$3,20		
5/8	30	\$3,90		
11/16	32	\$4,10		
3/4	32	\$5,10		

1/2" SOKETLİ YILDIZ HAVALI LOKMALAR



Ölçü mm	Boy mm	KISA
36	48	\$22,80

1/2" SOKETLİ ALTİKÖŞE MAFSALLI HAVALI LOKMALAR



Ölçü mm	Boy mm	KISA
19	66	\$27,50

3/4" SOKETLİ ALTİKÖŞE HAVALI LOKMALAR



Ölçü mm/inç	Boy mm	KISA	Boy mm	UZUN
17	51	\$11,40	90	\$16,20
18	51	\$11,40	90	\$16,20
19	51	\$11,40	90	\$16,20
20			90	\$16,20
21	51	\$11,40	90	\$16,20
22	51	\$11,40	90	\$16,20
23	51	\$11,40	90	\$16,20
24	51	\$11,40	90	\$16,20
26	54	\$11,40	90	\$16,20
27	54	\$11,40	90	\$16,20
28	54	\$11,40	90	\$16,70
29	54	\$11,40	90	\$17,10
30	54	\$11,40	90	\$17,10
32	57	\$12,30	90	\$17,10
33	57	\$12,30	90	\$18,40
34	57	\$12,30	90	\$18,40
35	57	\$12,80	90	\$21,00
36	57	\$13,20	90	\$21,00
38	57	\$13,70	90	\$22,80
40			90	\$27,20
41	58	\$15,20	90	\$27,20
42	58	\$23,70	90	\$29,80
43			90	\$29,80
45			95	\$29,80
46	63	\$23,70	95	\$29,80
50	68	\$25,80	100	\$36,80
52	70	\$28,90		
55	73	\$28,90	100	\$45,50
57	73	\$35,90		
58	73	\$35,90		
60	84	\$35,90	105	\$99,20
65	85	\$46,40	105	\$132,20
70	90	\$55,10		
75	90	\$206,80		
11/16	51	\$13,60		
3/4	51	\$13,60	90	\$17,50
13/16	51	\$13,60		
7/8	51	\$13,60	90	\$17,50
15/16	51	\$13,60	90	\$17,50
1	54	\$13,60	90	\$17,50
1,1/16	54	\$14,00		
1,1/8	54	\$14,00	90	\$21,90
1,1/4	57	\$14,00	90	\$21,90
1,5/16	57	\$14,90	90	\$23,80
1,3/8	57	\$14,90	90	\$26,30
1,7/16	57	\$16,70	90	\$28,00
1,1/2	57	\$16,70	90	\$28,00
1,5/8	58	\$17,70	90	\$39,40
1.11/16	60	\$21,20		
1,3/4	63	\$25,70		
1,7/8	65	\$25,70		
2	68	\$25,70		
2,1/16	70	\$25,70		
2,1/4	73	\$25,70		
2,5/16	73	\$33,80		
2,3/8	80	\$41,00		
2,1/2	80	\$47,00		

3/4" SOKETLİ YILDIZ HAVALI LOKMALAR



Ölçü mm	Boy mm	KISA
17	51	\$18,20
19	51	\$18,20
50	68	\$48,00
65	85	\$141,70

1" SOKETLİ KARE HAVALI LOKMALAR



Ölçü mm/inç	Boy mm	KISA	Boy mm	UZUN
17	60	\$29,80	90	\$34,30
19	60	\$29,80	90	\$34,30
21	60	\$29,80	90	\$34,30
22			90	\$34,30
3/4	60	\$29,80		
13/16	60	\$29,80		

1" SOKETLİ ALTİKÖŞE HAVALI LOKMALAR



Ölçü mm/inç	Boy mm	KISA	Boy mm	UZUN
17	60	\$16,30	90	\$21,50
19	60	\$16,30	90	\$21,50
20			90	\$21,50
21	60	\$16,30	90	\$21,50
22	60	\$16,30	90	\$21,50
23	60	\$16,30	90	\$21,50
24	60	\$16,30	90	\$21,50
25			90	\$21,50
26	60	\$16,30	90	\$21,50
27	60	\$16,30	90	\$21,90
28	60	\$16,30	90	\$21,90
29	60	\$16,30	90	\$21,90
30	62	\$16,30	90	\$21,90
31			90	\$23,70
32	63	\$16,30	90	\$23,70
33	63	\$17,50	90	\$23,70
34	63	\$17,50	90	\$24,50
35	63	\$17,50	90	\$26,30
36	67	\$18,90	90	\$26,30
38	67	\$19,90	90	\$30,70
41	70	\$21,50	90	\$32,40
42	70	\$25,90		
46	70	\$25,90	100	\$37,40
50	70	\$30,70	100	\$44,20

1" SOKETLİ ALTIKÖŞE HAVALI LOKMALAR



Ölçü mm/inç	Boy mm	KISA	Boy mm	UZUN
52	82	\$40,90		
55	87	\$40,90	110	\$57,80
57	87	\$50,80		
58	87	\$50,80		
60	91	\$50,80	110	\$75,30
63	91	\$56,90		
65	95	\$56,90	120	\$96,20
70	100	\$77,00	125	\$122,50
75	105	\$103,20	150	\$144,30
80	105	\$118,10	150	\$165,80
85	110	\$133,80	160	\$354,70
90	110	\$164,50	160	\$367,00
95	120	\$168,80	160	\$386,90
100	120	\$174,10		
105	120	\$360,20		
110	120	\$393,60		
115	120	\$466,90		
3/4	60	\$19,20		
13/16	60	\$19,20		
7/8	60	\$19,20		
15/16	60	\$19,20		
1	60	\$19,20		
1,1/16	60	\$19,20		
1,1/8	60	\$19,20		
1,3/16	62	\$19,20		
1,1/4	63	\$19,20		
1,5/16	63	\$21,00		
1,3/8	63	\$21,00		
1,7/16	67	\$22,80		
1,1/2	67	\$22,80		
1,5/8	70	\$26,30		
1,11/16	70	\$28,90		
1,3/4	70	\$29,80		
1,13/16	70	\$31,50		
1,7/8	70	\$33,30		
2	70	\$38,50		
2,1/16	82	\$38,50		
2,1/8	82	\$41,10		
2,3/16	87	\$60,40		
2,1/4	87	\$55,10		
2,5/16	87	\$56,40		
2,3/8	91	\$51,60		
2,7/16	91	\$66,50		
2,1/2	91	\$66,50		
2,5/8	95	\$76,10		
2,3/4	100	\$85,80		
2,7/8	100	\$131,20		
2,15/16	105	\$132,30		
3	105	\$135,80		
3,1/8	105	\$150,50		

1.1/2" SOKETLİ ALTIKÖŞE HAVALI LOKMALAR



Ölçü mm	Boy mm	KISA	Boy mm	UZUN
41	80	\$183,70	120	\$237,00
46	84	\$183,70	130	\$237,00
50	84	\$194,40		
55	90	\$198,60	150	\$316,00
60	90	\$206,60	150	\$329,00
65	95	\$223,00	150	\$360,00
70	100	\$245,80	150	\$394,00
75	105	\$264,40	160	\$424,00
80	110	\$302,40	170	\$485,00
85	110	\$339,10	170	\$545,00
90	112	\$369,60		
95	112	\$416,20		
100	115	\$451,10		
105	120	\$523,30		
110	124	\$531,90		
115	128	\$660,10		
120	132	\$661,90		
125	136	\$842,30		
130	140	\$1.212,90		
135	145	\$1.590,80		
140	150	\$2.401,20		
145	155	\$2.834,80		
150	160	\$3.301,70		

2.1/2" SOKETLİ ALTIKÖŞE HAVALI LOKMALAR



Ölçü mm	Boy mm	KISA
125	165	\$1.604,30

1/4" SOKETLİ ALTIKÖŞE KROMAJLI LOKMALAR



Ölçü mm/inç	Boy mm	KISA	Boy mm	UZUN
8			50	\$4,90
10			50	\$4,90
1/8	25	\$2,50		
1/4	25	\$2,50	50	\$8,20
19/32	25	\$2,50		



3/8" SOKETLİ ALTİKÖŞE KROMAJLI LOKMALAR



Ölçü mm/inç	Boy mm	KISA	Boy mm	UZUN
7	28	\$3,30		
8	28	\$3,30	63	\$8,40
9			63	\$8,40
10	28	\$3,30	63	\$8,40
11	30	\$3,30	63	\$8,40
12			63	\$8,40
13	30	\$3,30	63	\$8,40
14	30	\$3,30	63	\$8,40
15	30	\$4,20	63	\$9,70
16	30	\$4,20	63	\$9,70
17	32	\$4,20	63	\$9,70
18	32	\$4,20	63	\$9,70
19	32	\$4,20	63	\$9,70
1/4	28	\$4,20	63	
5/16			63	\$14,50
3/8			63	\$14,50
7/16			63	\$14,50
1/2			63	\$14,50
9/16			63	\$14,50
19/32	30	\$5,70	63	\$16,10
5/8			63	\$16,10
11/16			63	\$16,10
3/4			63	\$16,10
25/32	32	\$6,40	63	\$19,20
13/16	32	\$6,40	63	\$19,20
7/8	32	\$6,40	6	\$19,20

1/2" SOKETLİ ALTİKÖŞE KROMAJLI LOKMALAR



Ölçü mm/inç	Boy mm	KISA	Boy mm	UZUN
8	38	\$3,60	78	\$14,10
9	38	\$3,60	78	\$14,10
10	38	\$3,60	78	\$14,10
11	38	\$3,60	78	\$14,10
12	38	\$3,60	78	\$14,10
13	38	\$3,60	78	\$14,10
14	38	\$3,60	78	\$14,10
15	38	\$4,90	78	\$15,20
16	38	\$4,90	78	\$15,20
17	38	\$4,90	78	\$15,20
18	38	\$4,90	78	\$15,20
19	40	\$6,40	78	\$16,10
20	40	\$6,40	78	\$16,10
21	40	\$6,40	78	\$16,10
22	42	\$6,40	78	\$16,10
23	42	\$7,40	78	\$17,70
24	42	\$7,40	78	\$17,70
26	42	\$7,40	78	\$17,70
27	42	\$7,40	78	\$17,70
28	42	\$8,90	78	\$19,20
29	42	\$8,90		
30	42	\$8,90	78	\$19,20
32	42	\$8,90	78	\$19,20
36	44	\$14,50	78	\$32,30
5/16	38	\$4,90	78	\$14,50
3/8	38	\$4,90	78	\$14,50
7/16	38	\$4,90	78	\$14,50
1/2	38	\$4,90	78	\$14,50
9/16	38	\$4,90	78	\$14,50
5/8	38	\$6,40	78	\$16,10
11/16	38	\$6,40	78	\$16,10
3/4	40	\$6,40	78	\$16,10
13/16	40	\$8,90	78	\$19,20
7/8	42	\$8,90	78	\$19,20
15/16	44	\$8,90	78	\$19,20
1	44	\$8,90	78	\$19,20
1,1/16	46	\$10,60	78	\$19,80
1,1/8	46	\$10,60	78	\$19,80
1,3/16	46	\$10,60	78	\$22,10
1,1/4	46	\$10,60	78	\$25,60

1/2" SOKETLİ YILDIZ KROMAJLI LOKMALAR



Ölçü mm/inç	Boy mm	KISA	Boy mm	UZUN
8			78	\$14,10
10			78	\$14,10
13	38	\$3,60	78	\$14,10
14	38	\$3,60	78	\$14,10
17	38	\$4,90	78	\$15,20
19	40	\$6,40	78	\$16,10
22			78	\$19,20
24			78	\$19,20
27	46	\$7,40	78	\$19,20
30	46	\$8,90	78	\$19,20
32			78	\$19,20
1/2			78	\$14,50
9/16			78	\$14,50
11/16			78	\$16,10
3/4			78	\$16,10
13/16			78	\$19,20
15/16			78	\$19,20
1			78	\$19,20
1.1/8			78	\$19,20



3/4" SOKETLİ ALTİKÖŞE KROMAJLI LOKMALAR



Ölçü mm/inç	Boy mm	KISA	Boy mm	UZUN
17	51	\$16,10		
19	51	\$16,10		
22	51	\$16,10		
24	51	\$16,10	90	\$25,60
36	57	\$19,20		
50	68	\$41,60		
52	71	\$48,00		
55	75	\$48,00		
58	78	\$56,00		
60	80	\$56,00		
65	85	\$87,90		
70	90	\$103,90		
3/4	51	\$16,10		
15/16	51	\$16,10		
1,1/8	54	\$31,90		
1,1/4	57	\$31,90		
1,5/16	57	\$31,90		
1,3/8	57	\$31,90		
1,7/16	57	\$31,90		
1,1/2	57	\$35,20		
1,5/8	58	\$35,20		
1,3/4	63	\$40,10		
1,7/8	65	\$40,10		
2,1/16	70	\$40,10		
2,3/16	73	\$56,00		
2,1/4	73	\$56,00		
2,5/16	73	\$56,00		
2,3/8	80	\$56,00		
2,7/16	80	\$56,00		
2,1/2	80	\$56,00		
2,5/8	85	\$73,50		
2,3/4	90	\$73,50		

3/4" SOKETLİ YILDIZ KROMAJLI LOKMALAR



Ölçü mm/inç	Boy mm	KISA
17	51	\$16,10
19	51	\$16,10
21	51	\$16,10
22	51	\$16,10
23	51	\$16,10
24	51	\$16,10
27	54	\$19,20
30	54	\$19,20
32	57	\$19,20
35	57	\$19,20
36	57	\$19,20
41	58	\$35,20
46	63	\$40,10
50	68	\$48,00
54	73	\$48,00
55	73	\$48,00
58	73	\$56,00
60	80	\$56,00
65	85	\$114,90
70	90	\$114,90
7/8	51	\$16,10
15/16	51	\$16,10
1"	54	\$16,10
1,1/16	54	\$31,90
1,1/8	54	\$31,90
1,3/16	54	\$31,90
1,1/4	57	\$31,90
1,5/16	57	\$31,90
1,3/8	57	\$31,90
1,7/16	57	\$31,90
1,1/2	57	\$35,20
1,5/8	58	\$35,20
1,3/4	63	\$40,10
1,13/16	63	\$40,10
1,7/8	65	\$40,10
2	68	\$40,10
2,1/16	71	\$56,00
2,1/4	73	\$56,00
2,5/8	85	\$73,50
2,3/4	90	\$73,50

1" SOKETLİ ALTİKÖŞE KROMAJLI LOKMALAR



Ölçü mm/inç	Boy mm	KISA
36	67	\$61,30
38	67	\$61,30
41	70	\$61,30
43	70	\$61,30
46	70	\$61,30
50	70	\$63,80
54	82	\$67,10
55	87	\$67,10
58	87	\$79,90
60	91	\$79,90
63	91	\$87,90
65	95	\$87,90
70	100	\$103,90
75	105	\$111,80
80	105	\$127,60
85	110	\$183,60
90	110	\$231,50
95	120	\$306,30
100	120	\$382,80
105	120	\$510,40
110	120	\$558,40
115	120	\$630,20
2,1/4	87	\$95,70
2,5/16	87	\$95,70
2,3/8	91	\$103,90
2,7/16	91	\$111,80

1" SOKETLİ YILDIZ KROMAJLI LOKMALAR



Ölçü mm/inç	Boy mm	KISA
36	67	\$72,00
38	67	\$79,90
41	70	\$79,90
46	70	\$95,70
50	70	\$111,80
55	87	\$127,60
60	91	\$127,60
65	95	\$153,20
70	100	\$153,20
75	105	\$175,60
80	105	\$239,40
85	110	\$287,10
90	110	\$350,90
95	120	\$382,80
2,1/4	87	\$143,70
2,3/8	91	\$143,70
2,1/2	91	\$160,00
2,5/8	95	\$175,60
2,3/4	100	\$175,60
3,1/8	105	\$335,10

2,1/2	91	\$111,80
2,5/8	95	\$112,10
2,3/4	100	\$127,60
3,1/8	105	\$207,50



HİDROLİK MİL



8-01	10 Ton / G1/2" 12-4/5,18-2,20-2/20,30-2/20 41-5,42-5,205-02,206-02,207-02	€ 295,20
8-02	12 Ton / G3/4" 12-6/7,18-3,20-3/30,30-3 205-1/2/3,206-1/2/3,207-1/2/3	€ 338,30



8-1-B	15 Ton / G1" 11-0,18-4,20-4/40	€ 680,90
8-1-F	15 Ton / G1" 46-1/2,47-1/2	€ 702,40
8-2-K	20 Ton / G1.1/8" 11-1/2	€ 824,60
8-2-M	20 Ton / G1.1/8" 18-5,20-5	€ 951,30



800	10 Ton / G1.1/2" 128,129	€ 182,20
-----	-----------------------------	----------

ÇEKTİRME HİDROLİĞİ



9-1	10mm / 10 Ton	€ 210,50
9-2	15mm / 15 Ton	€ 261,40
9-3	7mm / 30 Ton	€ 793,50

ÜÇ AYAK ÇEKTİRME



11-0-A	375x200mm	€ 1.146,90
11-1-A	520x200mm	€ 1.349,50
11-2-A	650x200mm	€ 1.515,20

HİDROLİK MİLLİ ÜÇ AYAK ÇEKTİRME



11-0-B	15 Ton 375x200mm	€ 1.736,00
11-0-BV	15 Ton 375x300-500mm	€ 1.917,50
11-1-B	20 Ton 520x200mm	€ 2.352,90
11-2-B	20 Ton 650x200mm	€ 2.025,10

ÜÇ AYAK ÇEKTİRME



12-1	100x100mm	€ 159,60
12-2	150x125mm	€ 233,00
12-3	200x180mm	€ 341,60

İKİ AYAK ÇEKTİRME



14-1	6-100x85mm	€ 216,00
14-2	10-140x125mm	€ 309,30
14-3	15-140x160mm	€ 377,30

RULMAN İÇ ÇEKTİRME



16	60-155	€ 790,10
----	--------	----------

RULMAN ÇEKTİRME TABANI



15-0	5-60mm	€ 86,80
15-1	12-75mm	€ 111,70
15-2	22-115mm	€ 173,20
15-3	25-155mm	€ 280,00
15-4	30-200mm	€ 794,90
15-5	30-250mm	€ 1.132,90

RULMAN İÇ ÇEKTİRME



K-16	60-155mm	€ 834,80
------	----------	----------

RULMAN ÇEKTİRME TAKIMI



15-K	5-60mm	€ 289,10
15-A	12-75mm	€ 404,50
15-B	22-115mm	€ 491,60
15-C	25-155mm	€ 778,00
15-D	30-200mm	€ 1.861,80
15-E	30-250mm	€ 2.363,60

RULMAN ÇEKTİRME TABANI



17-0	5-60mm	€ 129,20
17-1	12-75mm	€ 168,40
17-2	22-115mm	€ 245,20
17-3	25-155mm	€ 395,60

RULMAN ÇEKTİRME TAKIMI



17-K	5-60mm	€ 348,50
17-A	12-75mm	€ 416,70
17-B	22-115mm	€ 599,10
17-C	25-155mm	€ 838,40

RULMAN ÇEKTİRME AYAĞI



18-1	15-1 için	€ 131,20
18-2	15-2 için	€ 194,60
18-3	15-3 için	€ 328,90
18-4	15-4 için	€ 987,90
18-5	15-5 için	€ 1.437,20

İKİ AYAK ÇEKTİRME



20-3-4	250X400	€ 474,60
20-4	520x200mm	€ 819,20
20-5	750x400-700mm	€ 3.063,80

İKİ AYAK ÇEKTİRME



20-1+	90x100mm	€ 133,20
20-10+	120x100mm	€ 158,20
20-2+	160x150mm	€ 210,20
20-20+	200x150mm	€ 230,70
20-3+	250x200mm	€ 455,10
20-30+	350x200mm	€ 450,60

HİDROLİK MİLLİ İKİ AYAK ÇEKTİRME



20-2+B	160x150mm 8-01 / 7 Ton	€ 504,60
20-20+B	200x150mm 8-01 / 7 Ton	€ 525,10
20-3+B	250x200mm 8-02 / 10 Ton	€ 992,80
20-30+B	350x200mm 8-02 / 10 Ton	€ 987,20
20-4-B	520x200mm 8-1-B / 15 Ton	€ 1.499,80

İKİ AYAK ÇEKTİRME



20-1+S	90x100mm	€ 192,00
20-10+S	120x100mm	€ 211,20
20-2+S	160x150mm	€ 325,70

İKİ AYAK ÇEKTİRME TAKIMI



20-ST+	20-1+/10+/2+/20+/3+	€ 1.084,20
--------	---------------------	------------

İKİ AYAK ÇEKTİRME TAKIMI



20-10-SP	120x100-350mm	€ 474,90
----------	---------------	----------

ÇEKTİRME AYAKLARI (2'Lİ TAKIMLAR)

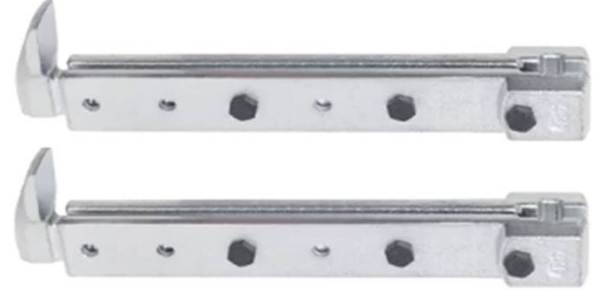

4-SP-P	300-500mm-20-3/30,20-4/40	€ 564,50
5-SP-P	400-700mm---20-5	€ 1.055,10



x-xx0-P

x-xx2-P

1-90-P	100mm--20-1/10	€ 58,70
1-190-P	200mm--20-1/10	€ 125,40
1-250-P	250mm--20-1/10	€ 159,90
2-150-P	150mm--20-2/20	€ 106,20
2-300-P	300mm--20-2/20	€ 192,10
3-200-P	200mm--20-3/30	€ 225,60
3-300-P	300mm--20-3/30	€ 273,60
3-400-P	400mm--20-3/30	€ 299,20
3-500-P	500mm--20-3/30	€ 329,60

1-92-P	100mm--20-1+/10+	€ 59,90
1-192-P	200mm--20-1+/10+	€ 125,40
1-252-P	250mm--20-1+/10+	€ 159,30
2-152-P	150mm--20-2+/20+	€ 112,80
2-302-P	300mm--20-2+/20+	€ 208,10
3-202-P	200mm--20-3+/30+	€ 276,80
3-302-P	300mm--20-3+/30+	€ 300,20
3-402-P	400mm--20-3+/30+	€ 316,20
3-502-P	500mm--20-3+/30+	€ 359,20



x-xx1-P

x-xx3-P

1-91-P	100mm--20-1S/10S	€ 76,40
1-191-P	200mm--20-1S/10S	€ 124,40
1-251-P	250mm--20-1S/10S	€ 135,50
2-151-P	150mm--20-2S/20S	€ 164,80
2-301-P	300mm--20-2S/20S	€ 262,70
3-201-P	200mm--20-3S/30S	€ 257,30
3-301-P	300mm--20-3S/30S	€ 305,60
3-401-P	400mm--20-3S/30S	€ 354,80
3-501-P	500mm--20-3S/30S	€ 515,00

1-93-P	100mm--20-1+S/10+S	€ 112,30
1-193-P	200mm--20-1+S/10+S	€ 141,70
1-253-P	250mm--20-1+S/10+S	€ 135,50
2-153-P	150mm--20-2+S/20+S	€ 164,80
2-303-P	300mm--20-2+S/20+S	€ 262,70
3-203-P	200mm--20-3+S/30+S	€ 275,90
3-303-P	300mm--20-3+S/30+S	€ 346,20
3-403-P	400mm--20-3+S/30+S	€ 385,10
3-503-P	500mm--20-3+S/30+S	€ 544,70

GENEL AMAÇLI ÇEKTİRME TAKIMI



K-20-15 € 1.498,50

İKİ VE ÜÇ AYAK ÇEKTİRME TAKIMI



K-2030 10+S+T 120-130x100-350mm € 761,60

PARÇALANMIŞ RULMAN ÇEKTİRMESİ



KS-22-01 3-10mm 1,70 Kg € 216,00

İÇ ÇEKTİRME

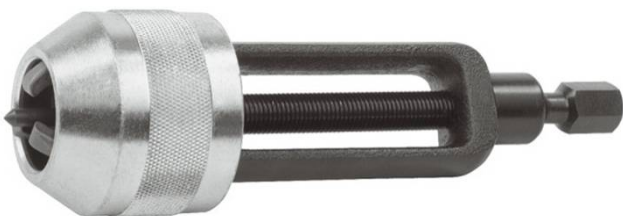

23 5-32mm € 225,20

RULMAN İÇ ÇEKTİRME TUTUCUSU



21-0	5-8mm / 22-1	€ 80,40
21-00	6-10mm / 22-1	€ 80,40
21-01	8-12mm / 22-1	€ 80,40
21-02	10-14mm / 22-1	€ 80,40
21-1	12-16mm / 22-1	€ 80,40
21-2	14-19mm / 22-1	€ 80,40
21-3	18-23mm / 22-1,22-2	€ 80,40
21-4	20-30mm / 22-1,22-2	€ 80,40
21-5	28-40mm / 22-1,22-2	€ 90,20
21-6	35-46mm / 22-2,22-3	€ 100,80
21-7	45-58mm / 22-2,22-3	€ 135,10
21-8	56-70mm / 22-2,22-3	€ 212,80
21-9	70-100mm / 22-3	€ 337,60
21-89	56-110mm / 22-4	€ 488,80
21-90	100-200mm / 22-5	€ 638,90

VURMALI TİP RULMAN İÇ ÇEKTİRME AYAĞI

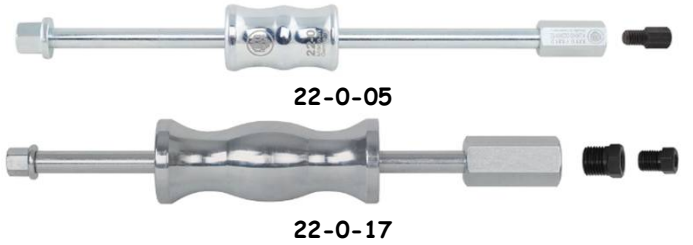

22-0-05	0,5kg 21-0...21-5	€ 81,20
22-0-17	1,7kg 21-3...21-9	€ 222,50

RULMAN İÇ ÇEKTİRME AYAĞI



22-1	21-0...21-5	€ 81,20
22-2	21-3...21-8	€ 110,80
22-3	21-6...21-9	€ 278,10
22-4	21-89	€ 334,00
22-5	21-90	€ 376,00

RULMAN ÇEKTİRME TAKIMI



24-A	21-1..21-6 22-1/2,23,43-1,20-1	€ 1.229,60
24-B	21-1..21-8 22-1/2,23,43-1,20-1/2	€ 1.798,20
24-C	21-1..21-7,21-89 22-1/2/4,23,43-1,20-1/2	€ 2.344,80

RULMAN İÇ ÇEKTİRME TAKIMI



K-22-A	21-00/02/2/3/4 22-0.22-1	€ 429,80
K-22-C-E	21-0E/00E/01E/1E/2E 21-3E/4E 22-0.22-1	€ 671,30

RULMAN İÇ ÇEKTİRME TAKIMI



25-K	6-19mm 21-00/02/2,22-1	€ 349,10
25-A	12-46mm 21-1..21-6,22-1/2	€ 767,50
25-B	12-70mm 21-1..21-8,22-1/2	€ 1.080,80
25-C	12-110mm 21-1..21-7/89,22-1/2/4	€ 1.598,20

VURMALI TİP RULMAN İÇ ÇEKTİRME TAKIMI



K-26-A	6-30mm 21-00/02/2/4,22-0-05/G-22	€ 373,40
26-B	6-40mm 21-00/01/1/2/4/5,22-0/0-1	€ 864,50

ÜÇ AYAK ÇEKTİRME



30-1+	90x100mm	€ 186,30
30-10+	130x100mm	€ 173,50
30-2+	160x150mm	€ 302,80
30-20+	200x150mm	€ 320,90
30-3+	250x200mm.	€ 618,90

HİDROLİK MİLLİ ÜÇ AYAK ÇEKTİRME



30-2+B	160x150mm 8-01 / 7 Ton	€ 597,20
30-20+B	200x150mm 8-01 / 7 Ton	€ 610,00
30-3+B	250x200mm 8-02 / 10 Ton	€ 958,10

GENEL AMAÇLI ÇEKTİRME TAKIMI

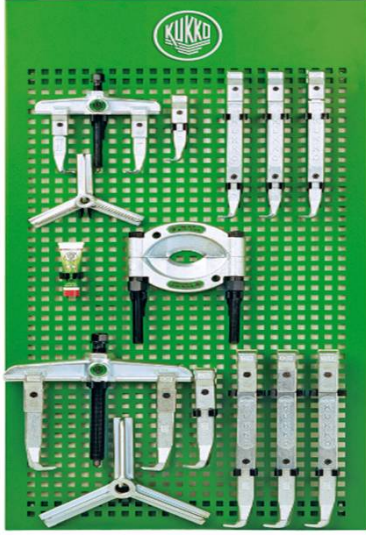

30-20-T	20-1/10,30-1/10 20-2/20/3,30-2/20/3	€ 1.463,70
---------	--	------------

KAMPANA ÇEKTİRMESİ



40-3	3 ayak / 225mm	€ 321,10
40-5	5 ayak / 225mm	€ 401,60

DİREKSİYON ÇEKTİRMESİ



31-1	30-60mm	€ 387,20
31-2	80-90mm	€ 387,20



32-1	100mm	€ 305,60
32-2	120mm	€ 402,80



33	Opel için	€ 176,90
----	-----------	----------

İKİ AYAK ÇEKTİRME



41-0	60x40mm	€ 37,40
41-1	65x65mm	€ 37,40
41-2	80x80mm	€ 42,90
41-3	90x120mm	€ 84,00

ÜÇ AYAK ÇEKTİRME



42-0	60x40mm	€ 50,00
42-1	65x65mm	€ 50,00
42-2	80x80mm	€ 59,90

İKİ VE ÜÇ AYAK İNCE AYAKLI ÇEKTİRME



43-001	60x50mm	€ 86,00
43-011	60x50mm	€ 108,80

İKİ AYAK ÇEKTİRME



44-1	100x100mm	€ 60,80
44-2	120x120mm	€ 96,70
44-3	160x160mm	€ 148,00
44-4	250x200mm	€ 204,80
44-5	300x250mm	€ 269,80

İKİ AYAK İNCE AYAKLI ÇEKTİRME



43-1	60x50mm	€ 51,60
43-2	70x70mm	€ 52,80
43-3	80x80mm	€ 54,40

ÜÇ AYAK ÇEKTİRME



45-1	100x100mm	€ 92,60
45-2	120x120mm	€ 138,60
45-3	160x160mm	€ 207,20
45-4	250x200mm	€ 292,20
45-5	300x250mm	€ 454,50

ÜÇ AYAK İNCE AYAKLI ÇEKTİRME



43-11	60x50mm	€ 65,30
43-12	70x70mm	€ 66,30
43-13	80x80mm	€ 70,50

İKİ AYAK ÇEKTİRME



46-1-A	300x300mm	€ 427,60
46-2-A	500x450mm	€ 541,10

HİDROLİK MİLLİ İKİ AYAK ÇEKTİRME



46-1-B	300x300mm 8-1-F / 15 Ton	€ 1.105,30
46-2-B	500x450mm 8-1-F / 15 Ton	€ 1.188,80

İKİ AYAK İNCE AYAKLI ÇEKTİRME



48	60x40mm	€ 63,00
----	---------	---------

ÜÇ AYAK ÇEKTİRME



47-1-A	300x300mm	€ 484,00
47-2-A	500x450mm	€ 644,10

TERS KILAVUZ TAKIMI



49-A	5 p. / 3-18mm	€ 30,80
49-B	6 p. / 3-24mm	€ 36,80
49-C	8 p. / 3-45mm	€ 74,20

HİDROLİK MİLLİ ÜÇ AYAK ÇEKTİRME



47-1-B	300x300mm 8-1-F / 15 Ton	€ 1.186,00
47-2-B	500x450mm 8-1-F / 15 Ton	€ 1.313,90

SAPLAMA SÖKECEĞİ



50-1	5-10mm	€ 69,80
50-2	8-19mm	€ 94,70
50-3	18-25mm	€ 106,40

SAPLAMA SÖKECEĞİ



51-1	5-10mm	€ 69,80
51-2	8-19mm	€ 106,40
51-3	18-25mm	€ 126,10



52	5-19mm	€ 173,40
----	--------	----------

SOMUN PATLATMA



54-2	10-27mm	€ 108,40
54-3	17-36mm	€ 176,40



55-0	4-10mm	€ 74,90
55-1	10-18mm	€ 90,00
55-2	19-27mm	€ 97,60
55-3	27-36mm	€ 157,10
55-4	32-50mm	€ 524,70

HİDROLİK SOMUN PATLATMA



56-1	7-24mm	€ 240,10
------	--------	----------



56-2	22-36mm	€ 444,00
56-2-C	22-36mm	€ 444,00



56-3	27-46mm	€ 810,90
------	---------	----------

ZİNCİR MONTAJ ÇEKTİRMESİ



58-1	9-46mm	€ 124,10
------	--------	----------

AMORTİSÖR YAY ÇEKTİRMESİ



65-0	200x110-180mm	€ 217,60
65-1	300x110-180mm	€ 239,60
65-2	400x110-180mm	€ 267,60



Çift tırnaklı		
66-1	100-250 x 110-180mm	€ 261,20
66-2	200-400 x 110-180mm	€ 275,20
66-3	100-400 x 110-180mm	€ 326,80

AMORTİSÖR YAY ÇEKTİRMESİ



67-1

80-195mm

€ 934,90

OTOMOTİV GRUBU ÇEKTİRME TAKIMI



K-65-A

€ 1.407,80

RULMAN İÇ ÇEKTİRME TAKIMI



70-K

6000..6013,6200..6207
6300..6306

€ 931,60

70-A

6000..6013,6200..6212,
6300..6311,6403..6408

€ 1.449,20

70-B

6014..6021,6213..6222,
6312..6317,6409..6415

€ 2.708,20



70-1-S

70-1 / 70-712 / 70-713

€ 357,60

70-2-S

70-2 / 70-721 / 70-722

€ 402,20

70-3-S

70-3 / 70-731 / 70-732

€ 645,20

RULMAN ÇEKTİRME TAKIMI



69-A

6004..6013,6201..6206
6300..6305

€ 415,30

69-B

6011..6020,6206..6212,
6305..6309,6403..6407

€ 564,00

69-C

6021..6032,6213..6230,
6310..6321,6406..6417

€ 1.206,10

RULMAN ÇAKMA TAKIMI



71

26-110mm

€ 2.400,00

71L

18-52mm

€ 1.328,00

DIŞ EĐESİ



97-1	DIN-ISO mm	€ 142,80
97-2	Whitworth+BSF	€ 142,80

KAYIŞLI FİLTRE ANAHTARI



104	180mm	€ 51,10
-----	-------	---------

SEGMAN YENGEÇİ



101-1	50-100mm	€ 61,20
101-2	90-150mm	€ 87,10

ZİNCİRLİ FİLTRE ANAHTARI



104-32	110mm	€ 87,30
--------	-------	---------

PİSTON PİM ÇIKARTMA



102-1	100mm	€ 212,40
-------	-------	----------

ÇEMBERLİ FİLTRE ANAHTARI



105-0	70-110mm / Saplı	€ 81,90
-------	------------------	---------

SUBAP İŞKENCESİ



103-1	60-230mm	€ 139,80
103-2	40-230mm	€ 158,50
103-3	115-290mm	€ 320,70



105-1	70-110mm/1/2" Soketli	€ 58,00
-------	-----------------------	---------

AHTAPOT (ÜÇ AYAK) FİLTRE ANAHTARI



108-1	3/8" / 60-100mm	€ 59,20
108-2	3/8" / 65-120mm	€ 59,20
108-3	1/2" / 90-140mm	€ 313,10

İKİ AYAK ÇEKTİRME



120-2	150x150mm	€ 163,90
120-3	250x200mm	€ 245,80
120-30	350x200mm	€ 292,90

JANT ÇEKTİRMESİ

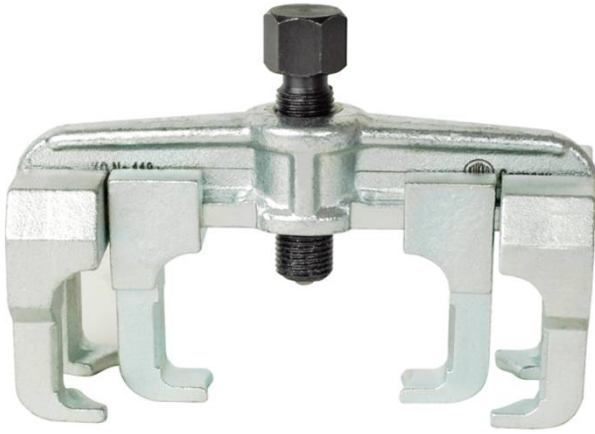

118-0	VW-Audi TDI	€ 268,50
-------	-------------	----------

PİSTON MERKEZLEME APARATI



126-00	€ 196,50
--------	----------

EGZOST YAY ÇEKTİRMESİ

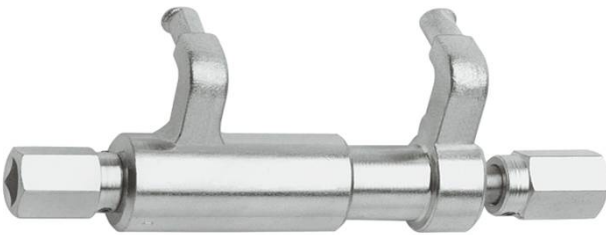

119-0	VW	€ 125,30
-------	----	----------

EGZOST MANİFOLT AYAR APARATI



119-1	VW	€ 77,90
-------	----	---------



126-30	€ 454,30
--------	----------

ROT BAŞI ÇEKTİRMESİ



128-1	18mm	€ 52,80
128-2	23mm	€ 72,00
128-3	29mm	€ 95,70
128-4	39mm	€ 128,10
128-5	50mm	€ 234,40

ROT BAŞI ÇEKTİRMESİ



129-0	20mm	€ 137,10
-------	------	----------



129-1	18-22mm	€ 106,20
-------	---------	----------



129-2	16-22-32mm	€ 132,20
-------	------------	----------



129-3	34mm	€ 178,20
129-4	40mm	€ 237,60



129-5	36mm	€ 431,50
-------	------	----------

HİDROLİK MİLLİ ROT BAŞI ÇEKTİRMESİ



129-4-H	36-40mm 801 / 10 Ton	€ 647,70
---------	-------------------------	----------

ROT ATTIRMA KOLU (ÇATALI)



135-1	18mm	€ 70,40
135-2	23mm	€ 70,40
135-3	29mm	€ 70,40
135-4	39mm	€ 70,40
135-5	45mm	€ 70,40

MİKRO ÇEKTİRME



140-1	10x10mm	€ 44,00
140-2	15x15mm	€ 44,00
140-3	18x18mm	€ 44,00

ÜÇ AYAK ÇEKTİRME



202-0	100x75mm	€ 81,20
202-1	150x85mm	€ 101,20
202-2	220x130mm	€ 175,10
202-3	300x260mm	€ 346,90
202-4	380x300mm	€ 397,20

SİLECEK ÇEKTİRMESİ



142-1	15mm	€ 147,20
-------	------	----------

ÜÇ AYAK ÇEKTİRME



202-S	200x200mm	€ 160,40
-------	-----------	----------

SPESYAL ÇEKTİRME



145-2	m10 / 75mm-Boy	€ 60,80
145-3	m12 / 90mm-Boy	€ 71,60

İKİ AYAK ÇEKTİRME



201-0	100x75mm	€ 63,10
201-1	150x85mm	€ 90,00
201-2	220x130mm	€ 137,10
201-3	300x260mm	€ 269,20
201-4	380x300mm	€ 317,20

ÜÇ AYAK ÇEKTİRME



203-0	120x75mm	€ 87,90
203-1	180x85mm	€ 107,50
203-2	280x130mm	€ 182,50
203-3	350x260mm	€ 405,40
203-4	400x300mm	€ 454,80

İKİ AYAK ÇEKTİRME



205-00	100x100mm	€ 53,90
205-01	150x150mm	€ 93,30
205-02	250x220mm	€ 124,10
205-1	300x280mm	€ 247,30
205-2	400x400mm	€ 334,80
205-3	500x540mm	€ 421,60
205-65	650x650mm	€ 1.183,40

İKİ AYAK KİLİTLİ ÇEKTİRME



204-0	50x70mm	€ 131,20
204-02	90x100mm	€ 202,80
204-1	80x90mm	€ 148,00
204-2	100x100mm	€ 169,30
204-3	150x140mm	€ 275,20

HİDROLİK MİLLİ İKİ AYAK ÇEKTİRME



205-02-B	250x220mm 8-01 / 7 Ton	€ 410,00
205-1-B	300x280mm 8-02 / 10 Ton	€ 572,60
205-2-B	400x400mm 8-02 / 10 Ton	€ 665,00
205-3-B	500x540mm 8-02 / 12 Ton	€ 820,80

İKİ AYAK ÇEKTİRME TAKIMI



K-204-V-210-1	204-2 210-1	€ 445,50
---------------	----------------	----------

ÜÇ AYAK ÇEKTİRME



206-00	100x100mm	€ 72,40
206-01	150x150mm	€ 96,10
206-02	250x220mm	€ 161,40
206-1	300x280mm	€ 305,60
206-2	400x400mm	€ 410,00
206-3	500x540mm	€ 527,20

ÜÇ AYAK ÇEKTİRME



207-00	120x100mm	€ 75,50
207-01	200x150mm	€ 101,80
207-02	300x220mm	€ 169,30
207-1	400x280mm	€ 360,40
207-2	450x400mm	€ 438,00
207-3	550x540mm	€ 587,00
207-65	650x650mm	€ 1.536,00

HİDROLİK MİLLİ ÜÇ AYAK ÇEKTİRME



206-02-B	250x220mm 8-01 / 7 Ton	€ 445,70
206-1-B	300x280mm 8-02 / 10 Ton	€ 630,40
206-2-B	400x400mm 8-02 / 10 Ton	€ 725,40
206-3-B	500x540mm 8-02 / 12 Ton	€ 926,40

HİDROLİK MİLLİ ÜÇ AYAK ÇEKTİRME



207-02-B	300x170mm 8-01 / 7 Ton	€ 454,00
207-1-B	400x230mm 8-02 / 10 Ton	€ 682,90
207-2-B	450x350mm 8-02 / 10 Ton	€ 758,50
207-3-B	550x490mm 8-02 / 12 Ton	€ 942,70

İKİ AYAK ÇEKTİRME



208-0



208-01/02

208-0	100x50-75-100mm	€ 43,90
208-01	20-170x95-125mm	€ 88,80
208-02	20-230x150-190mm	€ 119,30

ÜÇ AYAK ÇEKTİRME



209-0

209-01/02

209-0	100x50-75-100mm	€ 59,90
-------	-----------------	---------

209-01	20-170x95-125mm	€ 104,80
209-02	20-230x150-190mm	€ 155,60

İKİ AYAK KİLİTLİ ÇEKTİRME



210-1	95x170mm	€ 248,30
210-2	135-270mm	€ 309,20
210-3	150x325mm	€ 354,80

İKİ VE ÜÇ AYAK VURMALI ÇEKTİRME



220	0-130mm	€ 686,80
-----	---------	----------

VURMALI ÇEKTİRME TAKIMI



223-K	3-16mm	€ 331,70
-------	--------	----------

ÜÇ AYAK OTOMATİK ÇEKTİRME



225-1	m10 / 75mm-Boy	€ 377,60
225-2	m12 / 90mm-Boy	€ 377,60
225-3	m10 / 75mm-Boy	€ 377,60

FLANŞ TIPI AKS ÇEKTİRMESİ



230

Flanş çapı 100-150mm
Aks civata ölçüsü 4-14mm

€ 229,70

VURMALI ÜÇ AYAK ÇEKTİRME



243-12

70x70mm

€ 216,20

ÜÇ AYAK ÇEKTİRME



483-3

150x150mm

€ 212,50

KASNAK DİŞLİ SABİTLEME APARATI



T-143

€ 244,30

PARÇA TUTMA İŞKENCESİ



1900-30

30mm

€ 102,40

1900-50

50mm

€ 118,40

1900-75

75mm

€ 172,80

SPESYAL ÇEKTİRME TAKIMI



K-142/4

43/1, 128-F-SW
142/1, 142/4

€ 371,30



K-142/6

43/1, 128-F-SW
142/1, 142/2
142/3, 142/4
1007-16, 228-100

€ 585,20

HİDROLİK ÜÇ AYAK ÇEKTİRME



8-HP-626
& 45-5

300x250mm
12 Ton

€ 1.609,00

8-HP-626

12 Ton / G3/4"
12-4,18-3,20-3/30,30-3/30
45-4/5,201-3/4,202-3/4,203-3/4
205-1/2/3,206-1/2/3,207-1/2/3

€ 1.129,00

HİDROLİK ÇEKTİRMELER İÇİN POMPA



YHP-326

2mt Hortumu ve
Manometresi ile birlikte
Metal sandıkta

€ 1.321,80

HİDROLİK İKİ VE ÜÇ AYAK ÇEKTİRME TAKIMI



Y28-256

500x300mm
20 Ton

€ 4.889,00

Y38-356

900x520mm
30 Ton

€ 7.602,20

Y58-556

1200x700mm
50 Ton

€ 12.812,90

HİDROLİK İKİ-ÜÇ AYAK VE RULMAN ÇEKTİRME TAKIMI



Y28-200

500x300mm
Rulman 25x155mm
20 Ton

€ 9.007,90

Y38-300

900x520mm
Rulman 30x250mm
30 Ton

€ 13.145,50

Y58-500

1200x700mm
Rulman 75x330mm
50 Ton

€ 22.471,50

HİDROLİK İÇ VE DIŞ RULMAN ÇEKTİRME TAKIMI



Y28-218

140x30-180mm
Rulman 25x155mm
20 Ton

€ 6.125,10

Y38-318

150x75-230mm
Rulman 30x250mm
30 Ton

€ 10.099,90

Y58-518

150x75-230mm
Rulman 75x330mm
50 Ton

€ 16.341,60



ALTIKÖŞE ALLEN ANAHTAR TAKIMI



203-110 ALTIKÖŞE
10 parça / 0,05-3/8 € 11,80



205-104 ALTIKÖŞE
7 parça / 2,5-10mm € 22,80

205-109 ALTIKÖŞE
7 parça / 3/32-3/8 € 24,70



204-990 ALTIKÖŞE
9 parça / 3/32-9/16 € 54,70



207-011 ALTIKÖŞE - UZUN
8 parça / 2-10mm € 39,60

207-012 ALTIKÖŞE - UZUN
8 parça / 5/64-3/8 € 39,70

BOMBE BAŞLI ALTIKÖŞE ALLEN ANAHTAR TAKIMI



215-003 BOMBE BAŞ ALTIKÖŞE
9 parça / 1,5-10mm € 34,90

TORX ALLEN ANAHTAR TAKIMI



211-505 TORX
8 parça / T.09-T.40 € 36,10



212-258 TORX
8 parça / T.09-T.40 € 37,80



212-260 BOMBE BAŞ TORX
8 parça / T.09-T.40 € 63,00

ALTIKÖŞE ALLEN ANAHTAR

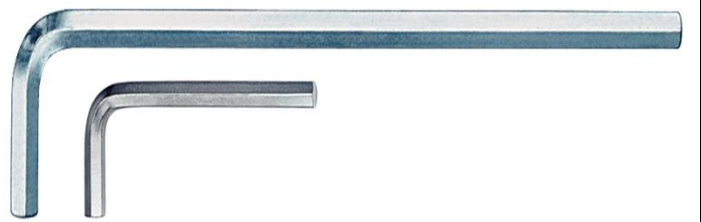

201-018 18mm - KISA
84x188mm € 18,00

201-020 20mm - KISA
90x200mm € 23,20

201-021 21mm - KISA
96x211mm € 30,80

204-014 14mm - UZUN
70x294mm € 17,10

204-022 22mm - UZUN
102x422mm € 60,70

204-024 24mm - UZUN
114x422mm € 87,90

204-027 27mm - UZUN
127x527mm € 138,00

TURNUS

CIRCIRLI KILAVUZ KOLU



280-085	KISA No:1 m3-10 85mm	€ 16,80
280-100	KISA No:2 m5-12 100mm	€ 20,80
280-250	UZUN No:1 m3-10 250mm	€ 26,40
280-300	UZUN No:2 m5-12 300mm	€ 33,30

İŞKENCE



420-028	28x25mm	€ 31,20
420-053	53x38mm	€ 38,70
420-078	78x50mm	€ 46,50
420-105	105x60mm	€ 60,80
420-130	130x70mm	€ 78,80
420-155	155x76mm	€ 87,40
420-206	206x86mm	€ 112,00

OTOMATİK İŞKENCE



472-012	120x60mm	€ 52,70
472-016	160x80mm	€ 57,50
472-020	200x100mm	€ 66,70
472-025	250x120mm	€ 76,40
472-030	300x140mm	€ 90,80
472-040	400x120mm	€ 95,40
472-050	500x120mm	€ 102,20
472-060	600x120mm	€ 106,30
472-080	800x120mm	€ 128,40
472-100	1000x120mm	€ 142,60

OTOMATİK İŞKENCE



485-010	100x80mm	€ 48,10
485-020	200x80mm	€ 53,20

İŞKENCE



473-020	200x120mm	€ 98,50
473-025	250x120mm	€ 100,60
473-030	300x120mm	€ 106,30
473-040	400x120mm	€ 113,00
473-050	500x120mm	€ 120,60
473-060	600x120mm	€ 125,20

ALLEN TORNAVİDA



171S-0,7mm	60-140mm	€ 8,90
171S-0,9mm	60-140mm	€ 8,90
171S-1,3mm	60-140mm	€ 8,90
171S-1,5mm	60-140mm	€ 8,90

AYARLI PENSE



690-125	125mm	€ 28,90
---------	-------	---------



691-250	250mm	€ 39,70
---------	-------	---------



692-250	250mm	€ 57,10
---------	-------	---------

CONTA KESME PERGELİ

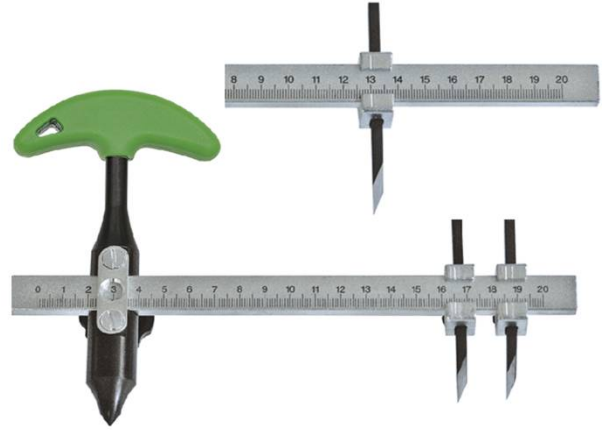

321-200	Tek Bıçak 200mm	€ 69,80
---------	--------------------	---------

321-400	Tek Bıçak 400mm	€ 81,20
---------	--------------------	---------

321-600	Tek Bıçak 600mm	€ 94,80
---------	--------------------	---------

322-200	Çift Bıçak 200mm	€ 106,80
---------	---------------------	----------

322-400	Çift Bıçak 400mm	€ 120,10
---------	---------------------	----------

322-600	Çift Bıçak 600mm	€ 138,60
---------	---------------------	----------

SAC MAKASI



978-300	300mm Sağ	€ 50,20
---------	-----------	---------

978-301	300mm Sol	€ 50,20
---------	-----------	---------

ÇAKMALI HARF



329-202	2mm	€ 37,80
---------	-----	---------

329-203	3mm	€ 39,10
---------	-----	---------

329-204	4mm	€ 42,90
---------	-----	---------

329-205	5mm	€ 47,30
---------	-----	---------

329-206	6mm	€ 51,30
---------	-----	---------

329-208	8mm	€ 69,40
---------	-----	---------

329-210	10mm	€ 91,60
---------	------	---------

329-212	12mm	€ 110,10
---------	------	----------

ÇAKMALI RAKAM



328-102	2mm	€ 12,40
---------	-----	---------

328-103	3mm	€ 12,70
---------	-----	---------

328-104	4mm	€ 13,80
---------	-----	---------

328-105	5mm	€ 15,20
---------	-----	---------

328-106	6mm	€ 16,40
---------	-----	---------

328-108	8mm	€ 22,30
---------	-----	---------

328-110	10mm	€ 29,50
---------	------	---------

328-112	12mm	€ 34,90
---------	------	---------



IRWIN VISE-GRIP



AMERICAN TOOLS - IRVIN

WR - STANDART TİP AYARLI PENSE



4"-100mm

4 WR

\$21,20

5"-125mm

5 WR

\$21,20

10"-250mm

10 WR

\$24,10

RR - DÜZ BIÇAK AĞIZLI TİP AYARLI PENSE



7"-175mm

7 RR

\$36,10

LN - UZUN AĞIZLI TİP AYARLI PENSE



6"-150mm

6 LN

\$30,80

AC - KAYNAKÇI TİP AYARLI PENSE



9"-225mm

9 AC

\$43,70

LW - SOMUN İÇİN AYARLI PENSE



10"-250mm

10LW

\$25,30

R - KİLİTLİ TİP ZİNCİRLİ BORU ANAHTARI



9"-225mm

20 R

\$43,70

SP - C TİPİ MAFSALLI AĞIZLI AYARLI PENSE



4"-100x41mm

4 SP

\$24,10

AMERICAN TOOLS - IRVIN

R - C TİPİ STANDART AĞIZLI AYARLI PENSE



6"-150x50mm

6 R

\$24,10

11"-275x100mm

11 R

\$31,70

18"-455x200mm

18 R

\$46,70

GJP- FORT PENSE



10"-250mm

10 GJP

\$34,70

12"-300mm

12 GJP

\$40,70

GLGJP- KİLİTLİ TİP FORT PENSE



10"-250mm

10 GLGJP

\$54,20

12"-300mm

12 GLGJP

\$67,70

SAC MAKASI



9,1/2"-240mm

20 SL

\$39,10

TEL KESKİSİ



7,1/2"-190mm

Yumuşak çelik:6,5mm-Sert çelik: 5mm

Çelik parça:4mm

Yay çeliği:2,5mm-Elektrik kablosu:6,5mm

6TWC

\$67,70

AMERICAN TOOLS - IRVIN

KADEMELİ MATKAP



4-22mm
2mm Aralıklı

Unibit- 4

\$66,90

5-35mm
2-3mm Aralıklı

Unibit- 5

\$143,50

PLASTİK STANDLI ALLEN ANAHTAR TAKIMI



ALTIKÖŞE
1,5-10mm /9'lu

98040

\$9,00

ÇAKI TİPİ ALLEN ANAHTAR TAKIMI



ALTIKÖŞE
2-8mm /7'li

98027

\$18,10

ALTIKÖŞE
5/64"-1/4" /9'lu

98091

\$19,70

TORX
T.6-T.25 /8'li

98055

\$30,10

TORX
T.30-T.55 /5'li

98058

\$49,80

POŞETLİ ALLEN ANAHTAR TAKIMI



ALTIKÖŞE
2-8mm /7'li

88060

\$8,00

TORX
T.10-T.50 /9'lu

88185

\$62,60

TORX
T.7-T.55 /13'li

88186

\$78,50



DICK



KUYUMCU MAKASI



Tipi Düz-Yaysız
Boy 180mm

85-40851810

€ 17,20

ELEKTRONİKÇİ YANKESKİ



Tipi Yaylı
Boy 120mm

180E-41180070

€ 35,00

KUYUMCU MAKASI



Tipi Düz-Yaylı
Boy 180mm

85F-40851820

€ 19,00

ELEKTRONİKÇİ KARGABURUN



Tipi Yaylı
Boy 120mm

183E-41183070

€ 24,60

KUYUMCU MAKASI



Tipi Eğri
Boy 180mm

87-40871860

€ 21,40

İĞNE PENSESİ



Tipi Düz
Boy 180mm

40151280

€ 29,20

KAPORTACI EĞESİ



Cinsi KOMPLE
Boy 350mm

14143510
14193500

€ 67,70

Cinsi SAP
Boy 350mm

14193500

€ 36,20

Cinsi Yedek eğe
Boy / Diş 350mm - 9"

14143510

€ 32,70

Tipi Yedek eğe
Boy / Diş 350mm - 12"

14143520

€ 35,00

LAMA ALÜMİNYUM EĞE



Boy 250mm

33082500

€ 24,10

YARIM YUVARLAK ALÜMİNYUM EĞE



Boy 250mm

14042520

€ 29,00

GENEL AMAÇLI EĞE

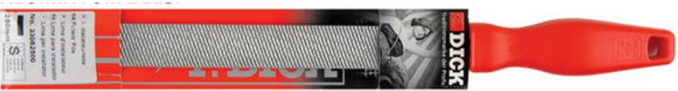

Boy 250mm

33052500

€ 11,50

TESVİYECİ EĞE TAKIMI



Boy 200mm

13142020

€ 39,80

ELMAS EĞE



Tipi Üçgen
Boy 160mm

23321600

€ 19,30

Tipi Lama
Boy 160mm

23121600

€ 21,80

Tipi Kare
Boy 160mm

23421600

€ 19,30

Tipi Yuvarlak
Boy 160mm

23621600

€ 17,50

Tipi Yarım yuvarlak
Boy 160mm

23521600

€ 20,00

ELMAS EĞE TAKIMI



Parça adedi 5 parça
Boy 160mm
Üçgen + Lama + Kare + Yuvarlak +
Yarım yuvarlak

23001600

€ 98,10

DÜZ SAATÇİ TORNAVİDA TAKIMI



Düz ağızlı 6 parçalı takım

40918000-918

€ 22,30

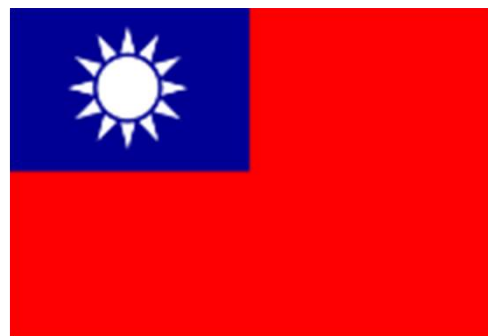
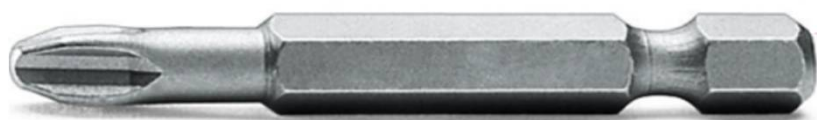

BITS UÇ VE ADAPTÖRLERİ

YILDIZ TORNAVİDA UÇLARI



1/4" - 25mm
Ph0-1-2-3-4

\$0,50

1/4" - 50mm
Ph1-2-3-4

\$0,90

1/4" - 70mm
Ph1-2

\$1,50

1/4" - 90mm
Ph1-2

\$1,70

1/4" - 150mm
Ph2

\$4,20

ALLEN TORNAVİDA UÇLARI



1/4" - 30mm
m2-2,5-3-4
5-5,5-6-7

\$1,20

1/4" - 50mm
m2-2,5-3-4-5-6

\$2,30

DELİKLİ TORX TORNAVİDA UÇLARI



1/4" - 25mm
T.20

\$1,80

DÜZ TORNAVİDA UÇLARI



1/4" - 25mm
No:3-4-5-6-8

\$0,90

1/4" - 50mm
No:3-4-5-6-7

\$1,50

1/4" - 90mm
No:6x8-8x10
10x12-12x14

\$2,30

BOMBE BAŞ ALLEN TORNAVİDA UÇLARI

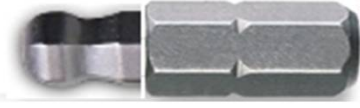

1/4" - 30mm
m2,5-3-4-5-6

\$1,80

KARE TORNAVİDA UÇLARI

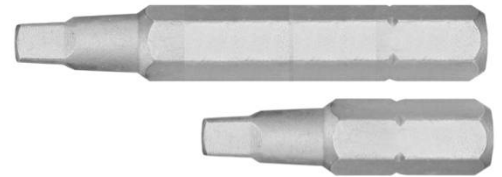

1/4" - 25mm
S-0 (2mm)
S-1 (2,5mm)
S-2 (3mm)
S-3 (4,5mm)

\$1,20

1/4" - 50mm
S-3 (4,5mm)

\$2,30

TORX TORNAVİDA UÇLARI



1/4" - 25mm
T.7-8-9-10-15
20-25-27-30-40

\$1,20

1/4" - 50mm
T.8-9-10-15-20
25-27-30-40

\$2,30

1/4" - 70mm
T.30-40

\$5,80

BULUCULU DÜZ TORNAVİDA UÇLARI



1/4" - 95mm
No:2-3-4

\$7,30

BITS UÇ VE ADAPTÖRLERİ

DARBELİ YILDIZ TORNAVİDA UÇLARI



5/16"-30mm
Ph2-3-4

\$2,60

DARBELİ DÜZ TORNAVİDA UÇLARI



5/16"-30mm
No:5-6-8-10-12

\$2,60

DARBELİ TORX TORNAVİDA UÇLARI



5/16"-30mm
T.40

\$4,60

MANYETİK UÇ ADAPTÖRLERİ



1/4"-60mm

\$9,20

1/4"-60mm

İnox

\$11,50

TORNAVİDA İÇİN LOKMA ANAHTAR



1/4"-40mm
m5,5-6-7
8-10-12-13

\$4,60

1/4"-65mm
m5,5-6-7
8-10-12-13

Manyetik

\$9,20

SOMUN SIKMA İÇİN UÇ ADAPTÖRLERİ



1/4"-1/4"
35mm

\$6,90

3/8"-1/4"
39mm

\$9,20

3/8"-5/16"
39mm

\$9,20

1/2"-1/4"
41mm

\$10,40

1/2"-5/16"
41mm

\$10,40

TORNAVİDA İÇİN LOKMA ADAPTÖRLERİ



1/4"-1/4"
30mm

\$4,60

1/4"-1/4"
65mm

\$5,20

1/4"-1/4"
100mm

\$6,90

1/4"-3/8"
65mm

\$6,00

1/4"-1/2"
65mm

\$8,10

LASER[®]
— TOOLS —

carolus 
by **GEDORE**



LASER

3/8" SOKETLİ AÇIK AĞIZ ANAHTAR TAKIMI



Soket	3/8"
Parça sayısı	10
Muhteviyatı	m10-11-13-14-15 16-17-18-19-22

3282

€ 85,00

CAROLUS

1/4" SOKETLİ LOKMA ANAHTAR TAKIMI



Soket	1/4"
Parça sayısı	13
Muhteviyatı	m4-5-6-7-8-10 11-12-13 Lokma Circir kol+Uç adp. Uzatma (2)

7400

€ 35,00

MATKAP UÇLU VİDA

MATKAP UÇLU (AKILLI) VİDA



Dın	7504N
1.000 adetlik Poşetlerde Poşet fiyatıdır.	
Kolisi 20.000 adetdir.	

3,9x16 YSB

\$10,80



Record®



HAZET®



RECORD

STILSON TİPİ BORU ANAHTARI



300/10	10" - 250mm	€ 17,60
300/12	12" - 300mm	€ 20,90
300/14	14" - 350mm	€ 24,20
300/18	18" - 450mm	€ 35,20
300/24	24" - 600mm	€ 52,80

HAZET

SUBAP AYAR ANAHTARI



2769-1

€ 46,00

SUBAP YAY BASACAĞI



2577-1

€ 88,60

MAFSALLI LOKMA ANAHTAR TAKIMI



Soket 1/2"
Ölçüler m10-13-14-17-19

900 G/5

€ 195,50



 **Eastman**®



İZOLELİ PENSE



6" - 150mm

\$3,30

7" - 180mm

\$4,30

8" - 200mm

\$4,40

İZOLELİ YANKESKİ



6" - 150mm

\$3,70

7" - 180mm

\$3,90

İZOLELİ KARGABURUN



6" - 150mm

\$3,70

7" - 180mm

\$3,90

8" - 200mm

\$4,00

İZOLELİ KERPETEN



6" - 160mm

\$3,70

10" - 250mm

\$4,20

STİLSON TİPİ BORU ANAHTARI



14" - 350mm

\$7,00

18" - 450mm

\$12,60

24" - 600mm

\$23,10

DEMİR TESTERE KOLU



10 adet Yedeği ile

\$5,00

KOMBİNE ANAHTAR TAKIMI



6-32mm / 12'li

\$18,70

AĞIR TİP BORU ANAHTARI



14" - 350mm

\$14,30

EL GRES POMPASI



500cc

\$20,90

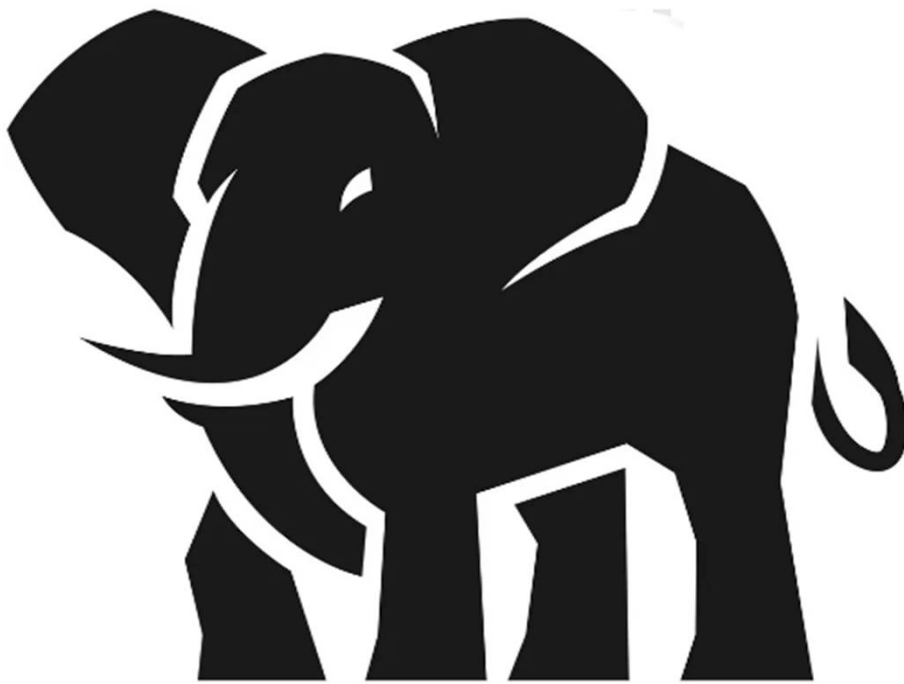

ELEPHANT

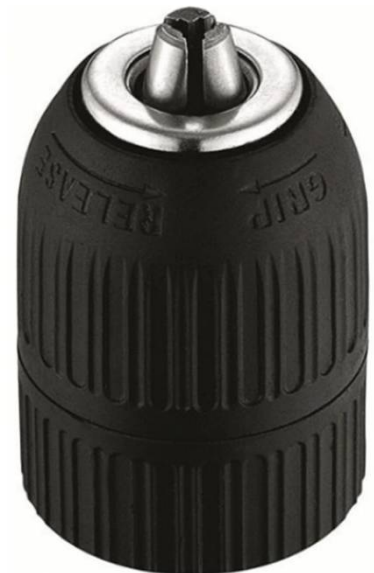

ANAHTARLI MANDREN



10mm	3/8"-24 dişli	\$7,10
10mm	1/2"-20 dişli	
13mm	3/8"-24 dişli	\$8,50
13mm	1/2"-20 dişli	
13mm	B.16 konik	
16mm	1/2"-20 dişli	\$12,70
16mm	B.16 konik	
16mm	B.18 konik	
20mm	B.22 konik	\$28,90

ELLE SIKMALI MANDREN



10mm	3/8"-24 dişli	\$28,10
10mm	1/2"-20 dişli	
13mm	1/2"-20 dişli	\$37,90
13mm	B.16 konik	
16mm	B.18 konik	\$43,80

MANDREN ANAHTARI



No.:1	\$1,70
No.:2	\$2,20

ELLE SIKMALI PLASTİK MANDREN



10mm	3/8"-24 dişli	\$9,40
13mm	3/8"-24 dişli	\$11,50
13mm	1/2"-20 dişli	

DÖNER PUNTALAR



3 Mors	\$52,60
4 Mors	\$68,10
5 Mors	\$92,30



SIMPLEX®



SIMPLEX

MEKANİK CIRCIRLI VAGON KRİKOSU



Kapasite	5 Ton
Strok	330mm
İnik Haldeki Boyu	508mm
İnik Haldeki	46mm
Tırnak Boyu	
Taban Ölçüleri	127x187mm
Ağırlığı	15,75 Kg

RJ 86 A

\$1.373,00

MEKANİK CIRCIRLI VAGON KRİKOSU



Kapasite	10 Ton
Strok	241mm
İnik Haldeki Boyu	438mm
İnik Haldeki	52mm
Tırnak Boyu	
Taban Ölçüleri	152x222mm
Ağırlığı	18,00 Kg

RJ 1017

\$2.300,00

MEKANİK CIRCIRLI VAGON KRİKOSU



Kapasite	20 Ton
Strok	457mm
İnik Haldeki Boyu	717mm
İnik Haldeki	58mm
Tırnak Boyu	
Taban Ölçüleri	203x280mm
Ağırlığı	46,80 Kg

RJ 2029

\$2.976,00



BRITTORQUE



BRITTORQUE

MEKANİK TORK ANAHTARLARI

TW-224 / 324 / 424 / 624 / 824 SERİSİ

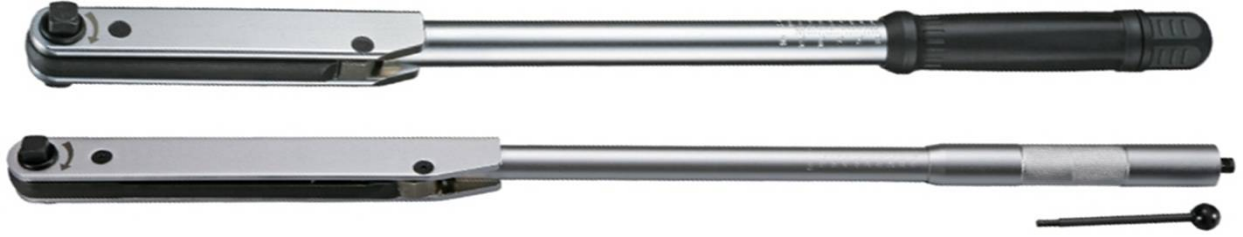

Soket	1/4"
Kapasitesi	2,5-11nm 0,3-1,12kgm
Boyu	338mm

TW-224-1S

\$93,50

Soket	3/8"
Kapasitesi	2,5-11nm 0,3-1,12kgm
Boyu	338mm

TW-324-1S

\$93,50

Soket	3/8"
Kapasitesi	5-33nm 0,5-3,4kgm
Boyu	425mm

TW-324-2S

\$93,50

Soket	1/2"
Kapasitesi	12-68nm 1,2-7kgm
Boyu	500mm

TW-424-1S

\$110,00

Soket	1/2"
Kapasitesi	25-135nm 3-13kgm
Boyu	556mm

TW-424-2S

\$117,00

Soket	1/2"
Kapasitesi	50-225nm 5-23kgm
Boyu	600mm

TW-424-3S

\$134,80

Soket	1/2"
Kapasitesi	70-330nm 7-35kgm
Boyu	805mm

TW-424-4S

\$147,20

Soket	3/4"
Kapasitesi	140-560nm 14-57kgm
Boyu	996mm

TW-624-1S

\$409,80

Soket	3/4"
Kapasitesi	200-800nm 22-82kgm
Boyu	1070mm

TW-624-2S

\$445,50

Soket	1"
Kapasitesi	200-1000nm 22-100kgm
Boyu	1400mm

TW-824-2S

\$583,00

MEKANİK CIRCIRLI TORK ANAHTARLARI

68867 SERİSİ



Soket	1"
Kapasitesi	200-800nm 22-82kgm
Boyu	1320mm

68867-2F

\$533,00

Soket	1"
Kapasitesi	300-1000nm 30-100kgm
Boyu	1320mm

68867-3F

\$600,00

MEKANİK CIRCIRLI TORK ANAHTARLARI

TW-822 SERİSİ



Soket	1"
Kapasitesi	400-2000nm 40-200kgm
Boyu	2300mm

TW-822-2FW

\$1.864,50

Soket	1"
Kapasitesi	500-2500nm 50-250kgm
Boyu	2755mm

TW-822-3FW

\$1.919,50

MEKANİK GEÇME KAFALI TORK ANAHTARLARI

TW-634 SERİSİ



Bağlantı çapı	Ø 16mm
Kapasitesi	20-100nm
Boy	500mm

TW-634-2F

\$120,00

MEKANİK TORK ANAHTARLARI TORNAVIDA TİPİ TW-262 SERİSİ



Bits uç ağzı	1/4"
Kapasitesi	0,39-1,64nm
Boy	0,04-0,17kgm

TW-262-12

\$121,00

Bits uç ağzı	1/4"
Kapasitesi	1-6nm
Boy	0,1-0,6kgm

TW-262-02

\$121,00

Bits uç ağzı	1/4"
Kapasitesi	4-9nm
Boy	0,4-0,9kgm

TW-262-03

\$121,00

TORK YÜKSELTİCİ



Soket Giriş-Çıkış	1/2"-1/2"
Tur Sayısı	3,4 : 1
Max.Çıkış Kap.	600nm/60kgm

TW-454-01

\$77,00



Soket Giriş-Çıkış	3/4"-1
Tur Sayısı	5 : 1
Max.Çıkış Kap.	2700nm/270kgm

TW-618

\$767,30

TORK AÇI ÖLÇER



Soket	1/2"
-------	------

TW-414

\$49,50

TORK KARELERİ



3/8"

\$16,50

1/2"

\$16,50

3/4"

\$29,00

1"

\$44,00



Soket Giriş-Çıkış	1/2"-1
Tur Sayısı	26 : 1
Max.Çıkış Kap.	4500nm/450kgm

TW-428-02

\$2.697,80



Cerim®



morrisflex



OVAL (STANDART DİŞLER)



SİVRİ BAŞ

		Düz	Talaş Kırıcılı
3mm	3x16mm Sertmetal	€ 8,00	
3mm	4x10mm Sertmetal	€ 11,90	
6mm	6x20mm Sertmetal	€ 16,30	€ 19,50
6mm	8x20mm Sertmetal	€ 16,50	€ 19,80
6mm	10x20mm Sertmetal	€ 20,50	€ 24,60
6mm	12x30mm Sertmetal	€ 24,20	€ 29,00
6mm	12x30mm Hss	€ 11,30	

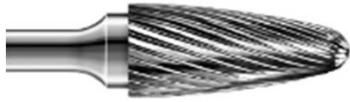

KÜT BAŞ

		Düz	Talaş Kırıcılı
3mm	3x16mm Sertmetal	€ 9,30	
3mm	4x12mm Sertmetal	€ 12,00	
3mm	6x16mm Sertmetal	€ 16,40	
6mm	6x20mm Sertmetal	€ 16,80	€ 20,10
6mm	8x20mm Sertmetal	€ 18,10	€ 21,60
6mm	10x20mm Sertmetal	€ 20,90	€ 25,00
6mm	12x25mm Sertmetal	€ 25,20	€ 30,30
6mm	15x30mm Sertmetal	€ 32,00	

6mm	6x18mm Sertmetal 150mm Sap	€ 25,00	
-----	-------------------------------	---------	--



KÜRE BAŞ

		Düz	Talaş Kırıcılı
3mm	3x16mm Sertmetal	€ 8,30	
3mm	4x8mm Sertmetal	€ 11,50	
6mm	8x18mm Sertmetal		€ 18,00
6mm	10x18mm Sertmetal	€ 19,00	€ 21,00
6mm	12x25mm Sertmetal	€ 24,00	€ 27,00
6mm	16x25mm Sertmetal	€ 34,00	€ 37,40

SİLİNDİRİK (STANDART DİŞLER)

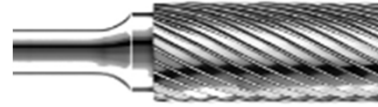

DÜZ BAŞ

		Düz	Talaş Kırıcılı
3mm	3x16mm Sertmetal	€ 6,30	
6mm	6x20mm Sertmetal	€ 12,90	€ 16,60
6mm	8x20mm Sertmetal	€ 16,40	€ 19,80
6mm	10x20mm Sertmetal	€ 18,60	€ 22,30
6mm	12x25mm Sertmetal	€ 24,10	€ 28,90
6mm	16x25 Sertmetal	€ 34,00	
6mm	30x30mm Ws	€ 10,00	

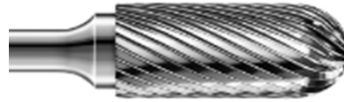

KÜRE BAŞ

		Düz	Talaş Kırıcılı
3mm	3x16mm Sertmetal	€ 7,90	€ 9,00
6mm	6x20mm Sertmetal	€ 14,50	€ 17,30
6mm	8x20mm Sertmetal	€ 18,50	€ 22,20
6mm	10x20mm Sertmetal	€ 21,40	€ 25,60
6mm	12x25mm Sertmetal	€ 29,00	€ 34,70
6mm	16x25 Sertmetal	€ 37,50	€ 46,30
6mm	6x20mm Hss	€ 6,90	
6mm	12x30mm Hss	€ 10,70	

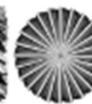

KESİCİ BAŞ

		Düz	Talaş Kırıcılı
3mm	3x16mm Sertmetal	€ 7,50	€ 8,00
6mm	6x20mm Sertmetal	€ 14,00	€ 15,00
6mm	8x20mm Sertmetal	€ 17,50	€ 19,50
6mm	10x20mm Sertmetal	€ 20,00	€ 22,00
6mm	12x25mm Sertmetal	€ 26,00	€ 28,00
6mm	12x30mm Hss	€ 12,50	
6mm	12x30mm Ws	€ 6,30	

ÇAM (STANDART DİŞLER)

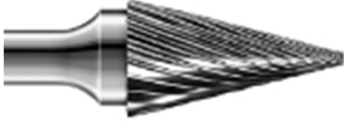

SİVRİ BAŞ

		Düz	Talaş Kırıcılı
3mm	3x14mm Sertmetal	€ 8,30	
3mm	4x11mm Sertmetal	€ 10,00	
3mm	6x14mm Sertmetal	€ 11,00	€ 14,50
6mm	6x20mm Sertmetal	€ 13,60	€ 16,30
6mm	8x18mm Sertmetal	€ 12,80	€ 15,30
6mm	10x20mm Sertmetal	€ 15,30	€ 18,30
6mm	12x25mm Sertmetal	€ 20,80	€ 24,90
6mm	6x20mm Hss	€ 8,80	
6mm	10x18mm Hss	€ 9,40	
6mm	12x30mm Hss	€ 12,30	



KÜT BAŞ

		Düz	Talaş Kırıcılı
3mm	3x16mm Sertmetal	€ 8,30	
3mm	4x16mm Sertmetal	€ 11,30	
6mm	6x20mm Sertmetal	€ 14,50	
6mm	8x25mm Sertmetal	€ 20,50	€ 22,00
6mm	10x25mm Sertmetal	€ 25,40	€ 27,50
6mm	12x32mm Sertmetal	€ 30,40	€ 36,40
3mm	7x10mm Hss	€ 7,00	
6mm	10x15mm Hss	€ 10,00	
6mm	15x35mm Hss	€ 17,50	

KÜRE (STANDART DİŞLER)



		Düz
3mm	2mm Sertmetal	€ 9,80
3mm	3mm Sertmetal	€ 8,30
3mm	4mm Sertmetal	€ 10,20
3mm	5mm Sertmetal	€ 10,20
6mm	4mm Sertmetal	€ 14,90
6mm	6mm Sertmetal	€ 14,90
6mm	8mm Sertmetal	€ 14,10
6mm	10mm Sertmetal	€ 16,60
6mm	12mm Sertmetal	€ 20,00
6mm	16mm Sertmetal	€ 27,50
6mm	8mm Hss	€ 12,50
6mm	10mm Hss	€ 12,50
6mm	15mm Hss	€ 15,00

TRAPEZ (STANDART DİŞLER)



		Düz
6mm	2x3x3mm Hss	€ 7,00
6mm	8x12x30mm Hss	€ 11,00
6mm	20x30x30mm Ws	€ 12,00



		Düz
6mm	3x1mm Hss	€ 7,00

ÇAM (ALÜMİNYUM DİŞLER)



KÜRE BAŞ

		Alüminyum
6mm	8x25mm Sertmetal	€ 22,00
6mm	12x32mm Sertmetal	€ 36,40

SİLİNDİRİK (ALÜMİNYUM DİŞLER)



KÜT BAŞ

		Alüminyum
6mm	8x20mm Sertmetal	€ 22,20
6mm	12x25mm Sertmetal	€ 34,70
6mm	16x25 Sertmetal	€ 46,30

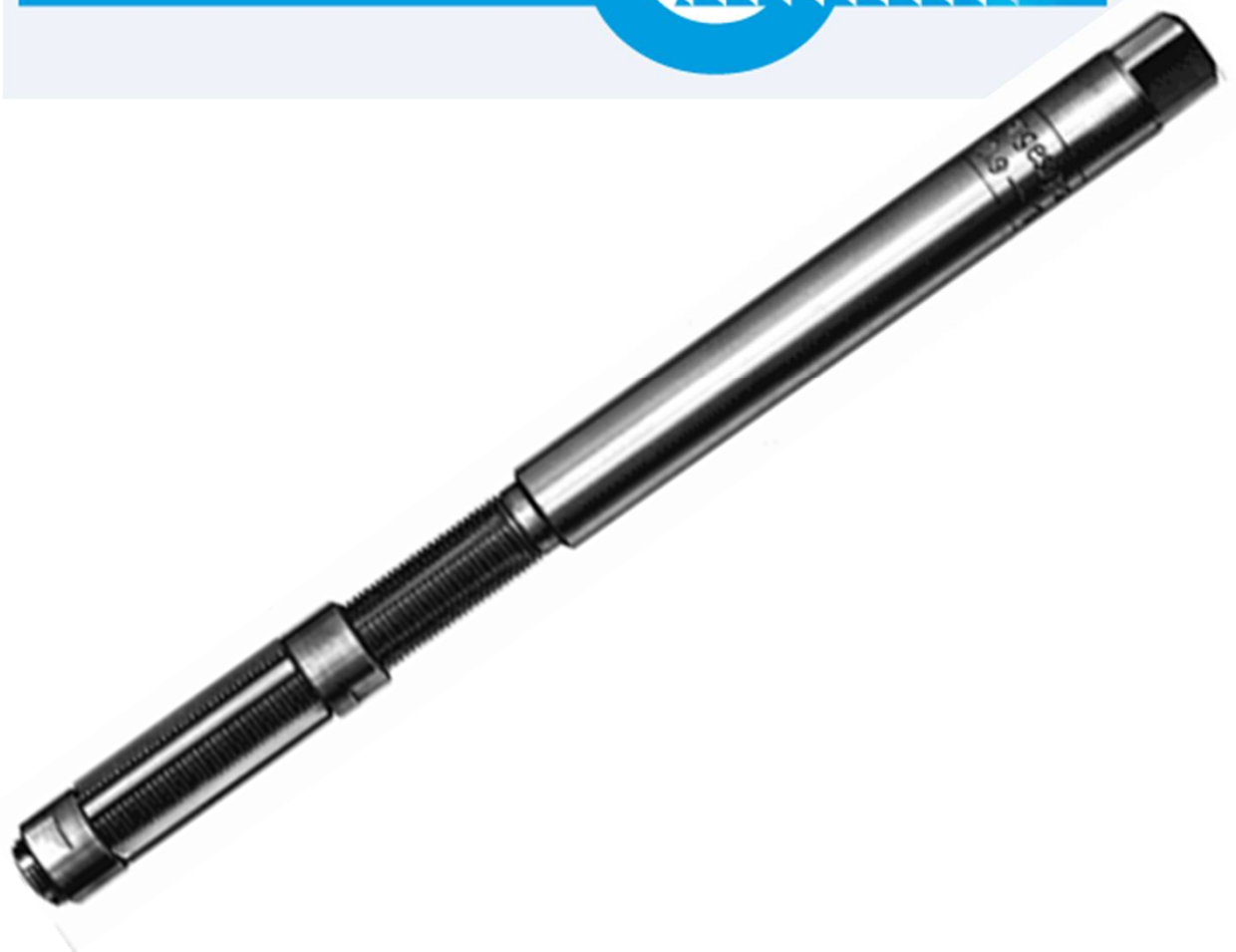

AYARLI RAYBALAR



Ölçü	D / KOVANSIZ		K / KOVANLI	
	Boy Bıçak Ad Bıçak Boy	Tek	Boy Bıçak Ad Bıçak Boy	Tek
7,2-8 9/32-5/16	111mm 4 / 32mm	€ 84,20		
8-9 5/16-23/64	111mm 5 / 32mm	€ 84,20	175mm 5 / 32mm	€ 123,90
9-10 23/64-25/64	115mm 5 / 32mm	€ 81,80	175mm 5 / 32mm	€ 123,90
10-11 25/64-7/16	120mm 5 / 35mm	€ 81,80	185mm 5 / 35mm	€ 128,70
11-12 7/16-15/32	125mm 5 / 35mm	€ 81,80	195mm 5 / 35mm	€ 129,90
12-13,5 15/32-17/32	130mm 5 / 42mm	€ 81,80	215mm 5 / 42mm	€ 134,70
13,5-15,5 17/32-39/64	145mm 5 / 50mm	€ 90,20	235mm 5 / 50mm	€ 137,20
15,5-18 39/64-45/64	165mm 5 / 60mm	€ 102,30	265mm 5 / 60mm	€ 143,20
18-21 45/64-53/64	180mm 5 / 65mm	€ 110,70	290mm 5 / 65mm	€ 157,60
21-24 53/64-15/16	190mm 5 / 70mm	€ 117,80	310mm 5 / 70mm	€ 175,60
24-27,5 15/16-1,5/64	205mm 5 / 75mm	€ 133,50	335mm 5 / 75mm	€ 202,10
27,5-31,5 1,5/64-1,15/64	225mm 6 / 80mm	€ 162,40	365mm 6 / 80mm	€ 235,80
31,5-37 1,15/64-1,29/64	240mm 6 / 90mm	€ 218,90	400mm 6 / 90mm	€ 328,40
37-45 1,29/64-1,49/64	285mm 6 / 100mm	€ 299,50	465mm 6 / 100mm	€ 455,90
45-55 1,49/64-2,5/32	320mm 6 / 109mm	€ 409,00	530mm 6 / 109mm	€ 605,00
55-65 2,5/32-2,9/16	350mm 8 / 120mm	€ 571,30	570mm 8 / 120mm	€ 822,70
65-80 2,9/16-3,5/32	460mm 10 / 145mm	€ 989,90	670mm 10 / 145mm	€ 1.326,60
80-95 3,5/32-3,47/64	490mm 10 / 150mm	€ 1.356,70	700mm 10 / 150mm	€ 1.843,80
95-110 3,47/64-4,21/64	490mm 10 / 150mm	€ 1.632,10	700mm 10 / 150mm	€ 2.336,90

Ölçü	Takım		Takım	
8-31,5 5/16-1,15/64	11 parça	€ 1.210,00	11 parça	€ 1.840,20
8-45 5/16-1,49/64	13 parça	€ 1.762,00	13 parça	€ 2.680,90

AYARLI SUBAP RAYBALARI



Ölçü	V / SUBAP	
	Boy Bıçak Ad Bıçak Boy	Tek
5,4-6 7/32-15/64	160mm 3 / 28mm	€ 96,30
5,9-6,5 15/64-1/4	160mm 3 / 28mm	€ 96,30
6,4-7 1/4-17/64	160mm 3 / 28mm	€ 96,30
6,9-7,5 17/64-19/64	160mm 3 / 28mm	€ 96,30
7,4-8 19/64-5/16	165mm 3 / 28mm	€ 96,30
7,9-8,5 5/16-21/64	170mm 3 / 28mm	€ 96,30
8,4-9 21/64-23/64	175mm 3 / 28mm	€ 96,30
8,9-9,5 23/64-3/8	180mm 4 / 32mm	€ 98,70
9,4-10 3/8-25/64	190mm 4 / 32mm	€ 98,70
9,9-11 25/64-7/16	200mm 5 / 36mm	€ 103,50
10,9-12 7/16-15/32	220mm 5 / 36mm	€ 105,90

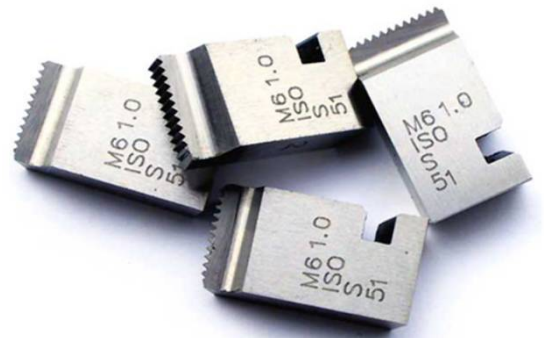

OSG
NAMCO
NEBSON
WMW

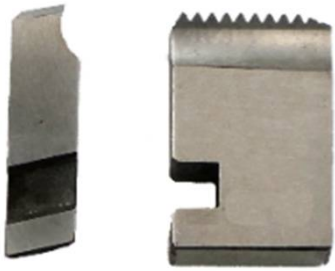

OSG

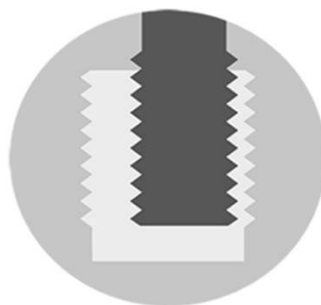

OTOMATİK PAFTA KAFA VE TARAKLARI

COVENTRY TİPİ OTOMATİK PAFTA KAFA VE TARAKLARI

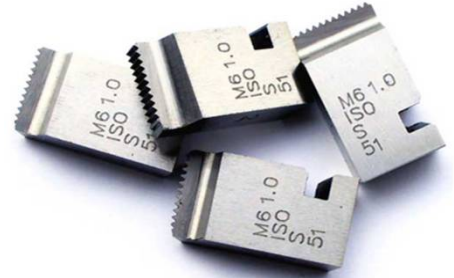

OSG JAPONYA	NEBSON İNGİLTERE WMW ALMANYA	KAFA ÖLÇÜSÜ	OSG-JAPONYA WMW-ALMANYA			NAMCO-İNGİLTERE NEBSON-İNGİLTERE		
			DİŞ			MM - BSW UNF - UNC	GAS	NPT - SOL
€ 1.357,00		8 / H-1 2-8mm	€ 95,70	€ 113,30	€ 143,00			
€ 1.357,00	€ 950,00	13 / H-2 3-13mm	€ 95,70	€ 113,30	€ 143,00			
€ 1.652,00	€ 1.150,00	19 / H-3 6-19mm	€ 122,10	€ 149,60	€ 185,90			
€ 2.149,00	€ 1.500,00	25 / H-4 6-25mm	€ 143,00	€ 172,70	€ 213,40			
€ 3.114,00	€ 2.300,00	32 / H-5 10-32mm	€ 267,30	€ 321,20	€ 399,30			

OSG

3 AĞIZ KISA TİP HSS-Co PARMAK FREZE



ETS-3 DIN 327 HSS-E %8 Co.	5mm 52x8mm	€ 14,00
	6mm 52x8mm	€ 14,00

4 AĞIZ KISA TİP HSS-Co PARMAK FREZE

EMS-4
DIN 844
HSS-E
%8 Co.



2,5mm 52x8mm	€ 14,00
3mm 52x8mm	€ 14,00
3,5mm 54x10mm	€ 14,00
4mm 55x11mm	€ 14,00
5mm 57x13mm	€ 14,00
6mm 57x13mm	€ 14,00
8mm 69x19mm	€ 15,00
20mm 104x38mm	€ 38,50
22mm 104x38mm	€ 52,50
26mm 121x45mm	€ 77,00
28mm 121x45mm	€ 83,00

4 AĞIZ UZUN TİP HSS-Co PARMAK FREZE

EML-4
DIN 844
HSS-E
%8 Co.



5mm 68x24mm	€ 16,00
6mm 68x24mm	€ 17,00
10mm 95x45mm	€ 22,50
12mm 110x53mm	€ 26,50
14mm 110x53mm	€ 30,00
16mm 123x63mm	€ 36,50
24mm 166x90mm	€ 92,50
26mm 166x90mm	€ 108,00
28mm 166x90mm	€ 117,00
30mm 166x90mm	€ 140,50



A-AUST



A-AUST

TEK TAŞ TAŞ DÜZELTME ELMASLARI



0,30 carat 14 x 64mm	€ 17,30
0,40 carat 14 x 64mm	€ 21,90
0,50 carat 14 x 64mm	€ 25,30
0,70 carat 14 x 64mm	€ 38,00
0,75 carat 14 x 64mm	€ 41,40
1,00 carat 14 x 64mm	€ 52,90
1,50 carat 14 x 64mm	€ 79,40
2,00 carat 14 x 64mm	€ 110,40
2,50 carat 14 x 64mm	€ 153,00
3,00 carat 14 x 64mm	€ 196,70
4,00 carat 14 x 64mm	€ 276,00
5,00 carat 14 x 64mm	€ 333,50

A Kalite	1,00 carat 103 / 9x31,5mm	€ 273,70
A Kalite	1,00 carat 104 / 16x42mm	€ 273,70
A Kalite	1,00 carat 110 / 9x25mm	€ 273,70

ELMAS TAŞ DÜZELTME PLAKALAR



K Tipi



S Tipi

PA-115S 33x23x5mm	€ 271,40
PA-115K 33x20,5x5mm	€ 208,80
PB-115K 33x10,5x5mm	€ 139,20
PC-115K 28x20,5x5mm	€ 174,30
PD-115S 28x13x5mm	€ 163,30
PD-115K 28x10,5x5mm	€ 125,40

SAPLI ELMAS TAŞ DÜZELTME PLAKALAR



PB-180K € 139,20

ÇOK TAŞLI TAŞ DÜZELTME ELMASLARI



1,00 carat V60 taşlı 12,5x53mm	€ 135,70
1,00 carat V60 taşlı 18x58mm	€ 135,70
2,50 carat V60 taşlı 12,5x53mm	€ 145,50

ÇOK TAŞLI DAİRESEL TAŞ DÜZELTME ELMASLARI



402

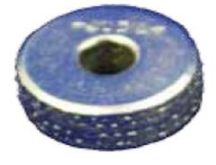

405



0,75 carat 402 / 50 taşlı 15x5x6mm	€ 253,00
2,00 carat 405 / 160 taşlı 20x8x6mm	€ 487,10
SAP	€ 21,90

A-AUST

SAPLI TAŞ DÜZELTMELER

HA-S



HA-G

3,00 carat HA-G / 25x8mm	€ 189,80
3,00 carat HA-S / 25x8mm	€ 189,80

PROFİL ELMASLARI



201 40 / 0,125	€ 300,20
201 40 / 0,250	€ 300,20
201 40 / 0,500	€ 300,20
201 60 / 0,250	€ 300,20
201 60 / 0,500	€ 300,20
204 Fortuna	€ 300,20

SERTLİK ÖLÇMELER

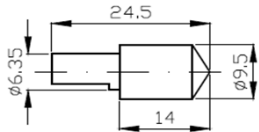

511

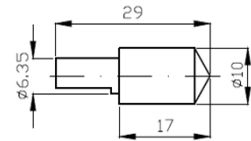

512

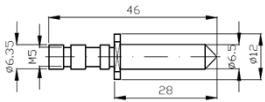

513

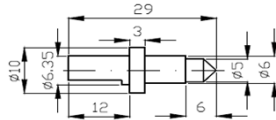

514

511 Rockwell 120 derece	€ 291,00
512 Rockwell 120 derece	€ 291,00
513 Rockwell 120 derece	€ 310,00
514 Rockwell 120 derece	€ 310,00

ELMAS PASTALAR



1 My 10gr	€ 111,60
3 My 10gr	€ 138,00
7 My 10gr	€ 164,50
15 My 10gr	€ 164,50
30 My 10gr	€ 190,90
45 My 10gr	€ 264,50
90 My 10gr	€ 264,50

ELMAS CAM MATKAPLARI



5mm 75mm	€ 97,80
8mm 75mm	€ 105,80
10mm 75mm	€ 120,20
12mm 75mm	€ 130,60
16mm 75mm	€ 147,80
20mm 75mm	€ 167,40
24mm 75mm	€ 185,20
26mm 75mm	€ 197,80
34mm 70mm	€ 260,50
42mm 70mm	€ 323,20
49mm 70mm	€ 369,20

7/8x14 UNF
Diş

ELMAS EĞELER



Lama 160mm	€ 18,40
Kare 160mm	€ 18,40
Üçken 160mm	€ 18,40
Yuvarlak 160mm	€ 18,40
Yarım Yuvarlak 160mm	€ 18,40



ALPHA



SERTMETAL FREZE UCU

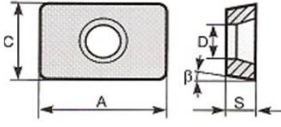

ADKA 1503..	
A=15 C=9,52 D=4,4 S=3,18	
Normal	€ 3,60
Kaplamalı	€ 4,60
Çok kapl.	€ 4,90

SERTMETAL FREZE UCU

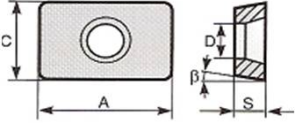

APKA 1504..	
A=15 C=9,52 D=4,4 S=3,18	
Normal	€ 4,60
Kaplamalı	€ 5,80
Çok kapl.	€ 6,20

APKA 2204..	
A=20 C=12,7 D=5,4 S=4,76	
Normal	€ 4,70
Kaplamalı	€ 6,00
Çok kapl.	€ 6,50

SERTMETAL TORNA UCU

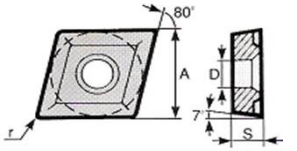

CCMT-09.T..	
A=9,52 D=4,4 S=3,97	
Normal	€ 3,10
Kaplamalı	€ 3,40
Çok kapl.	€ 3,70

SERTMETAL TORNA UCU

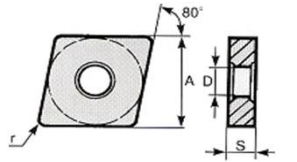

CNMA-1204..	
A=12,7 D=5,16 S=4,76	
Normal	€ 4,00
Kaplamalı	€ 4,90
Çok kapl.	€ 5,10

SERTMETAL TORNA UCU

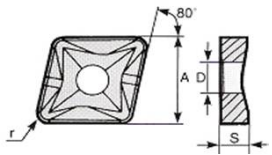

CNMM-1204..	
A=12,7 D=5,16 S=4,76	
Normal	€ 2,80
Kaplamalı	€ 3,10
Çok kapl.	€ 3,30

CNMM-1906..	
A=19,05 D=7,93 S=6,35	
Normal	€ 7,70
Kaplamalı	€ 8,60
Çok kapl.	€ 9,00

CNMM-1606..	
A=15,88 D=6,35 S=6,35	
Normal	€ 5,20
Kaplamalı	€ 5,80
Çok kapl.	€ 6,60

SERTMETAL TORNA UCU

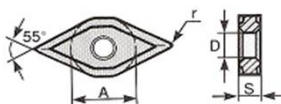

DNMG-1506..	
A=12,7 D=5,16 S=6,35	
Normal	€ 4,10
Kaplamalı	€ 5,40
Çok kapl.	€ 5,60

DNMG-1906..	
A=15,88 D=6,35 S=6,35	
Normal	€ 6,90
Kaplamalı	€ 8,50
Çok kapl.	€ 9,10

SERTMETAL TORNA UCU

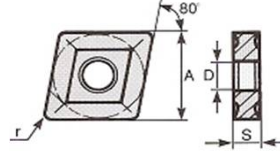

CNMG-1204..	
A=12,7 D=5,16 S=4,76	
Normal	€ 2,80
Kaplamalı	€ 3,10
Çok kapl.	€ 3,30

CNMG-1606..	
A=15,88 D=6,35 S=6,35	
Normal	€ 5,20
Kaplamalı	€ 5,80
Çok kapl.	€ 6,60

CNMG-2509	
A=25,4 D=9,12 S=9,52	
Normal	€ 18,90
Kaplamalı	€ 20,90
Çok kapl.	€ 23,10

CNMG-1906	
A=19,05 D=7,93 S=6,35	
Normal	€ 7,70
Kaplamalı	€ 8,60
Çok kapl.	€ 9,00

SERTMETAL TORNA UCU

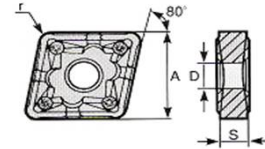

CNMX-1906..	
A=19,05 D=7,93 S=6,35	
Normal	€ 8,50
Kaplamalı	€ 9,40
Çok kapl.	€ 9,90

SERTMETAL TORNA UCU

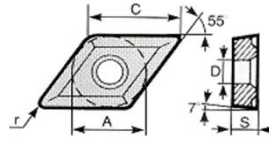

DCMT-11.T..	
A=9,52 C=11,6 D=4,4 S=3,97	
Normal	€ 2,70
Kaplamalı	€ 3,00
Çok kapl.	€ 3,20

SERTMETAL TORNA UCU

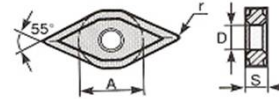

DNMA-1506..	
A=12,7 D=5,16 S=6,35	
Normal	€ 3,70
Kaplamalı	€ 4,10
Çok kapl.	€ 4,80

SERTMETAL TORNA UCU

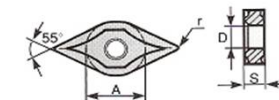

DNMM-1506..	
A=12,7 D=5,16 S=6,35	
Normal	€ 4,50
Kaplamalı	€ 5,00
Çok kapl.	€ 5,90

SERTMETAL TORNA UCU

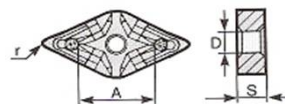

DNMX-1506..	
A=12,7 D=5,16 S=6,35	
Normal	€ 4,50
Kaplamalı	€ 5,00
Çok kapl.	€ 5,30

SERTMETAL TORNA UCU

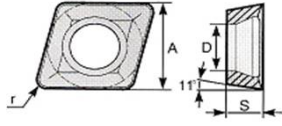

EPMM-0803..	
A=8 D=4,4 S=3	
Normal	€ 3,00
Kaplamalı	€ 3,90
Çok kapl.	€ 4,20

SERTMETAL FREZE UCU

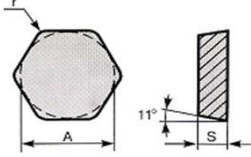

HPUN-0804	
A=14 S=4,76	
Normal	€ 5,40
Kaplamalı	€ 7,10
Çok kapl.	€ 7,60

SERTMETAL TORNA UCU

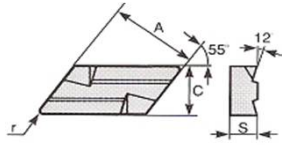

KNUX-1604..	
A=16,15 C=9,52 S=4,76	
Normal	€ 2,90
Kaplamalı	€ 3,70
Çok kapl.	€ 3,90

SERTMETAL FREZE UCU

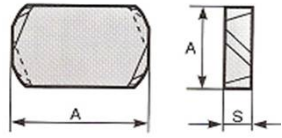

LNJN-2204..	
A=12,7 C=22 S=5	
Normal	€ 8,20
Kaplamalı	€ 9,80
Çok kapl.	€ 10,60

SERTMETAL FREZE UCU

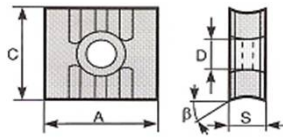

LNKN-1205..	
A=12,7 C=11,5 D=4,4 S=5,2	
Normal	€ 8,40
Kaplamalı	€ 10,70
Çok kapl.	€ 11,60

SERTMETAL TORNA UCU

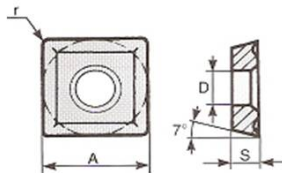

SCMM-0904..	
A=9,52 D=4,4 S=4	
Normal	€ 2,70
Kaplamalı	€ 2,90
Çok kapl.	€ 3,20

SCMM-1205..	
A=12,7 D=5,4 S=5	
Normal	€ 4,20
Kaplamalı	€ 4,60
Çok kapl.	€ 4,90

SERTMETAL FREZE UCU

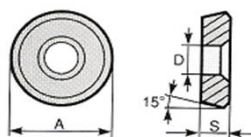

RDEA-10.T	
A=10 D=4,4 S=3,97	
Normal	€ 4,10
Kaplamalı	€ 5,70
Çok kapl.	€ 6,10

SERTMETAL TORNA UCU

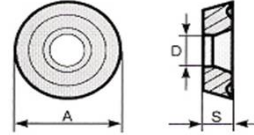

RCMX-1003	
A=10 D=3,6 S=3,18	
Normal	€ 2,50
Kaplamalı	€ 3,30
Çok kapl.	€ 3,60

RCMX-2507	
A=25 D=7,2 S=7,94	
Normal	€ 16,10
Kaplamalı	€ 19,60
Çok kapl.	€ 20,60

RCMX-1204	
A=12 D=4,2 S=4,76	
Normal	€ 3,80
Kaplamalı	€ 4,80
Çok kapl.	€ 5,00

RCMX-3209	
A=32 D=9,5 S=9,52	
Normal	€ 24,80
Kaplamalı	€ 28,80
Çok kapl.	€ 30,30

RCMX-2006	
A=20 D=6,5 S=6,35	
Normal	€ 7,40
Kaplamalı	€ 9,20
Çok kapl.	€ 9,70

SERTMETAL TORNA UCU

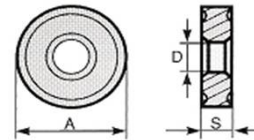

RNMG-0903	
A=9,52 D=3,81 S=3,18	
Normal	€ 2,20
Kaplamalı	€ 3,00
Çok kapl.	€ 3,20

RNMG-1906	
A=19,05 D=7,93 S=6,35	
Normal	€ 6,90
Kaplamalı	€ 8,50
Çok kapl.	€ 9,10

SERTMETAL FREZE UCU

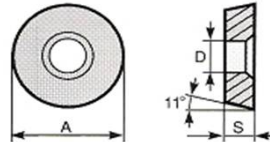

RPEA-1204	
A=12 D=4,4 S=4,76	
Normal	€ 4,30
Kaplamalı	€ 6,00
Çok kapl.	€ 6,50

SERTMETAL TORNA UCU

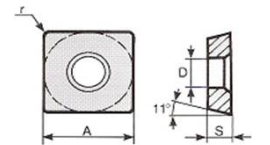

SCMA-1205..	
A=12,7 D=5,4 S=5	
Normal	€ 4,20
Kaplamalı	€ 4,60
Çok kapl.	€ 4,90

SERTMETAL FREZE UCU

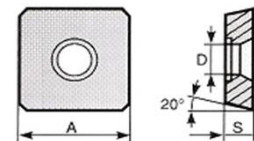

SEHX-1204..	
A=12,7 D=5,4 S=4,76	
Normal	€ 3,90
Kaplamalı	€ 5,10
Çok kapl.	€ 5,40

SEHX-1504..	
A=15,88 D=5,4 S=4,76	
Normal	€ 5,80
Kaplamalı	€ 7,30
Çok kapl.	€ 8,00

SERTMETAL FREZE UCU

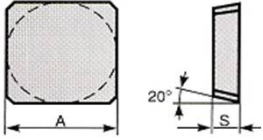

SDKN-1203..	
A=12,7 S=3,18	
Normal	€ 3,90
Kaplamalı	€ 5,10
Çok kapl.	€ 5,40

SERTMETAL FREZE UCU

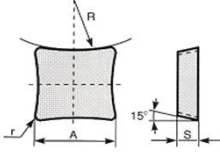

SDUX-1906..	
A=19 S=4,76	
Normal	€ 6,90
Kaplamalı	€ 8,50
Çok kapl.	€ 9,10

SERTMETAL FREZE UCU

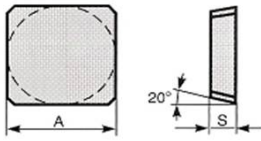

SECN-1203..	
A=12,7 S=3,18	
Normal	€ 4,60
Kaplamalı	€ 5,80
Çok kapl.	€ 6,20

SERTMETAL FREZE UCU

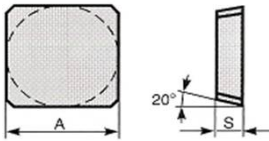

SEGN-0903..	
A=9,52 D=4,4 S=3,18	
Normal	€ 3,90
Kaplamalı	€ 5,10
Çok kapl.	€ 5,40

SERTMETAL FREZE UCU

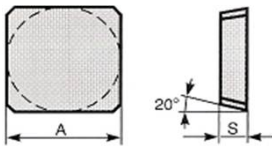

SEKN-1203..	
A=12,7 S=3,18	
Normal	€ 3,80
Kaplamalı	€ 4,90
Çok kapl.	€ 5,20

SEKN-1504..	
A=15,88 S=4,76	
Normal	€ 5,70
Kaplamalı	€ 7,20
Çok kapl.	€ 7,90

SERTMETAL FREZE UCU

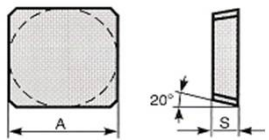

SEKR-1203..	
A=12,7 S=3,18	
Normal	€ 3,80
Kaplamalı	€ 4,90
Çok kapl.	€ 5,20

SERTMETAL FREZE UCU

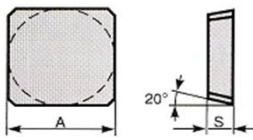

SFAN-1203	
A=12,7 S=3,18	
Normal	€ 6,90
Kaplamalı	€ 8,60
Çok kapl.	€ 9,10

SERTMETAL FREZE UCU

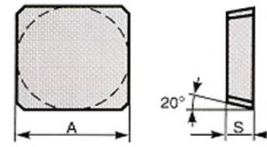

SEMN-1203..	
A=12,7 S=3,18	
Normal	€ 3,80
Kaplamalı	€ 4,90
Çok kapl.	€ 5,20

SEMN-1204..	
A=12,7 S=4,76	
Normal	€ 4,70
Kaplamalı	€ 6,10
Çok kapl.	€ 6,60

SERTMETAL TORNA UCU

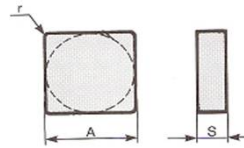

SNGN-1204..	
A=12,7 S=4,76	
Normal	€ 5,70
Kaplamalı	€ 6,40
Çok kapl.	€ 6,40

SERTMETAL FREZE UCU

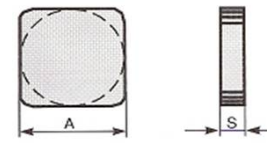

SNKN-1204..	
A=12,7 S=4,76	
Normal	€ 5,90
Kaplamalı	€ 7,60
Çok kapl.	€ 8,20

SNKN-1504..	
A=15,88 S=4,76	
Normal	€ 5,70
Kaplamalı	€ 7,20
Çok kapl.	€ 7,90

SERTMETAL TORNA UCU

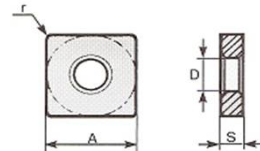

SNMA-1204..	
A=12,7 D=5,16 S=4,76	
Normal	€ 3,50
Kaplamalı	€ 4,30
Çok kapl.	€ 4,60

SNMA-2509..	
A=25,4 D=9,12 S=9,52	
Normal	€ 18,40
Kaplamalı	€ 22,50
Çok kapl.	€ 23,60

SNMA-1906..	
A=19,05 D=7,93 S=6,35	
Normal	€ 7,50
Kaplamalı	€ 9,00
Çok kapl.	€ 10,20

SERTMETAL TORNA UCU

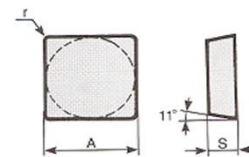

SPGN-1203..	
A=12,7 S=3,18	
Normal	€ 5,90
Kaplamalı	€ 7,00
Çok kapl.	€ 7,50

SPGN-1204..	
A=12,7 S=4,76	
Normal	€ 7,70
Kaplamalı	€ 9,30
Çok kapl.	€ 10,10

SERTMETAL TORNA UCU

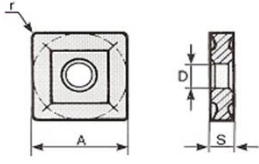

SNMG-0903..	
A=9,52 D=3,81 S=3,18	
Normal	€ 2,20
Kaplamalı	€ 3,00
Çok kapl.	€ 3,20

SNMG-1204..	
A=12,7 D=5,16 S=4,76	
Normal	€ 3,20
Kaplamalı	€ 3,50
Çok kapl.	€ 3,60

SNMG-2509..	
A=25,4 D=9,12 S=9,52	
Normal	€ 18,20
Kaplamalı	€ 25,60
Çok kapl.	€ 27,50

SNMG-2507..	
A=25,4 D=9,12 S=7,94	
Normal	€ 18,20
Kaplamalı	€ 21,70
Çok kapl.	€ 23,50

SERTMETAL TORNA UCU

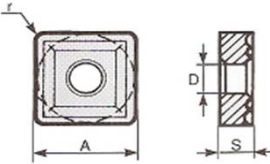

SNMM-1204..	
A=12,7 D=5,16 S=4,76	
Normal	€ 3,80
Kaplamalı	€ 4,90
Çok kapl.	€ 5,10

SNMM-1906	
A=19,05 D=7,93 S=6,35	
Normal	€ 8,70
Kaplamalı	€ 10,60
Çok kapl.	€ 11,00

SNMM-2509..	
A=25,4 D=9,12 S=9,52	
Normal	€ 22,50
Kaplamalı	€ 29,00
Çok kapl.	€ 31,30

SNMM-2507..	
A=25,4 D=9,12 S=7,94	
Normal	€ 19,10
Kaplamalı	€ 20,80
Çok kapl.	€ 21,90

SERTMETAL TORNA UCU

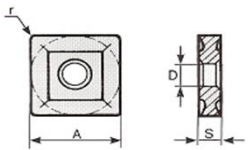

SNMX-1204..	
A=12,7 D=5,16 S=4,76	
Normal	€ 3,80
Kaplamalı	€ 4,90
Çok kapl.	€ 5,10

SERTMETAL TORNA UCU

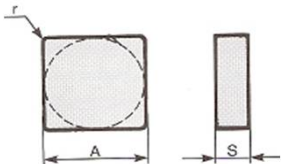

SNUN-1203..	
A=12,7 S=3,18	
Normal	€ 2,90
Kaplamalı	€ 3,80
Çok kapl.	€ 4,10

SNUN-1204..	
A=12,7 S=4,76	
Normal	€ 3,80
Kaplamalı	€ 4,80
Çok kapl.	€ 5,00

SNUN-1904..	
A=19,05 S=4,76	
Normal	€ 6,90
Kaplamalı	€ 8,60
Çok kapl.	€ 9,10

SNUN-1504..	
A=15,87 S=4,76	
Normal	€ 5,00
Kaplamalı	€ 6,40
Çok kapl.	€ 7,00

SERTMETAL FREZE UCU

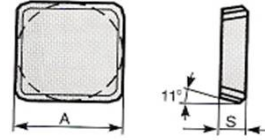

SPAN-1203..	
A=12,7 S=3,18	
Normal	€ 6,90
Kaplamalı	€ 8,60
Çok kapl.	€ 9,10

SERTMETAL FREZE UCU

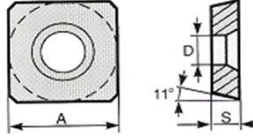

SPKA-1204..	
A=12,7 D=5,4 S=4,76	
Normal	€ 4,80
Kaplamalı	€ 6,20
Çok kapl.	€ 6,60

SERTMETAL FREZE UCU

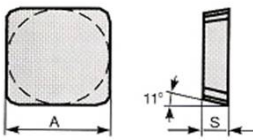

SPKN-1203..	
A=12,7 S=3,18	
Normal	€ 3,00
Kaplamalı	€ 3,80
Çok kapl.	€ 4,20

SPKN-1504..	
A=15,87 S=4,76	
Normal	€ 4,40
Kaplamalı	€ 5,60
Çok kapl.	€ 6,30

SERTMETAL FREZE UCU

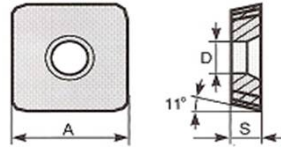

SPKX-1204..	
A=12,7 D=5,4 S=4,76	
Normal	€ 4,90
Kaplamalı	€ 6,30
Çok kapl.	€ 6,90

SERTMETAL FREZE UCU

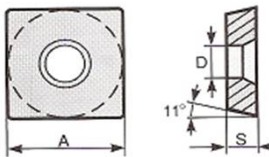

SPMA-0903..	
A=9,52 D=4,4 S=3,18	
Normal	€ 2,90
Kaplamalı	€ 3,70
Çok kapl.	€ 4,00

SPMA-1204..	
A=12,7 D=5,4 S=4,76	
Normal	€ 4,20
Kaplamalı	€ 5,40
Çok kapl.	€ 5,90

SERTMETAL TORNA UCU

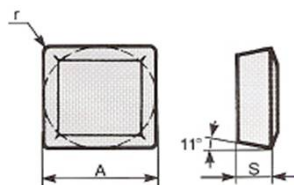

SPMR-0903..	
A=9,52 S=3,18	
Normal	€ 2,40
Kaplamalı	€ 2,60
Çok kapl.	€ 2,70

SPMR-1203..	
A=12,7 S=3,18	
Normal	€ 3,00
Kaplamalı	€ 3,30
Çok kapl.	€ 3,40

SERTMETAL TORNA UCU

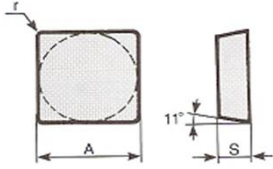

SPUN-0903..	
A=9,52 S=3,18	
Normal	€ 2,20
Kaplamalı	€ 2,40
Çok kapl.	€ 2,50

SPUN-1504..	
A=15,87 S=4,76	
Normal	€ 5,00
Kaplamalı	€ 6,50
Çok kapl.	€ 7,00

SPUN-1203..	
A=12,7 S=3,18	
Normal	€ 2,70
Kaplamalı	€ 3,00
Çok kapl.	€ 3,20

SPUN-1904..	
A=19,05 S=4,76	
Normal	€ 6,90
Kaplamalı	€ 8,60
Çok kapl.	€ 9,10

SPUN-1204..	
A=12,7 S=4,76	
Normal	€ 3,60
Kaplamalı	€ 4,60
Çok kapl.	€ 4,80

SERTMETAL TORNA UCU

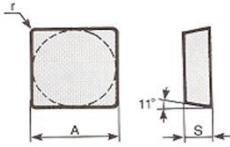

SPUX-1203..	
A=12,7 S=3,18	
Normal	€ 3,60
Kaplamalı	€ 4,60
Çok kapl.	€ 4,70

SERTMETAL TORNA UCU

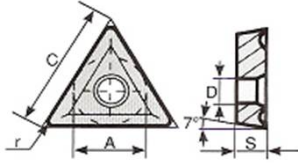

TCMA-2205	
A=12,7 C=22 D=5,4 S=4,76	
Normal	€ 5,90
Kaplamalı	€ 7,20
Çok kapl.	€ 7,60

SERTMETAL TORNA UCU

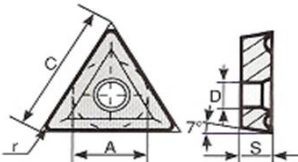

TCMM-1604..	
A=9,52 C=16,5 D=4,4 S=4	
Normal	€ 3,00
Kaplamalı	€ 3,30
Çok kapl.	€ 3,60

TCMM-2205..	
A=12,7 C=22 D=5,4 S=4,76	
Normal	€ 5,90
Kaplamalı	€ 7,20
Çok kapl.	€ 7,60

SERTMETAL FREZE UCU

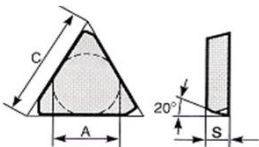

TEKN-2204..	
A=12,7 C=22 S=4,76	
Normal	€ 8,20
Kaplamalı	€ 9,90
Çok kapl.	€ 10,60

SERTMETAL TORNA UCU

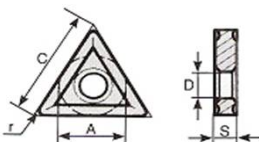

TNMB-1603	
A=9,52 C=16,5 D=3,81 S=3,18	
Normal	€ 2,20
Kaplamalı	€ 3,10
Çok kapl.	€ 3,20

SERTMETAL TORNA UCU

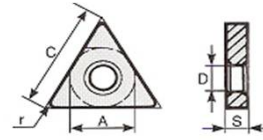

TNMA-1603	
A=9,52 C=16,5 D=3,81 S=3,18	
Normal	€ 2,20
Kaplamalı	€ 3,10
Çok kapl.	€ 3,20

TNMA-2204..	
A=15,87 C=22 D=5,16 S=4,76	
Normal	€ 3,80
Kaplamalı	€ 5,00
Çok kapl.	€ 5,30

TNMA-1604..	
A=9,52 C=16,5 D=3,81 S=4,76	
Normal	€ 2,90
Kaplamalı	€ 3,80
Çok kapl.	€ 4,00

SERTMETAL TORNA UCU

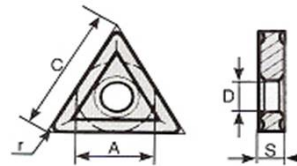

TNMG-1603..	
A=9,52 C=16,5 D=3,81 S=3,18	
Normal	€ 2,80
Kaplamalı	€ 3,20
Çok kapl.	€ 3,40

TNMG-1604..	
A=9,52 C=16,5 D=3,81 S=4,76	
Normal	€ 3,10
Kaplamalı	€ 4,00
Çok kapl.	€ 4,20

TNMG-2706	
A=15,87 C=27,5 D=6,35 S=6,35	
Normal	€ 7,40
Kaplamalı	€ 9,60
Çok kapl.	€ 10,10

TNMG-2204..	
A=12,7 C=22 D=5,16 S=4,76	
Normal	€ 3,80
Kaplamalı	€ 4,20
Çok kapl.	€ 4,40

SERTMETAL TORNA UCU



TNMM-1604..	
A=9,52 C=16,5 D=3,81 S=4,76	
Normal	€ 3,10
Kaplamalı	€ 4,00
Çok kapl.	€ 4,20

TNMM-2706..	
A=15,87 C=27,5 D=6,35 S=6,35	
Normal	€ 7,40
Kaplamalı	€ 9,60
Çok kapl.	€ 10,20

TNMM-2204..	
A=12,7 C=22 D=5,16 S=4,76	
Normal	€ 4,10
Kaplamalı	€ 5,20
Çok kapl.	€ 5,50

SERTMETAL TORNA UCU

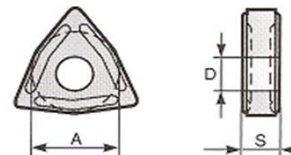

TNMX-1604..	
A=9,52 C=16,5 D=3,81 S=4,76	
Normal	€ 3,10
Kaplamalı	€ 4,00
Çok kapl.	€ 4,30

TNMX-2204..	
A=12,7 C=22 D=5,16 S=4,76	
Normal	€ 4,20
Kaplamalı	€ 5,40
Çok kapl.	€ 5,90



SERTMETAL TORNA UCU

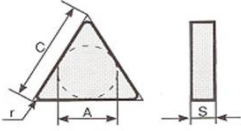

TNUN-1603..	
A=9,52 C=16,5 S=3,18	
Normal	€ 2,60
Kaplamalı	€ 3,50
Çok kapl.	€ 3,70

TNUN-2204..	
A=12,7 C=22 S=4,76	
Normal	€ 4,40
Kaplamalı	€ 5,50
Çok kapl.	€ 5,90

TNUN-1604..	
A=9,52 C=16,5 S=4,76	
Normal	€ 3,20
Kaplamalı	€ 4,10
Çok kapl.	€ 4,30

SERTMETAL FREZE UCU

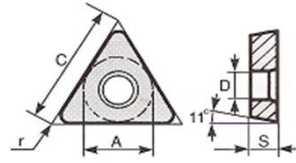

TPMA-1604..	
A=9,52 C=16,5 D=3,81 S=4,76	
Normal	€ 2,40
Kaplamalı	€ 3,00
Çok kapl.	€ 3,20

TPMA-2204..	
A=12,7 C=22 D=5,16 S=4,76	
Normal	€ 4,10
Kaplamalı	€ 5,30
Çok kapl.	€ 5,70

SERTMETAL FREZE UCU

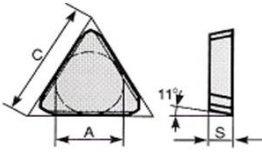

TPAN-1604..	
A=9,52 C=16,5 S=4,76	
Normal	€ 4,10
Kaplamalı	€ 5,20
Çok kapl.	€ 5,50

SERTMETAL TORNA UCU

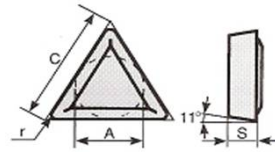

TPMR-1103..	
A=6,35 C=11 S=3,18	
Normal	€ 2,10
Kaplamalı	€ 2,30
Çok kapl.	€ 2,40

TPMR-2204..	
A=12,7 C=22 S=4,76	
Normal	€ 4,40
Kaplamalı	€ 5,50
Çok kapl.	€ 5,90

TPMR-1603..	
A=9,52 C=16,5 S=3,18	
Normal	€ 2,70
Kaplamalı	€ 3,00
Çok kapl.	€ 3,10

SERTMETAL TORNA UCU

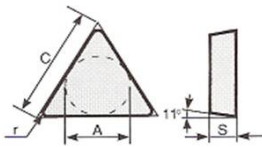

TPGN-1103..	
A=6,35 C=11 S=3,18	
Normal	€ 3,90
Kaplamalı	€ 4,40
Çok kapl.	€ 4,70

TPGN-1603..	
A=9,52 C=16,5 S=3,18	
Normal	€ 5,40
Kaplamalı	€ 5,90
Çok kapl.	€ 6,20

SERTMETAL TORNA UCU

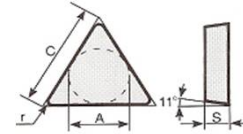

TPUN-1103..	
A=6,35 C=11 S=3,18	
Normal	€ 1,60
Kaplamalı	€ 2,10
Çok kapl.	€ 2,20

TPUN-2204..	
A=12,7 C=22 S=4,76	
Normal	€ 3,50
Kaplamalı	€ 4,30
Çok kapl.	€ 4,70

TPUN-1603..	
A=9,52 C=16,5 S=3,18	
Normal	€ 2,00
Kaplamalı	€ 2,70
Çok kapl.	€ 2,80

SERTMETAL FREZE UCU

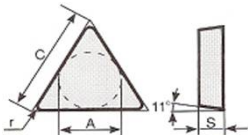

TPKA-1604..	
A=9,52 C=16,5 S=4,76	
Normal	€ 4,10
Kaplamalı	€ 5,20
Çok kapl.	€ 5,50

SERTMETAL TORNA UCU

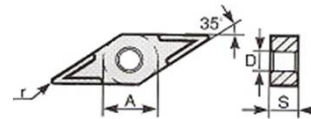

VNMG-2204..	
A=12,7 D=5,16 S=4,76	
Normal	€ 7,70
Kaplamalı	€ 10,70
Çok kapl.	€ 11,60

SERTMETAL FREZE UCU

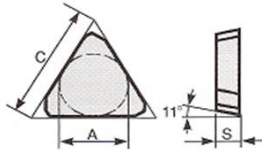

TPKN-1103..	
A=6,35 C=11 S=3,18	
Normal	€ 2,20
Kaplamalı	€ 2,90
Çok kapl.	€ 3,00

TPKN-2204..	
A=12,7 C=22 S=4,76	
Normal	€ 3,60
Kaplamalı	€ 4,60
Çok kapl.	€ 5,20

TPKN-1603..	
A=9,52 C=16,5 S=3,18	
Normal	€ 2,40
Kaplamalı	€ 3,10
Çok kapl.	€ 3,50

SERTMETAL TORNA UCU

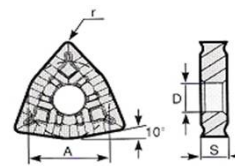

WNMG-0804..	
A=12,7 D=5,16 S=4,76	
Normal	€ 3,50
Kaplamalı	€ 3,90
Çok kapl.	€ 4,20

SERTMETAL FREZE UCU

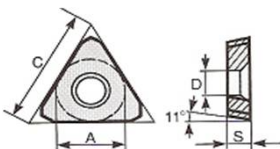

TPKX-1604..	
A=9,52 C=16,5 D=3,81 S=4,76	
Normal	€ 3,00
Kaplamalı	€ 3,90
Çok kapl.	€ 4,40

SERTMETAL DIŞ UCU

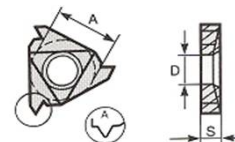

WIFD-1603..	
A=9,52 D=3,85 S=3,68	
Kaplamalı	€ 6,10

KATER ALTLIĞI

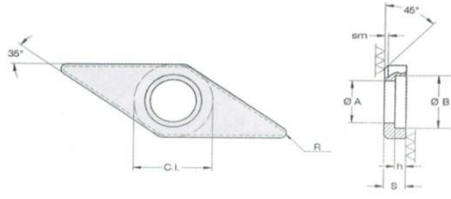

WSVN-2-0001	€ 1,60
A=8,4 d1=5,6 d2=6,85 S=3,18 VNMG için	

WSVN-2-0002	€ 1,60
A=8,4 d1=5,6 d2=6,85 S=3,18 VNMG için	

KATER ALTLIĞI

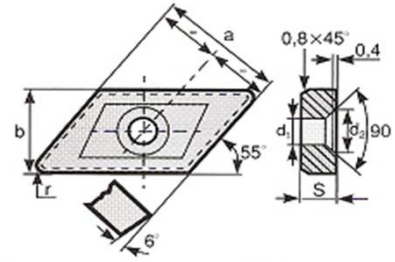

WKS-16R/L	€ 2,40
b=9,4 a=14,5 d1=3,3	
d2=6 S=4,76 KNUX için	

KATER ALTLIĞI

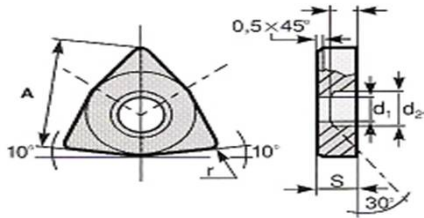

WSWN-2-0001	€ 1,70
A=12,5 d1=6,6 d2=7,7 S=3,18 WNMG için	

WSWN-3-0001	€ 2,60
A=12,5 d1=6,6 d2=7,7 S=3,18 WNMG için	

KATER ALTLIĞI

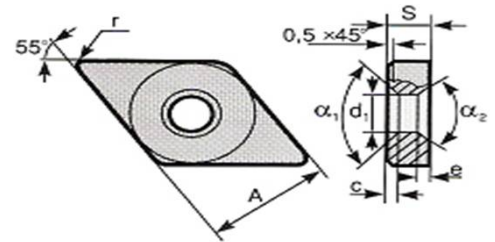

WSDN-2-0001	€ 1,30
A=8,4 d1=5,6 S=3,18 r=0,8	
DNMA, DNMG, DNMM DNMX için	

WSDN-3-0001	€ 1,90
A=11,8 d1=6,6 S=3,18 r=1,2	
DNMA, DNMG, DNMM DNMX için	

WSDN-4-0004	€ 2,70
A=12,4 d1=7 S=4,76 r=1	
DNMA, DNMG, DNMM DNMX için	

KATER ALTLIĞI

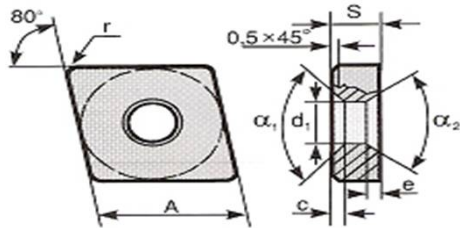

WSCN-3-0001	€ 1,80
A=11,8 d1=6,6 S=3,18 r=1,2 CNMA, CNMG, CNMM CNMX için	

WSCN-3-0002	€ 3,00
A=14,6 d1=8,05 S=4,76 r=1,4 CNMA, CNMG, CNMM CNMX için	

WSCN-3-0003	€ 4,10
A=18,0 d1=9,75 S=7,76 r=1,6 CNMA, CNMG, CNMM CNMX için	

KATER ALTLIĞI

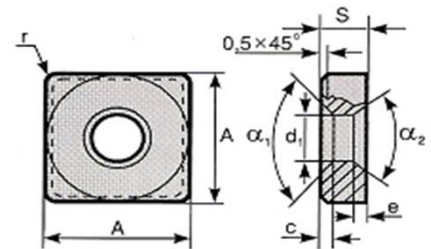

WSSN-3-0004	€ 1,70
A=11,8 d1=6,6 S=3,18 r=1,2	
SNMA, SNMG, SNMM SNMX için	

WSSN-3-0023	€ 3,10
A=16,6 d1=8,07 S=4,76 r=1,6	
SNMA, SNMG, SNMM SNMX için	

WSSN-3-0005	€ 4,10
A=18,0 d1=9,75 S=4,76 r=1,2	
SNMA, SNMG, SNMM SNMX için	

WOLFRAM-CARB

KATER ALTLIĞI

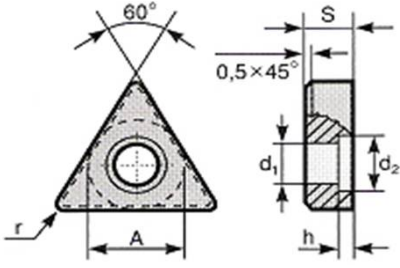

WSTN-3-0016

A=8,9 d1=5 S=3,18

r=0,8 c=1,3 e=0,7

TNMA, TNMG, TNMM
TNMX için

€ 1,60

WSTN-3-0015

A=11,8 d1=6,6 S=3,18

r=0,8 c=1,3 e=0,7

TNMA, TNMG, TNMM
TNMX için

€ 2,20

WSTN-2-0002

A=9,4 d1=5,2 d2=6,2 S=3,18

r=0,8 h=2,2

TNMA, TNMG, TNMM
TNMX için

€ 1,70

WSTN-2-1020

A=9,30 d1=5,6 d2=6,5

S=3,18 r=1,2 h=2,5

TNMA, TNMG, TNMM
TNMX için

€ 1,60

WSTN-2-1018

A=12,45 d1=6,26 d2=7,25

S=3,18 r=0,8 h=2,45

TNMA, TNMG, TNMM
TNMX için

€ 1,60

ATB SERİSİ SERTMETAL KESME KALEMLERİ

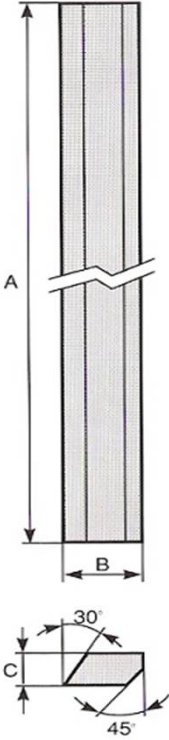

2	x6x165mm	€ 7,20
2	x8x165mm	€ 8,40
2	x10x165mm	€ 9,40
2	x12x165mm	€ 10,50
2	x14x165mm	€ 12,10
2	x16x165mm	€ 13,60
2	x18x165mm	€ 15,50
2	x20x165mm	€ 17,90
2	x22x165mm	€ 19,50
2	x24x165mm	€ 21,10

3	x6x165mm	€ 11,50
3	x8x165mm	€ 11,90
3	x10x165mm	€ 13,50
3	x12x165mm	€ 15,10
3	x14x165mm	€ 15,50
3	x16x165mm	€ 18,60
3	x18x165mm	€ 20,80
3	x20x165mm	€ 24,00
3	x22x165mm	€ 26,10
3	x24x165mm	€ 25,30
3	x26x165mm	€ 30,70
3	x28x165mm	€ 32,80
3	x30x165mm	€ 35,50

4	x8x165mm	€ 14,30
4	x10x165mm	€ 17,60
4	x12x165mm	€ 19,70
4	x14x165mm	€ 22,20
4	x16x165mm	€ 24,40
4	x18x165mm	€ 27,10
4	x20x165mm	€ 31,10
4	x22x165mm	€ 32,80
4	x24x165mm	€ 37,00
4	x26x165mm	€ 39,70
4	x28x165mm	€ 42,60
4	x30x165mm	€ 46,10
4	x32x165mm	€ 19,30
4	x34x165mm	€ 52,20
4	x36x165mm	€ 55,30
4	x40x165mm	€ 61,30

5	x22x165mm	€ 41,00
5	x23x165mm	€ 42,90
5	x24x165mm	€ 44,80
5	x25x165mm	€ 46,70
5	x26x165mm	€ 46,70
5	x30x165mm	€ 56,10

SERTMETAL KESME KALEMLERİ

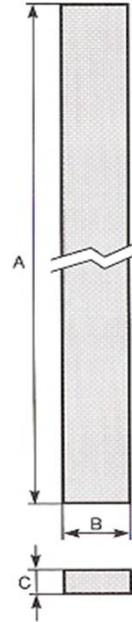

4	x1x100mm	€ 7,70
5	x3x100mm	€ 7,70
5	x4x100mm	€ 7,70
6	x4x100mm	€ 7,70
9	x3x100mm	€ 8,30
10	x2x140mm	€ 9,30
10	x2,5x100mm	€ 8,80
10	x2,5x140mm	€ 11,00
10	x3x100mm	€ 9,60
12	x2,5x100mm	€ 9,90
12	x3x100mm	€ 10,50
12	x3x140mm	€ 15,40
12	x3,5x100mm	€ 12,70
16	x2,5x100mm	€ 12,70
16	x2,5x140mm	€ 17,80
16	x3x100mm	€ 15,40
20	x2,5x100mm	€ 16,50
20	x3x100mm	€ 18,20
20	x3x140mm	€ 25,90
20	x3x160mm	€ 29,60

SERTMETAL TORNA KALEMLERİ

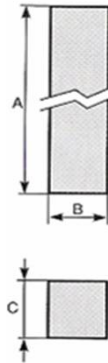

4	x4x100mm	€ 8,80
6	x6x100mm	€ 14,30
8	x8x100mm	€ 22,00
10	x10x100mm	€ 29,70
12	x12x100mm	€ 45,10
14	x14x100mm	€ 58,30
16	x16x100mm	€ 68,20
18	x18x100mm	€ 90,20

DÜĞMECİ ELMASLARI

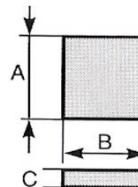

1,5	x10x10mm	€ 1,10
2	x8x5mm	€ 1,10
2	x14x4mm	€ 1,70
2	x30x10mm	€ 2,90

WOLFRAM-CARB

SERTMETAL PANTOĞRAF KALEMLERİ

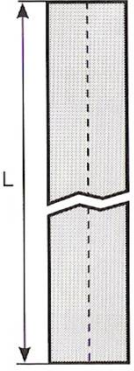

TAŞLANMIŞ

2 x100mm	€ 5,30
2,5 x100mm	€ 5,80
3 x100mm	€ 6,20
4 x80mm	€ 5,70
4 x100mm	€ 7,00
5 x100mm	€ 9,30
6 x100mm	€ 12,10
6 x150mm	€ 23,10
7 x100mm	€ 14,90
8 x60mm	€ 10,40
8 x100mm	€ 17,00
10 x100mm	€ 23,00
12 x100mm	€ 31,90
12 x150mm	€ 56,10
14 x100mm	€ 42,90
16 x100mm	€ 52,80
18 x100mm	€ 60,50
20 x100mm	€ 84,70

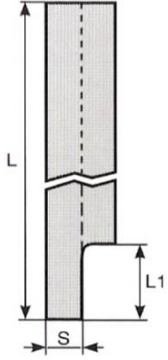
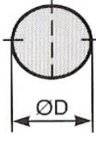

TAŞLANMIŞ-BİLENMİŞ

3 x100mm	€ 6,50
4 x100mm	€ 7,40
5 x100mm	€ 9,80
8 x60mm	€ 9,90
12 x150mm	€ 59,00
13 x100mm	€ 44,00

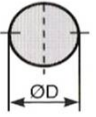

TAŞLANMAMIŞ

5 x100mm	€ 8,70
8 x100mm	€ 16,10
12 x100mm	€ 30,30
18 x100mm	€ 57,50

A/B SERİSİ KAYNAKLI SERTMETAL UÇLAR

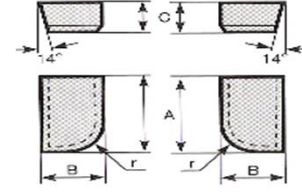

A/B-12	12x8x5mm	€ 1,70
A/B-16	16x10x6mm	€ 2,70
A/B-20	20x12x7mm	€ 3,90
A/B-25	25x14x8mm	€ 6,60
A/B-32	32x18x10mm	€ 16,50
A/B-40	40x22x12mm	€ 27,50
A/B-50	50x25x14mm	€ 49,50

C SERİSİ KAYNAKLI SERTMETAL UÇLAR

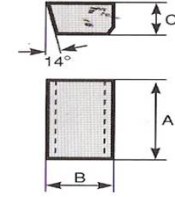

C-16	16x10x6mm	€ 2,80
C-20	20x12x7mm	€ 4,40
C-25	25x14x8mm	€ 7,70

E SERİSİ KAYNAKLI SERTMETAL UÇLAR

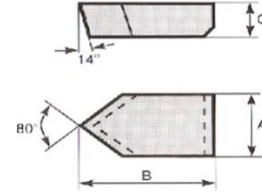

E-10	10x18x5mm	€ 2,20
E-16	16x22x7mm	€ 6,60
E-20	20x25x8mm	€ 9,90
E-25	25x28x9mm	€ 15,40

SERTMETAL PARMAK FREZELER



2mm	€ 19,80
3mm	€ 19,80
4mm	€ 16,50
5mm	€ 18,70
6mm	€ 22,00
7mm	€ 33,00
8mm	€ 33,00
10mm	€ 46,20
12mm	€ 60,50
14mm	€ 85,80
16mm	€ 121,00
18mm	€ 137,50
20mm	€ 159,50

F SERİSİ KAYNAKLI SERTMETAL UÇLAR

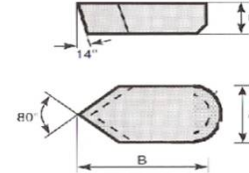

F-6	6x8x5mm	€ 1,40
F-8	8x10x6mm	€ 1,40
F-10	10x12x7mm	€ 2,80
F-12	12x14x8mm	€ 4,40
F-16	16x18x10mm	€ 9,90

BSM/F SERİSİ KAYNAKLI SERTMETAL UÇLAR

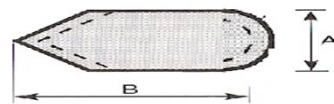

20x4x3	20x4x3mm	€ 1,10
30x5x4	30x5x4mm	€ 2,10
30x8x6	30x8x6mm	€ 3,90

SERTMETAL PARMAK FREZE

TEK AĞIZ KISA TİP



5	5x20x50mm	€ 15,00
6	6x25x80mm	€ 28,30
8	8x25x80mm	€ 37,30

SERTMETAL PARMAK FREZE

2 AĞIZ UZUN TİP



4	4x25x60mm	€ 25,60
5	5x25x75mm	€ 26,60
6	6x30x75mm	€ 28,30
8	8x30x75mm	€ 37,30
8	8x45x100mm	€ 48,10
10	10x40x100mm	€ 52,20
10	10x65x150mm	€ 89,30
12	12x40x100mm	€ 61,10
16	16x45x100mm	€ 127,80

SERTMETAL PARMAK FREZE

2 AĞIZ KISA TİP



2	2x7x38mm	€ 13,50
2,5	2,5x7x38mm	€ 13,50
5	5x16x50mm	€ 15,00
6	6x16x50mm	€ 17,50
8	8x20x60mm	€ 22,80
10	10x22x76mm	€ 33,70
12	12x26x75mm	€ 45,60
14	14x32x83mm	€ 68,20
16	16x32x92mm	€ 77,50
20	20x38x100mm	€ 136,80
20	20x45x100mm	€ 136,80

SERTMETAL PARMAK FREZE

3 AĞIZ KISA TİP



6	6x17x50mm	€ 17,50
10	10x25x63mm	€ 33,70
12	12x28x85mm	€ 45,60

SERTMETAL PARMAK FREZE

4 AĞIZ UZUN TİP



4	4x25x60mm	€ 25,60
5	5x25x75mm	€ 26,60
6	6x30x75mm	€ 28,30
10	10x40x100mm	€ 52,20
10	10x65x150mm	€ 89,30
12	12x75x100mm	€ 125,60
14	14x75x150mm	€ 137,30
20	20x45x100mm	€ 172,50
20	20x75x150mm	€ 206,70

SERTMETAL PARMAK FREZE

4 AĞIZ KISA TİP



2	2x8x38mm	€ 13,50
2	2x10x40mm	€ 13,50
2,5	2,5x10x40mm	€ 13,50
3	3x9x38mm	€ 12,00
3	3x12x40mm	€ 12,00
3,5	3,5x12x40mm	€ 14,30
4	4x12x40mm	€ 13,10
4	4x14x50mm	€ 13,10
5	5x14x50mm	€ 15,00
5	5x16x50mm	€ 15,00
6	6x17x50mm	€ 17,50
6	6x19x57mm	€ 17,50
6	6x22x63mm	€ 17,50
7	7x18x60mm	€ 25,80
10	10x20x72mm	€ 33,70
10	10x25x72mm	€ 33,70
12	12x27x83mm	€ 45,60
14	14x27x83mm	€ 68,20
14	14x35x82mm	€ 68,20
16	16x32x92mm	€ 77,50
18	18x32x92mm	€ 125,60
18	18x35x100mm	€ 125,60
20	20x36x100mm	€ 136,80
20	20x40x105mm	€ 136,80
25	25x45x120mm	€ 198,50

SERTMETAL PARMAK FREZE

4 AĞIZ UZUN TİP-RADYUS BAŞLI



3	3x20x60mm	€ 26,60
4	4x25x60mm	€ 27,70
5	5x25x75mm	€ 29,90
6	6x28x75mm	€ 32,50
8	8x30x75mm	€ 42,60

SERTMETAL PARMAK FREZE

4 AĞIZ KISA TİP-RADYUS BAŞLI



2	2x8x38mm	€ 15,00
2,5	2,5x9x38mm	€ 16,00
3	3x10x38mm	€ 14,10
4	4x13x50mm	€ 15,70
5	5x17x50mm	€ 19,40
6	6x20x57mm	€ 21,30
8	8x20x64mm	€ 28,10
10	10x21x72mm	€ 41,70

SERTMETAL MATKAP UCU



4	4x20x55mm	€ 11,80
5	5x25x60mm	€ 14,90
6	6x25x65mm	€ 20,50
8	8x35x80mm	€ 37,60
9	9x40x85mm	€ 42,80



KILAVUZ VE PAFTA TAKIMLARI



MM

264800301

€ 385,00

M.3-12

m3-4-5-6-7-8-9-10-11-12

Kılavuz kolu (2)-Pafta kolu (5)

264800401

€ 352,00

M.5-12

m5-6-7-8-9-10-11-12

Kılavuz kolu (2)-Pafta kolu (4)

264800601

€ 759,00

M.3-24

m3-4-5-6-8-10-12-14-16-18-20-22-24

Kılavuz kolu (2)-Pafta kolu (7)

264800701

€ 1.395,00

M.5-30

m5-6-8-10-12-14-16-18-20-22-24-27-30

Kılavuz kolu (3)-Pafta kolu (7)



MM

49501

€ 125,00

M.3-12

m3-4-5-6-8-10-12

Kılavuz kolu (1)-Pafta kolu (1)

Cırcırlı Kılavuz kolu (1)+Diş tarağı

10360009046

€ 228,50

M.3-12

m3-4-5-6-8-10-12

Kılavuz kolu (2)-Pafta kolu (5)

Tornavida+Cırcırlı Kılavuz kolu (2)

Diş tarağı-Matkap ucu (7)

10360009146

€ 350,30

M.3-20

m3-4-5-6-8-10-12-14-16-18-20

Kılavuz kolu (2)-Pafta kolu (6)

Tornavida+Cırcırlı Kılavuz kolu (2)

Tornavida+Diş tarağı

KILAVUZ VE PAFTA TAKIMLARI



Mf

264801002

€ 286,00

Mf.3-12

mf3x0,35-4x0,5-5x0,5-6x0,75-8x0,75

8x1-10x1-12x1,5

Kılavuz kolu (2)-Pafta kolu (5)

264801102

€ 512,00

Mf.6-20

mf6x0,75-8x0,75-8x1-10x1-12x1-12x1,5

14x1,25-14x1,5-16x1,5-18x1,5-20x1,5

Kılavuz kolu (2)-Pafta kolu (5)

264801202

€ 748,00

Mf.6-24

mf6x0,75-8x0,75-8x1-10x1-12x1-12x1,5

14x1,25-14x1,5-16x1,5-18x1,5-20x1,5

22x1,5-24x1,5

Kılavuz kolu (2)-Pafta kolu (6)



UNC

264805003

€ 275,00

UNC 1/4"-1/2"

1/4-5/16-3/8-7/16-1/2

Kılavuz kolu (2)-Pafta kolu (4)

264805103

€ 480,00

UNC 1/4"-3/4"

1/4-5/16-3/8-7/16-1/2-5/8-3/4

Kılavuz kolu (2)-Pafta kolu (5)

264805303

€ 730,00

UNC 1/4"-1"

1/4-5/16-3/8-7/16-1/2-5/8-3/4-7/8-1

Kılavuz kolu (2)-Pafta kolu (6)

264805403

€ 1.830,00

UNC 1/4"-1.1/2"

1/4-5/16-3/8-7/16-1/2-5/8-3/4-7/8-1

1.1/8-1.1/4-1.3/8-1.1/2

Kılavuz kolu (3)-Pafta kolu (7)

KILAVUZ VE PAFTA TAKIMLARI



BSW

264803010

€ 319,00

BSW 1/8" - 1/2"

1/8-3/16-1/4-5/16-3/8-7/16-1/2
Kılavuz kolu (2)-Pafta kolu (5)

264803110

€ 275,00

BSW 1/4" - 1/2"

1/4-5/16-3/8-7/16-1/2
Kılavuz kolu (2)-Pafta kolu (4)

264803210

€ 480,00

BSW 1/4" - 3/4"

1/4-5/16-3/8-7/16-1/2-5/8-3/4
Kılavuz kolu (2)-Pafta kolu (5)

264803410

€ 730,00

BSW 1/4" - 1"

1/4-5/16-3/8-7/16-1/2-5/8-3/4-7/8-1
Kılavuz kolu (2)-Pafta kolu (6)

264803510

€ 1.830,00

BSW 1/4" - 1.1/2"

1/4-5/16-3/8-7/16-1/2-5/8-3/4-7/8-1
1.1/8-1.1/4-1.3/8-1.1/2
Kılavuz kolu (3)-Pafta kolu (7)



UNF

264806004

€ 255,00

UNF 1/4" - 1/2"

1/4-5/16-3/8-7/16-1/2
Kılavuz kolu (2)-Pafta kolu (4)

264806104

€ 425,00

UNF 1/4" - 3/4"

1/4-5/16-3/8-7/16-1/2-5/8-3/4
Kılavuz kolu (2)-Pafta kolu (5)

264806304

€ 640,00

UNF 1/4" - 1"

1/4-5/16-3/8-7/16-1/2-5/8-3/4-7/8-1
Kılavuz kolu (2)-Pafta kolu (6)

KILAVUZ VE PAFTA TAKIMLARI



G-BSP

264802014

€ 627,00

G-BSP 1/8" - 1"

1/8-1/4-3/8-1/2-3/4-1
Kılavuz kolu (3)-Pafta kolu (5)

264802114

€ 836,00

G-BSP 1/8" - 1"

1/8-1/4-3/8-1/2-5/8-3/4-7/8-1
Kılavuz kolu (3)-Pafta kolu (5)

264802214

€ 1.785,00

G-BSP 1/4" - 1.1/2"

1/4-3/8-1/2-3/4-1-1.1/4-1.1/2
Kılavuz kolu (3)-Pafta kolu (6)

DÖKÜM KILAVUZ KOLLARI



No:0

130mm

€ 4,60

m1-8

1/16-1/4

No:1

176mm

€ 4,80

m1-10

1/16-3/8 G1/8

No:1.1/2

176mm

€ 4,80

m1-12

1/16-1/2 G1/8

No:2

280mm

€ 7,90

m4-12

5/32-1/2 G1/8

No:3

380mm

€ 15,60

m5-20

7/32-3/4 G1/8-1/2

No:4

505mm

€ 29,40

m11-27

7/16-1 G1/4-3/4

No:5L

700mm

€ 40,80

m13-32

1/2-1,1/4 G1/4-1

ÇELİK KILAVUZ KOLLARI



No:0	130mm	€ 7,50
m1-8	1/16-1/4	
No:1	180mm	€ 8,60
m1-10	1/16-3/8 G1/8	
No:1.1/2	205mm	€ 8,60
m1-12	1/16-1/2 G1/8	
No:2	280mm	€ 15,40
m4-12	5/32-1/2 G1/8	
No:3	380mm	€ 29,50
m5-20	7/32-3/4 G1/8-1/2	
No:4	500mm	€ 52,00
m11-27	7/16-1 G1/4-3/4	
No:5	700mm	€ 61,00
m13-32	1/2-1,1/4 G1/4-1	
No:6	1000mm	€ 102,00
m18-42	3/4-1,1/2 G1/2-1,1/4	
No:7	1250mm	€ 114,00
m25-52	1-2,1/8 G3/4-2,1/4	
No:8	1250mm	€ 276,00
m25-64	1-2,1/2 G3/4-3	

CIRCIRLI KILAVUZ KOLLARI

No:1	85mm	€ 10,20
m3-10	1/8-3/8	
No:10	250mm	€ 16,80
m3-10	1/8-3/8	
No:2	100mm	€ 12,60
m5-12	7/32-1/2	
No:20	300mm	€ 20,40
m5-12	7/32-1/2	

DÖKÜM PAFTA KOLLARI



16x5	160mm	€ 3,60
m1-2,6	BSW 1/16-3/32	
20x5	200mm	€ 3,60
m3-4	BSW 1/8-5/32	
20x7	200mm	€ 3,60
m4,5-6	BSW 3/16-1/4	
25x9	224mm	€ 4,40
m7-9	BSW 5/16	
30x11	280mm	€ 7,10
m10-11	BSW 3/8-7/16	
38x10	315mm	€ 11,60
m-ince 12-15	G 1/4	
38x14	315mm	€ 11,60
m12-14	BSW 1/2-9/16	
45x14	450mm	€ 14,30
m-ince 16-20	G 3/8-1/2	
45x18	450mm	€ 14,30
m16-20	BSW 5/8-13/16	
55x16	560mm	€ 18,80
m-ince 22-26	G 5/8-3/4	
55x22	560mm	€ 18,80
m22-24	BSW 7/8-1	
65x18	630mm	€ 26,40
m-ince 27-36	G 7/8-1	
65x25	630mm	€ 26,40
m27-36	BSW 1,1/8-1,3/8	



PAFTALAR



METRİK DİŞ

MM	Dın:223
1x0,25	€ 12,30
1,2x0,25	€ 12,30
1,4x0,3	€ 12,30
1,7x0,35	€ 12,30
2x0,4	€ 10,70
2,3x0,4	€ 10,70
2,5x0,45	€ 10,70
2,6x0,45	€ 10,70
3x0,5	€ 5,10
3,5x0,6	€ 7,90
4x0,7	€ 5,10
4,5x0,75	€ 7,90
5x0,8	€ 5,40
6x1	€ 5,40
7x1	€ 8,60
8x1,25	€ 5,70
10x1,5	€ 8,60
12x1,75	€ 13,90
14x2	€ 13,90
16x2	€ 21,50
18x2,5	€ 21,50
20x2,5	€ 21,50
22x2,5	€ 42,00
24x3	€ 42,00
27x3	€ 56,20
30x3,5	€ 56,20
33x3,5	€ 60,00
36x4	€ 60,00
42x4,5	€ 98,00

METRİK DİŞ

MM	Dın:223
SOL	
20x2,5	€ 32,60

KALIN DİŞ

BSW	Dın:223
1/8x40	€ 11,20
5/32x32	€ 11,20
3/16x24	€ 11,20
1/4x20	€ 11,20
5/16x18	€ 12,80
3/8x16	€ 14,20
7/16x14	€ 16,50
1/2x12	€ 18,50
9/16x12	€ 22,90
5/8x11	€ 25,00
3/4x10	€ 25,00
7/8x9	€ 42,80
1x8	€ 42,80
1,1/8x7	€ 64,70
1,1/4x7	€ 64,70
1,3/8x6	€ 64,70
1,1/2x6	€ 64,70

METRİK İNCE DİŞ

Mf	Dın:223
3x0,35	€ 11,80
4x0,5	€ 11,80
5x0,5	€ 11,80
6x0,75	€ 10,20
8x0,75	€ 10,70
8x1	€ 10,70
9x1	€ 16,10
10x1	€ 12,30
10x1,25	€ 12,30
12x1	€ 15,70
12x1,25	€ 15,70
12x1,5	€ 15,20
13x1,5	€ 20,70
14x1	€ 20,70
14x1,25	€ 17,30
14x1,5	€ 17,30
16x1	€ 28,10
16x1,25	€ 28,10
16x1,5	€ 22,10
18x1	€ 25,80
18x1,5	€ 22,10
18x2	€ 26,40
20x1,5	€ 22,10
20x2	€ 26,40
22x1,25	€ 42,70
22x1,5	€ 38,50
22x2	€ 42,70
24x1,5	€ 38,50
24x2	€ 42,70
26x1,5	€ 55,10
27x1,5	€ 63,00
28x1	€ 63,00
28x1,5	€ 63,00
30x1,5	€ 63,00
30x2	€ 63,00
30x3	€ 63,00
32x1,5	€ 63,00
32x2	€ 63,00
33x1,5	€ 63,00
36x1,5	€ 63,00
36x18	€ 63,00
38x1,5	€ 102,00
39x1,5	€ 102,00
42x18	€ 102,00
48x2	€ 170,00

KONİK BORU DİŞ

NPT	
1/8x27	€ 40,20
1/4x18	€ 49,20
3/8x18	€ 62,40
1/2x14	€ 62,40
3/4x14	€ 99,60
1x11,5	€ 147,60

İNCE DİŞ

UNF	Dın:223
8-36	€ 11,80
10-32	€ 11,80
12-32	€ 11,80
14-24	€ 11,80
1/4x28	€ 11,20
5/16x24	€ 12,80
3/8x24	€ 14,20
7/16x20	€ 16,50
1/2x20	€ 18,50
9/16x18	€ 22,90
5/8x18	€ 25,00
3/4x16	€ 25,00
7/8x14	€ 42,80
1x12	€ 42,80
1x14	€ 42,80
1,1/8x12	€ 64,70
1,1/4x12	€ 64,70
1,3/8x12	€ 64,70
1,1/2x12	€ 64,70

İNCE DİŞ

UNF	Dın:223
SOL	
1/2x20	€ 31,80

KALIN DİŞ

UNC	Dın:223
1/2x13	€ 18,50
1,1/2x6	€ 64,70

İNCE DİŞ

BSF	
3/16x32	€ 11,20
7/8x11	€ 43,90

BORU DİŞ

G-BSP	Dın:5158
1/8x28	€ 16,60
1/4x19	€ 16,90
3/8x19	€ 22,50
1/2x14	€ 22,50
5/8x14	€ 40,70
3/4x14	€ 40,70
7/8x14	€ 54,60
1x11	€ 54,60
1,1/8x11	€ 92,00
1,1/4x11	€ 92,00
1,3/8x11	€ 160,50
1,1/2x11	€ 160,50

EL KILAVUZLARI



METRİK DİŞ		
MM	3'lü	Dın:352
2x04		€ 14,10
2,5x0,45		€ 14,10
2,6x0,45		€ 14,10
3x0,5		€ 7,20
3,5x0,6		€ 10,50
4x0,7		€ 7,20
5x0,8		€ 8,10
6x1		€ 8,10
7x1		€ 13,20
8x1,25		€ 10,50
10x1,5		€ 13,80
12x1,75		€ 18,00
14x2		€ 20,70
16x2		€ 25,80
18x2,5		€ 33,90
20x2,5		€ 39,00
22x2,5		€ 48,30
24x3		€ 60,00
27x3		€ 93,00
30x3,5		€ 126,00
33x3,5		€ 162,00
36x4		€ 192,00
42x4,5		€ 276,00

METRİK DİŞ		
MM	3'lü	Dın:352
SOL		
3x0,5		€ 12,60
4x0,7		€ 12,60
5x0,8		€ 14,40
6x1		€ 15,00
8x1,25		€ 17,10
10x1,5		€ 23,40
12x1,75		€ 30,60
14x2		€ 33,90
16x2		€ 42,30
18x2,5		€ 54,90
20x2,5		€ 61,50
22x2,5		€ 75,00
24x3		€ 105,00
27x3		€ 168,00
30x3,5		€ 204,00
33x3,5		€ 252,00

KALIN DİŞ		
UNC	3'lü	Dın:352
10x24		€ 13,50
1/4x20		€ 13,50
3/8x16		€ 16,80
1/2x13		€ 25,80
1,1/2x6		€ 202,20

METRİK İNCE DİŞ		
Mf	2'li	Dın:2181
3x0,35		€ 14,40
4x0,5		€ 14,40
5x0,5		€ 14,40
6x0,75		€ 12,80
8x0,75		€ 12,80
8x1		€ 12,80
9x0,75		€ 14,40
9x1		€ 14,40
10x1		€ 12,80
10x1,25		€ 14,40
11x1		€ 18,60
12x0,75		€ 18,60
12x1		€ 18,60
12x1,25		€ 18,60
12x1,5		€ 17,00
13x1,5		€ 28,40
14x1		€ 28,40
14x1,25		€ 21,40
14x1,5		€ 18,40
16x1		€ 31,40
16x1,5		€ 22,40
18x1		€ 34,40
18x1,5		€ 25,80
18x2		€ 34,40
20x1		€ 43,20
20x1,5		€ 31,40
20x2		€ 43,20
22x1		€ 44,80
22x1,5		€ 44,80
22x2		€ 44,80
24x1,5		€ 47,00
24x2		€ 60,00
25x1,5		€ 88,00
27x1,5		€ 88,00
28x1,5		€ 104,00
28x2		€ 104,00
29x1,5		€ 104,00
30x1,5		€ 122,00
30x2		€ 122,00
32x1,5		€ 122,00
32x2		€ 122,00
33x1,5		€ 122,00
36x1,5		€ 157,00

METRİK İNCE DİŞ		
Mf	2'li	Dın:2181
SOL		
10x1		€ 19,00

İNCE DİŞ		
BSF	2'li	
3/16x32		€ 9,00
7/8x11		€ 45,00

KALIN DİŞ		
BSW	3'lü	Dın:352
1/8x40		€ 13,80
5/32x32		€ 13,80
3/16x24		€ 13,50
1/4x20		€ 13,50
5/16x18		€ 15,00
3/8x16		€ 16,80
7/16x14		€ 21,30
1/2x12		€ 25,80
9/16x12		€ 33,60
5/8x11		€ 37,80
3/4x10		€ 50,70
7/8x9		€ 67,50
1x8		€ 77,70
1,1/8x7		€ 119,70
1,1/4x7		€ 134,70
1,3/8x6		€ 175,20
1,1/2x6		€ 202,20

İNCE DİŞ		
UNF	2'li	Dın:2181
8-36		€ 9,00
10-32		€ 9,00
1/4x28		€ 9,00
5/16x24		€ 10,00
3/8x24		€ 11,20
7/16x20		€ 14,20
1/2x20		€ 17,20
9/16x18		€ 22,40
5/8x18		€ 25,20
3/4x16		€ 33,80
7/8x14		€ 45,00
1x12		€ 51,80
1x14		€ 56,00
1,1/8x12		€ 79,80
1,1/4x12		€ 89,80
1,3/8x12		€ 116,80
1,1/2x12		€ 134,80

BORU DİŞ		
G-BSP	2'li	Dın:5157
1/8x28		€ 11,80
1/4x19		€ 13,20
3/8x19		€ 19,20
1/2x14		€ 27,40
5/8x14		€ 38,80
3/4x14		€ 38,80
7/8x14		€ 65,20
1x11		€ 65,20
1,1/8x11		€ 114,00
1,1/4x11		€ 114,00
1,3/8x11		€ 156,00
1,1/2x11		€ 156,00
3x11		€ 2.148,00

MAKİNE KILAVUZLARI



METRİK DİŞ

MM	DÜZ	HELİS	SON
2-10mm	Din:371	Din:371	Din:352
12-42mm	Din:376	Din:376	
2x0,4	€ 8,40	€ 9,00	
2,5x0,45	€ 8,40	€ 9,00	
3x0,5	€ 6,00	€ 7,60	€ 4,00
3,5x0,6	€ 6,70	€ 8,30	
4x0,7	€ 6,00	€ 7,60	€ 4,00
5x0,8	€ 6,40	€ 8,40	€ 4,30
6x1	€ 6,40	€ 8,40	€ 4,60
8x1,25	€ 8,00	€ 10,20	€ 5,50
10x1,5	€ 10,00	€ 12,80	€ 6,60
12x1,75	€ 11,80	€ 15,00	€ 9,50
14x2	€ 15,50	€ 19,30	€ 12,60
16x2	€ 17,10	€ 21,40	€ 17,40
18x2,5	€ 27,60	€ 31,80	€ 21,60
20x2,5	€ 38,40	€ 42,00	€ 24,00
22x2,5	€ 42,00	€ 55,20	€ 34,20
24x3	€ 45,60	€ 57,60	€ 37,40
27x3	€ 72,00	€ 93,60	
30x3,5	€ 76,80	€ 98,40	
33x3,5	€ 108,00	€ 140,40	
36x4	€ 176,00	€ 222,00	
42x4,5	€ 261,00	€ 336,00	

KALIN DİŞ

BSW	DÜZ	HELİS	SON
1/8-1/2	Din:371	Din:371	Din:352
9/16-1 1/2	Din:376	Din:376	
1/8x40	€ 10,30	€ 12,80	€ 4,60
5/32x32	€ 10,30	€ 12,80	€ 4,60
3/16x24	€ 10,30	€ 12,80	€ 4,50
1/4x20	€ 10,30	€ 12,80	€ 4,50
5/16x18	€ 13,10	€ 16,10	€ 5,00
3/8x16	€ 14,60	€ 17,60	€ 5,60
7/16x14	€ 17,40	€ 21,70	€ 7,10
1/2x12	€ 17,40	€ 21,70	€ 8,60
9/16x12	€ 26,50	€ 32,00	€ 11,20
5/8x11	€ 26,50	€ 32,00	€ 12,60
3/4x10	€ 51,60	€ 63,80	€ 16,90
7/8x9	€ 62,40	€ 78,00	€ 22,50
1x8	€ 70,80	€ 87,60	€ 25,90
1 1/4x7	€ 99,00	€ 111,60	
1 3/8x6	€ 206,40	€ 243,60	
1 1/2x6	€ 206,40	€ 243,60	

KALIN DİŞ

UNC	DÜZ	HELİS	SON
	Din:376	Din:376	Din:352
3/8x16	€ 14,60	€ 17,60	€ 5,60
1/2x13	€ 17,40	€ 21,70	€ 8,60

METRİK İNCE DİŞ

Mf	DÜZ	HELİS	SON
	Din:374	Din:374	Din:2181
5x0,5	€ 13,10	€ 14,80	
6x0,75	€ 13,10	€ 14,80	€ 6,40
8x0,75	€ 13,10	€ 14,80	€ 6,40
8x1	€ 13,10	€ 14,80	€ 6,40
10x1	€ 15,10	€ 17,40	€ 6,40
10x1,25	€ 15,10	€ 17,40	€ 7,20
11x1			€ 9,30
12x1	€ 20,80	€ 22,50	€ 9,30
12x1,25	€ 20,80	€ 22,50	€ 9,30
12x1,5	€ 20,80	€ 22,50	€ 8,50
14x1	€ 26,80	€ 27,50	€ 14,20
14x1,25	€ 26,80	€ 27,50	€ 10,70
14x1,5	€ 26,80	€ 27,50	€ 9,20
16x1	€ 30,00	€ 31,90	
16x1,5	€ 30,00	€ 31,90	€ 11,20
18x1	€ 40,80	€ 45,50	€ 17,20
18x1,5	€ 40,80	€ 45,50	€ 12,90
18x2	€ 40,80	€ 45,50	
20x1	€ 45,60	€ 50,40	
20x1,5	€ 45,60	€ 50,40	€ 15,70
20x2	€ 45,60	€ 50,40	€ 21,60
22x1,5	€ 55,20	€ 61,20	€ 22,40
22x2	€ 55,20	€ 61,20	€ 22,40
24x1	€ 64,80		
24x1,5	€ 64,80	€ 73,20	€ 23,50
24x2	€ 64,80	€ 73,20	€ 30,00
25x1	€ 68,40	€ 77,00	
26x1,5	€ 68,40	€ 77,00	€ 43,90
28x1,5	€ 82,00	€ 88,00	€ 51,90
28x2	€ 82,00	€ 88,00	
30x1,5	€ 92,40	€ 101,00	€ 61,00
30x2	€ 92,40	€ 101,00	€ 61,00
32x1,5	€ 113,00	€ 125,00	€ 61,00
32x2	€ 113,00	€ 125,00	
33x1,5	€ 113,00	€ 125,00	
33x2	€ 113,00	€ 125,00	
36x1,5	€ 142,00	€ 159,00	
42x2	€ 188,00	€ 207,00	

KONİK BORU DİŞ

NPT	DÜZ	HELİS	SON
1/8x27	€ 20,20		€ 13,90
1/4x18	€ 25,20		€ 15,50
3/8x18	€ 31,60		€ 21,40
1/2x14	€ 44,40		€ 26,80
3/4x14	€ 67,20		€ 35,80
1x11,5	€ 96,00		€ 56,20
1 1/4x11,5			€ 85,60
1 1/2x11,5			€ 160,50

MAKİNE KILAVUZLARI



İNCE DİŞ

UNF	DÜZ	HELİS	SON
1/4-3/8 7/16-1.1/2	Din:371 Din:376	Din:371 Din:376	Din:352
10-32	€ 10,30	€ 12,80	
1/4x28	€ 10,30	€ 12,80	€ 4,50
5/16x24	€ 13,10	€ 16,10	€ 5,00
3/8x24	€ 14,60	€ 17,60	€ 5,60
7/16x20	€ 17,40	€ 21,70	€ 7,10
1/2x20	€ 17,40	€ 21,70	€ 8,60
9/16x18	€ 26,50	€ 32,00	€ 11,20
5/8x18	€ 26,50	€ 32,00	€ 12,60
3/4x16	€ 51,60	€ 63,80	€ 16,90
7/8x14	€ 62,40	€ 78,00	€ 22,50
1x12	€ 70,80	€ 87,60	€ 25,90
1x14	€ 70,80	€ 87,60	
1,1/4x12	€ 99,00	€ 111,60	
1,1/2x12	€ 206,40	€ 243,60	

BORU DİŞ

G-BSP	DÜZ	HELİS	SON
	Din:5156	Din:5156	Din:5157
1/8x28	€ 16,10	€ 18,50	€ 5,90
1/4x19	€ 19,80	€ 23,40	€ 6,60
3/8x19	€ 24,00	€ 30,00	€ 9,60
1/2x14	€ 35,30	€ 42,00	€ 13,70
5/8x14	€ 39,60	€ 49,20	
3/4x14	€ 52,30	€ 62,40	€ 19,40
7/8x14	€ 65,20	€ 76,80	
1x11	€ 75,60	€ 96,00	€ 32,60
1,1/8x11	€ 105,60	€ 140,40	
1,1/4x11	€ 144,00	€ 168,00	€ 56,70
1,3/8x11	€ 168,00	€ 220,80	
1,1/2x11	€ 199,20	€ 240,00	€ 77,60
1,3/4x11	€ 261,60	€ 345,60	€ 155,20
3x11			€ 1.074,00

PLASTİK DİŞİ

PG	DÜZ	HELİS	SON
			Din:40430
PG.11x18			€ 24,70

TİTANYUM KAPLI

METRİK DİŞ

MM	DÜZ
2-10mm 12-42mm	Din:371 Din:376
4x0,7	€ 9,80
5x0,8	€ 10,20
6x1	€ 10,70
8x1,25	€ 13,30
10x1,5	€ 17,00
12x1,75	€ 22,60

METRİK İNCE DİŞ

Mf	DÜZ
2-10mm 12-42mm	Din:371 Din:376
10x1,25	€ 19,70

SOMUN İÇİN

METRİK DİŞ

MM	DÜZ
2-10mm 12-42mm	Din:371 Din:376
6x1	€ 17,60
10x1,5	€ 26,40
14x2	€ 46,60

KALIN DİŞ

BSW

DÜZ	DİN
1/8-1/2 9/16-1.1/2	Din:371 Din:376
3/8x16	€ 35,70
7/16x14	€ 42,40
5/8x11	€ 64,60

İNCE DİŞ

UNF

DÜZ	DİN
1/4-3/8 7/16-1.1/2	Din:371 Din:376
1/4x28	€ 25,10
1/2x20	€ 42,40

BORU DİŞ

G-BSP

DÜZ	DİN
	Din:5156
1/2x14	€ 85,90



KOMBİ

METRİK DİŞ

MM	DİN
3x0,5	€ 19,40
4x0,7	€ 19,40
5x0,8	€ 19,40
6x1	€ 21,60
8x1,25	€ 24,70
10x1,5	€ 27,10
12x1,75	€ 31,80

ATLAMALI DİŞ

METRİK DİŞ

MM	DİN
2-10mm 12-42mm	Din:371 Din:376
M.10	€ 16,60
M.14	€ 25,80
M.18	€ 39,00

HELİ-COİL TAKIMLAR



MM

B5101

€ 157,50

3-12

m3-4-5-6-8-10-12

Takıcı (7)-Kırıcı (7)-Matkap ucu (7)

Yay/Adet 15-15-15-15-15-10-10

B5104

€ 153,90

5-12

m5-6-8-10-12

Takıcı (5)-Kırıcı (5)-Matkap ucu (5)

Yay/Adet 15-15-15-10-10

B5131

€ 82,40

5-8

m5-6-8

Takıcı (3)-Kırıcı (3)-Matkap ucu (3)

Yay/Adet 15-15-15

B5130

€ 93,40

6-10

m6-8-10

Takıcı (3)-Kırıcı (3)-Matkap ucu (3)

Yay/Adet 15-15-10

Tapa

B5116

€ 173,00

6-14x1,5 (Tapa için)

m6-8-10-12-14x1,5

Takıcı (5)-Kırıcı (4)

Yay/Adet 15-15-10-10-10

Buji

B5108

€ 178,50

6-14x1,25 (Buji için)

m6-8-10-12-14x1,25

Takıcı (5)-Kırıcı (4)-Matkap ucu (4)

Yay/Adet 15-15-10-10-10

HELİ-COİL TAKIMLAR



BSW

B5122

€ 194,70

1/4" - 1/2"

1/4-5/16-3/8-7/16-1/2

Takıcı (5)-Kırıcı (5)-Matkap ucu (5)

Yay/Adet 25-25-25-10-10

UNC

B5120

€ 182,70

1/4" - 1/2"

1/4-5/16-3/8-7/16-1/2

Takıcı (5)-Kırıcı (5)-Matkap ucu (5)

Yay/Adet 25-25-25-10-10

UNF

B5121

€ 182,70

1/4" - 1/2"

1/4-5/16-3/8-7/16-1/2

Takıcı (5)-Kırıcı (5)-Matkap ucu (5)

Yay/Adet 25-25-25-10-10

BSF

B5123

€ 198,50

1/4" - 1/2"

1/4-5/16-3/8-7/16-1/2

Takıcı (5)-Kırıcı (5)-Matkap ucu (5)

Yay/Adet 25-25-25-10-10

G-BSP

B5124

€ 237,30

1/8" - 1/2"

1/8-1/4-3/8-1/2

Takıcı (4)-Kırıcı (2)-Matkap ucu (3)

Yay/Adet 5-5-5-5-5

NPT

B5126

€ 412,40

1/8" - 1/2"

1/8-1/4-3/8-1/2

Takıcı (4)

Yay/Adet 5-5-5-5-5

HELİ-COİL TAMİR TAKIMLARI



2x0,4	B4001	€ 22,60
-------	-------	---------

Takıcı-Kırıci-Matkap ucu-Yay (20)

3x0,5	B4005	€ 21,60
-------	-------	---------

Takıcı-Kırıci-Matkap ucu-Yay (20)

4x0,7	B4007	€ 21,60
-------	-------	---------

Takıcı-Kırıci-Matkap ucu-Yay (20)

5x0,8	B4009	€ 21,60
-------	-------	---------

Takıcı-Kırıci-Matkap ucu-Yay (20)

6x1	B4010	€ 24,30
-----	-------	---------

Takıcı-Kırıci-Matkap ucu-Yay (20)

8x1	B4013	€ 30,90
-----	-------	---------

Takıcı-Kırıci-Matkap ucu-Yay (20)

8x1,25	B4012	€ 30,90
--------	-------	---------

Takıcı-Kırıci-Matkap ucu-Yay (20)

10x1	B4018	€ 33,00
------	-------	---------

Takıcı-Kırıci-Matkap ucu-Yay (15)

10x1,25	B4017	€ 33,00
---------	-------	---------

Takıcı-Kırıci-Matkap ucu-Yay (15)

10x1,5	B4016	€ 33,00
--------	-------	---------

Takıcı-Kırıci-Matkap ucu-Yay (15)

12x1,25	B4023	€ 37,00
---------	-------	---------

Takıcı-Kırıci-Matkap ucu-Yay (10)

12x1,5	B4022	€ 37,00
--------	-------	---------

Takıcı-Kırıci-Matkap ucu-Yay (10)

12x1,75	B4021	€ 37,00
---------	-------	---------

Takıcı-Kırıci-Matkap ucu-Yay (10)

14x1,5	B4029	€ 41,40
--------	-------	---------

Takıcı-Kırıci-Matkap ucu-Yay (10)

14x2	B4028	€ 41,40
------	-------	---------

Takıcı-Kırıci-Matkap ucu-Yay (10)

16x2	B4032	€ 50,10
------	-------	---------

Takıcı-Yay (10)

18x1,5	B4036	€ 59,40
--------	-------	---------

Takıcı-Yay (5)

18x2,5	B4034	€ 59,40
--------	-------	---------

Takıcı-Yay (5)

20x1,5	B4039	€ 64,40
--------	-------	---------

Takıcı-Yay (5)

20x2,5	B4037	€ 64,40
--------	-------	---------

Takıcı-Yay (5)

22x2,5	B4040	€ 74,10
--------	-------	---------

Takıcı-Yay (5)

24x3	B4043	€ 85,50
------	-------	---------

Takıcı-Yay (5)

HELİ-COİL BUJİ TAMİR TAKIMLARI



12x1,25	ZKG012	€ 44,10
---------	--------	---------

Takıcı-Yay (15)

14x1,25	ZKG014	€ 52,50
---------	--------	---------

Takıcı-Yay (15)

BaerCoil Uygulaması

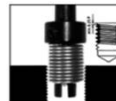
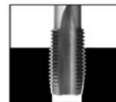

1-DELME

Hasarlı dişi uygun ölçüdeki matkapla delin.(Setler uygun ölçü matkapları içermektedir.)

2-DİŞ AÇMA

Delinen yeni yuvaya BaerCoil kılavuzu ile yeni bir diş çekin.Bu işlem esnasında diş açma yağı kullanınız.

3-BAERCOİL MONTAJI

Takıcıya yerleştirdiğiniz BaerCoil yayı yuvayı ortalarak ve hafifçe bastırarak çevirin.

4-SONLANDIRMA

Yerleştirme işlemi tamamlandığında kırıcı aparatla BaerCoil'in içindeki sıkılaşma için tuttuğunuz parçayı bastırarak kırınız.Kırdığınız bu parçayı bir pense yada kargaburun yardımıyla alınız.

HELİ-COİL TEK KILAVUZLAR



METRİK-İNCE DİŞ	
MM-Mf	SON
2x0,4	€ 7,40
2,5x0,45	€ 7,40
3x0,5	€ 6,50
3,5x0,6	€ 6,50
4x0,7	€ 6,50
5x0,8	€ 6,50
6x1	€ 6,50
7x1	€ 8,10
8x1	€ 8,10
8x1,25	€ 8,10
9x1,25	€ 10,00
10x1	€ 10,00
10x1,25	€ 10,00
10x1,5	€ 10,00
11x1,5	€ 11,20
12x1	€ 13,70
12x1,25	€ 13,70
12x1,5	€ 13,70
12x1,75	€ 11,20
14x1	€ 15,60
14x1,25	€ 15,60
14x1,5	€ 15,60
14x2	€ 15,60
16x1,5	€ 19,70
16x2	€ 19,70
18x1,5	€ 24,60
18x2	€ 24,60
18x2,5	€ 24,60
20x1,5	€ 27,30
20x2	€ 27,30
20x2,5	€ 27,30
22x1,5	€ 31,50
22x2	€ 31,50
22x2,5	€ 31,50
24x1,5	€ 39,70
24x2	€ 39,70
24x3	€ 39,70

KALIN DİŞ	
BSW	SON
1/8x40	€ 6,40
3/16x24	€ 6,40
1/4x20	€ 6,40
5/16x18	€ 7,10
3/8x16	€ 7,40
7/16x14	€ 9,80
1/2x12	€ 11,20
9/16x12	€ 18,60
5/8x11	€ 23,00
11/16x11	€ 28,00
3/4x10	€ 28,00
7/8x9	€ 40,40
1"x8	€ 40,40

İNCE DİŞ	
UNF	SON
4x48	€ 9,80
6x40	€ 9,80
8x36	€ 9,80
10x32	€ 9,80
1/4x28	€ 6,40
5/16x24	€ 7,10
3/8x24	€ 7,40
7/16x20	€ 9,80
1/2x20	€ 11,20
9/16x18	€ 18,60
5/8x18	€ 23,00
3/4x16	€ 28,00
7/8x14	€ 40,40
1"x12	€ 40,40
1"x14	€ 40,40

KALIN DİŞ	
UNC	SON
2x56	€ 9,80
4x40	€ 9,80
5x40	€ 9,80
6x32	€ 9,80
8x32	€ 9,80
10x24	€ 9,80
12x24	€ 9,80
1/4x20	€ 6,40
5/16x18	€ 7,10
3/8x16	€ 7,40
7/16x14	€ 9,80
1/2x13	€ 11,20
9/16x12	€ 18,60
5/8x11	€ 23,00
3/4x10	€ 28,00
7/8x9	€ 40,40
1"x8	€ 40,40

BORU DİŞ	
G-BSP	SON
1/8x28	€ 18,60
1/4x19	€ 23,50
3/8x19	€ 30,60
1/2x14	€ 49,90
5/8x14	€ 73,40
3/4x14	€ 73,40
1"x11	€ 116,80

HELİ-COİL 2'Lİ KILAVUZLAR



METRİK-İNCE DİŞ	
MM-Mf	2'li
26x1,5	€ 130,50
27x1,5	€ 130,50
27x2	€ 130,50
27x3	€ 130,50
28x1,5	€ 130,50
30x1,5	€ 171,20
30x2	€ 171,20
30x3,5	€ 171,20
33x2	€ 177,60
33x3,5	€ 177,60
36x1,5	€ 198,00
36x2	€ 198,00
36x3	€ 198,00
36x4	€ 198,00

KALIN DİŞ	
UNC	2'li
1.1/8x7	€ 123,10
1.1/4x7	€ 147,70
1.3/8x6	€ 176,60
1.1/2x6	€ 236,50

İNCE DİŞ	
UNF	2'li
1.1/8x12	€ 123,10
1.1/4x12	€ 147,70
1.3/8x12	€ 176,60
1.1/2x12	€ 236,50

HELİ-COİL YAYLAR



MM-Mf	Paket Adedi	1.D	1,5.D	2.D	2,5.D	3.D
2x0,4	100	€ 0,52	€ 0,67	€ 0,78	€ 0,88	€ 1,10
2,2x0,45	100	€ 0,52	€ 0,67	€ 0,78	€ 0,88	€ 1,10
2,5x0,45	100	€ 0,15	€ 0,17	€ 0,18	€ 0,21	€ 0,25
3x0,5	100	€ 0,15	€ 0,17	€ 0,18	€ 0,21	€ 0,25
3,5x0,6	100	€ 0,18	€ 0,19	€ 0,20	€ 0,23	€ 0,28
4x0,7	100	€ 0,15	€ 0,17	€ 0,18	€ 0,21	€ 0,23
5x0,8	100	€ 0,18	€ 0,14	€ 0,20	€ 0,24	€ 0,29
6x1	100	€ 0,19	€ 0,15	€ 0,23	€ 0,28	€ 0,34
7x1	100	€ 0,21	€ 0,25	€ 0,28	€ 0,33	€ 0,40
8x1	100	€ 0,23	€ 0,23	€ 0,28	€ 0,33	€ 0,40
8x1,25	100	€ 0,20	€ 0,20	€ 0,28	€ 0,33	€ 0,40
9x1,25	100	€ 0,28	€ 0,37	€ 0,37	€ 0,41	€ 0,48
10x1	100	€ 0,25	€ 0,28	€ 0,32	€ 0,39	€ 0,46
10x1,25	100	€ 0,25	€ 0,28	€ 0,32	€ 0,39	€ 0,46
10x1,5	100	€ 0,25	€ 0,28	€ 0,32	€ 0,39	€ 0,46
11x1,5	100	€ 0,42	€ 0,47	€ 0,51	€ 0,62	€ 0,69
12x1	100	€ 0,37	€ 0,43	€ 0,48	€ 0,57	€ 0,69
12x1,25	100	€ 0,37	€ 0,43	€ 0,48	€ 0,57	€ 0,69
12x1,5	100	€ 0,37	€ 0,43	€ 0,48	€ 0,57	€ 0,69
12x1,75	100	€ 0,37	€ 0,43	€ 0,48	€ 0,57	€ 0,69
14x1	50	€ 0,64	€ 0,66	€ 0,76	€ 0,92	€ 1,10
14x1,25	50	€ 0,53	€ 0,61	€ 0,63	€ 0,76	€ 0,92
14x1,5	50	€ 0,53	€ 0,61	€ 0,63	€ 0,76	€ 0,92
14x2	50	€ 0,53	€ 0,61	€ 0,63	€ 0,76	€ 0,92
16x1,5	50	€ 0,72	€ 0,75	€ 0,92	€ 1,01	€ 1,10
16x2	50	€ 0,72	€ 0,75	€ 0,92	€ 1,01	€ 1,10
18x1,5	25	€ 1,05	€ 1,21	€ 1,65	€ 1,87	€ 2,20
18x2	25	€ 1,05	€ 1,21	€ 1,65	€ 1,87	€ 2,20
18x2,5	25	€ 1,05	€ 1,21	€ 1,65	€ 1,87	€ 2,20
20x1,5	25	€ 1,21	€ 1,54	€ 1,98	€ 2,20	€ 2,53
20x2	25	€ 1,21	€ 1,54	€ 1,98	€ 2,20	€ 2,53
20x2,5	25	€ 1,21	€ 1,54	€ 1,98	€ 2,20	€ 2,53
22x1,5	25	€ 1,32	€ 1,65	€ 2,09	€ 2,42	€ 2,75
22x2	25	€ 1,32	€ 1,65	€ 2,09	€ 2,42	€ 2,75
22x2,5	25	€ 1,32	€ 1,65	€ 2,09	€ 2,42	€ 2,75
24x1,5	25	€ 1,65	€ 1,76	€ 2,20	€ 2,64	€ 3,08
24x2	25	€ 1,65	€ 1,76	€ 2,20	€ 2,64	€ 3,08
24x3	25	€ 1,65	€ 1,76	€ 2,20	€ 2,64	€ 3,08

Buji	Paket Adedi	8,4mm	12,4mm	16,4mm
M.14x1,25	50	€ 0,61	€ 0,61	€ 0,61

BSW	Paket Adedi	1.D	1,5.D	2.D	2,5.D	3.D
1/8x40	100	€ 0,61	€ 0,70	€ 1,10	€ 1,24	€ 1,33
3/16x24	100	€ 0,61	€ 0,70	€ 1,10	€ 1,24	€ 1,33
1/4x20	100	€ 0,26	€ 0,29	€ 0,33	€ 0,44	€ 0,47
5/16x18	100	€ 0,31	€ 0,35	€ 0,39	€ 0,46	€ 0,56
3/8x16	100	€ 0,54	€ 0,58	€ 0,68	€ 0,80	€ 0,97
7/16x14	100	€ 0,66	€ 0,73	€ 0,84	€ 0,99	€ 1,21
1/2x12	100	€ 0,66	€ 0,73	€ 0,84	€ 0,99	€ 1,21
9/16x12	50	€ 1,65	€ 2,31	€ 2,72	€ 3,23	€ 3,96
5/8x11	50	€ 1,65	€ 2,31	€ 2,72	€ 3,23	€ 3,96
3/4x10	25	€ 2,13	€ 2,75	€ 3,36	€ 4,03	€ 4,83
7/8x9	10	€ 2,75	€ 3,85	€ 4,81	€ 5,79	€ 6,94
1"x8	10	€ 2,97	€ 4,40	€ 4,81	€ 5,79	€ 6,94
1.1/8x7	10	€ 9,33	€ 11,28	€ 15,32		
1.1/4x7	10	€ 10,52	€ 13,83	€ 18,43		
1.3/8x6	10		€ 37,33			
1.1/2x6	10	€ 20,23	€ 28,44	€ 34,48		

HELİ-COİL YAYLAR



UNC	Paket Adedi	1.D	1,5.D	2.D	2,5.D	3.D
2x56	100	€ 0,52	€ 0,61	€ 0,78	€ 0,88	€ 1,10
4x40	100	€ 0,20	€ 0,19	€ 0,20	€ 0,23	€ 0,28
5x40	100	€ 0,21	€ 0,22	€ 0,23	€ 0,28	€ 0,33
6x32	100	€ 0,15	€ 0,18	€ 0,19	€ 0,21	€ 0,24
8x32	100	€ 0,15	€ 0,18	€ 0,19	€ 0,21	€ 0,24
10x24	100	€ 0,20	€ 0,20	€ 0,22	€ 0,26	€ 0,32
12x24	100	€ 0,21	€ 0,23	€ 0,25	€ 0,31	€ 0,37
1/4x20	100	€ 0,21	€ 0,23	€ 0,25	€ 0,31	€ 0,37
5/16x18	100	€ 0,28	€ 0,33	€ 0,35	€ 0,42	€ 0,51
3/8x16	100	€ 0,43	€ 0,43	€ 0,56	€ 0,64	€ 0,76
7/16x14	100	€ 0,47	€ 0,57	€ 0,65	€ 0,77	€ 0,95
1/2x13	100	€ 0,51	€ 0,57	€ 0,65	€ 0,77	€ 0,95
9/16x12	50	€ 1,65	€ 2,20	€ 2,83	€ 3,23	€ 3,91
5/8x11	50	€ 1,50	€ 2,00	€ 2,49	€ 2,98	€ 3,55
3/4x10	25	€ 1,74	€ 2,37	€ 2,95	€ 3,50	€ 4,19
7/8x9	10	€ 2,31	€ 3,47	€ 4,40	€ 5,20	€ 6,31
1"x8	10	€ 2,31	€ 3,47	€ 4,40	€ 5,20	€ 6,31

UNF	Paket Adedi	1.D	1,5.D	2.D	2,5.D	3.D
4x48	100	€ 0,46	€ 0,53	€ 0,70	€ 0,78	€ 0,99
6x40	100	€ 0,46	€ 0,53	€ 0,70	€ 0,78	€ 0,99
8x36	100	€ 0,46	€ 0,53	€ 0,70	€ 0,78	€ 0,99
10x32	100	€ 0,20	€ 0,21	€ 0,25	€ 0,31	€ 0,37
1/4x28	100	€ 0,20	€ 0,21	€ 0,25	€ 0,31	€ 0,37
5/16x24	100	€ 0,28	€ 0,30	€ 0,35	€ 0,42	€ 0,51
3/8x24	100	€ 0,41	€ 0,43	€ 0,52	€ 0,63	€ 0,76
7/16x20	100	€ 0,51	€ 0,57	€ 0,65	€ 0,77	€ 0,95
1/2x20	100	€ 0,51	€ 0,57	€ 0,65	€ 0,77	€ 0,95
9/16x18	50	€ 1,20	€ 1,20	€ 1,44	€ 1,65	€ 2,02
5/8x18	50	€ 1,20	€ 1,20	€ 1,44	€ 1,65	€ 2,02
3/4x16	25	€ 1,98	€ 2,75	€ 3,32	€ 4,03	€ 4,83
7/8x14	10	€ 2,68	€ 3,96	€ 5,04	€ 5,79	€ 6,94
1"x12	10	€ 2,68	€ 3,96	€ 5,04	€ 5,79	€ 6,94

BSF	Paket Adedi	1.D	1,5.D	2.D	2,5.D	3.D
3/16x32	100	€ 0,61	€ 0,70	€ 1,10	€ 1,24	€ 1,33
1/4x26	100	€ 0,26	€ 0,29	€ 0,33	€ 0,40	€ 0,47
5/16x22	100	€ 0,29	€ 0,35	€ 0,39	€ 0,46	€ 0,56
3/8x20	100	€ 0,54	€ 0,58	€ 0,68	€ 0,80	€ 0,97
7/16x18	100	€ 0,66	€ 0,73	€ 0,84	€ 0,99	€ 1,21
1/2x16	100	€ 0,66	€ 0,73	€ 0,84	€ 0,99	€ 1,21
9/16x16	100	€ 1,65	€ 2,20	€ 2,72	€ 3,23	€ 3,96
5/8x14	50	€ 1,65	€ 2,20	€ 2,72	€ 3,23	€ 3,96
3/4x12	50	€ 2,13	€ 2,75	€ 3,36	€ 4,03	€ 4,83
7/8x11	25	€ 2,75	€ 3,85	€ 4,81	€ 5,79	€ 6,94
1"x10	10	€ 2,75	€ 3,85	€ 4,81	€ 5,79	€ 6,94

G-BSP	Paket Adedi	1,5.D
1/8x28	100	€ 0,44
1/4x19	100	€ 0,66
3/8x19	50	€ 0,77
1/2x14	25	€ 0,99
5/8x14	10	€ 2,48
3/4x14	5	€ 2,48
7/8x14	5	€ 7,59
1"x11	5	€ 7,59

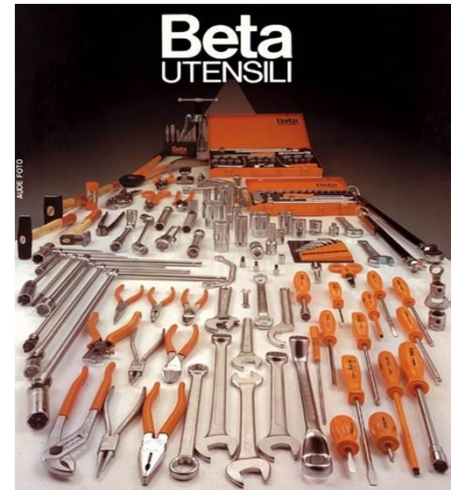
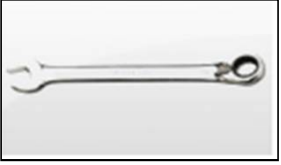
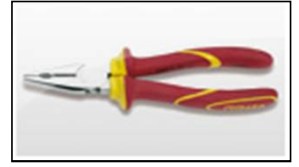

ORIJINAL GÜNCEL BETA FİYAT KATALOĞUNU FİRMAMIZDAN İSTEYİNİZ.

LUPAMAT



TEK KADEMELİ PİSTONLU HAVA KOMPRESÖRLERİ				
Ürün Kodu	Basınç (bar)	Piston Deplas. (lt/dk)	Motor Gücü (Hp)	Depo Hacmi
LKD 41-300 Mono	8	200	1,5	50
LKD 61-330 A	8	370	3	200
LKD 61-440	8	535	4	200
LKD 61-550 A	8	900	7,5	500
LKD 61-555	8	1454	10	500

ÇİFT KADEMELİ PİSTONLU HAVA KOMPRESÖRLERİ				
Ürün Kodu	Basınç (bar)	Piston Deplas. (lt/dk)	Motor Gücü (Hp)	Depo Hacmi
LKD 62-520	15	400	4	200
LKD 62-553 A	15	741	7,5	500



AYDIN TRAFİ



TEK KADEMELİ PİSTONLU HAVA KOMPRESÖRLERİ				
Ürün Kodu	Basınç (bar)	Piston Deplas. (lt/dk)	Motor Gücü (Hp)	Depo Hacmi
11-50M	8	110	1-0,75	50
21-100	8	210	1,5-1,1	100
21-100M	8	210	1,5-1,1	100
21-130	8	275	2-1,5	130
21-130M	8	260	2-1,5	130
21-220	8	260	2-1,5	220
21-220M	8	260	2-1,5	220
21-300/4,0	8	530	4-3	300
21-300/5,5	8	760	5,5-4	300
21-530/5,5	8	760	5,5-4	530
21-530/7,5	8	900	7,5-5,5	530
21-530/10	8	1370	10-7,5	530
21-1000	8	1370	10-7,5	1000

ÇİFT KADEMELİ PİSTONLU HAVA KOMPRESÖRLERİ				
Ürün Kodu	Basınç (bar)	Piston Deplas. (lt/dk)	Motor Gücü (Hp)	Depo Hacmi
22-220	12	200	2-1,5	220
22-220M	12	200	2-1,5	220
22-300/5,5	12	630	5,5-4	300
22-530/5,5	12	630	5,5-4	530
22-530/7,5	12	800	7,5-5,5	530
22-530/10	12	1200	10-7,5	530
22-1000/15	12	1730	15-11	1000



SERVİSLER

MERKEZ SERVİS

SEVAN HIRDAVATÇILIK SAN.TİC.A.Ş.

Keresteci Fazıl Sok.No:10

0 (212) 249 30 00 - 249 49 24 -249 13 75 Fax:249 04 74

www.sevahirdavat.com.tr sevan@sevanhirdavat.com

KARAKÖY - İSTANBUL

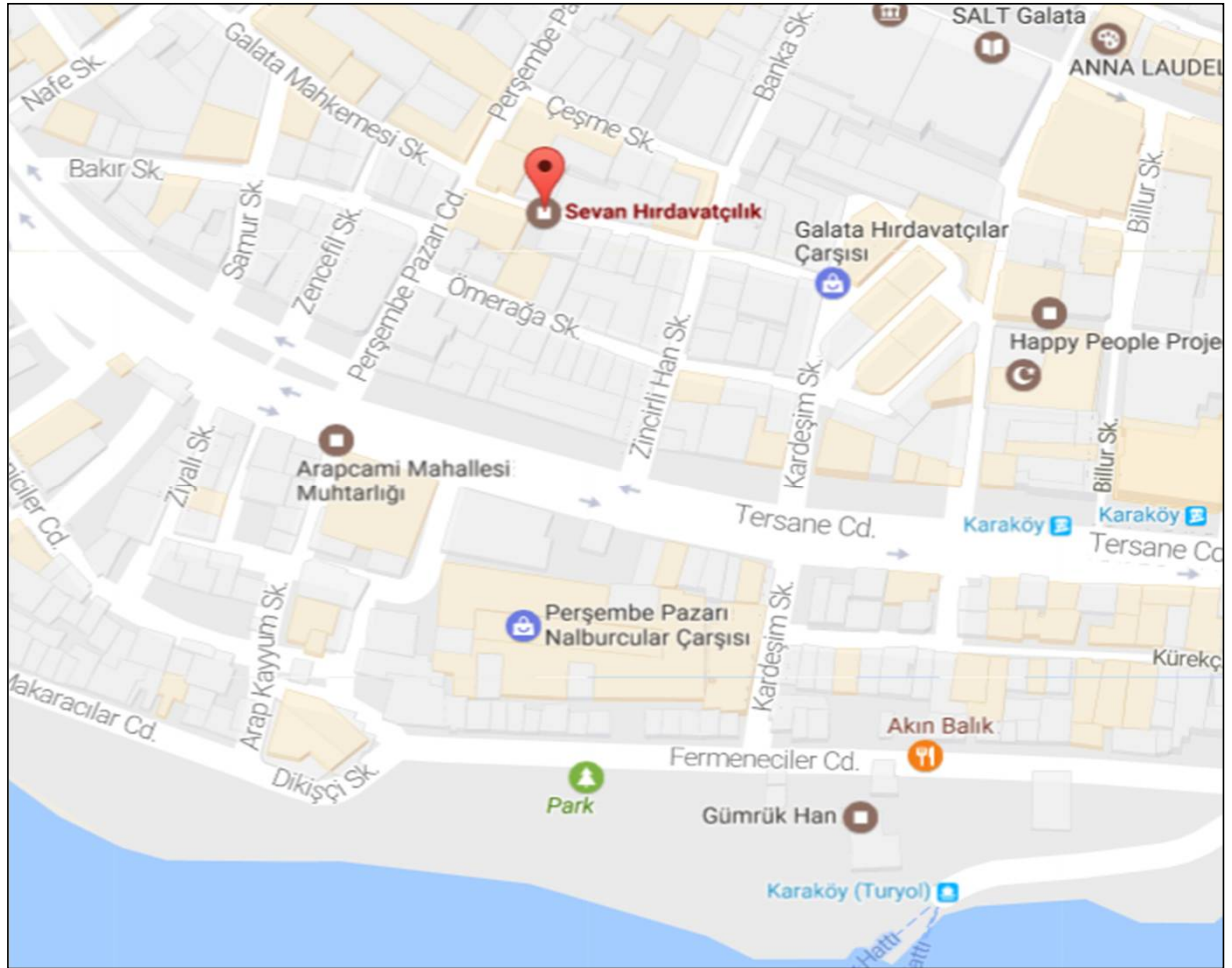

FAYDALI BİLGİLER

INCH-MM STANDART DIŞ SAYILARI VE MATKAP ÖLÇÜLERİ

INCH-MM
ÇEVİRİM

ÖLÇÜ	BSW		UNC		UNF		BSF		GAS		NPT	
	Diş	Mat.	Diş	Mat.	Diş	Mat.	Diş	Mat.	Diş	Mat.	Diş	Mat.
Nr.0					80,00							
Nr.1			64,00	1,50	72,00							
Nr.2			56,00	1,80	64,00							
Nr.3			48,00	2,10	56,00							
Nr.4			40,00	2,35	48,00	2,40						
Nr.5			40,00	2,65	44,00	2,70						
Nr.6			32,00	2,85	40,00	2,95						
Nr.8			32,00	3,50	36,00	3,50						
Nr.10			24,00	4,50	32,00	4,10						
Nr.12			24,00	5,10	28,00	4,70						
1/16"	60,00	1,20							28,00		27,00	6,00-6,30
3/32"	48,00	1,90										
1/8"	40,00	2,55							28,00	8,80	27,00	8,40-8,70
5/32"	32,00	3,20										
3/16"	24,00	3,70					32,00	4,00				
7/32"	24,00	4,50					28,00	4,50				
1/4"	20,00	5,10	20,00	5,10	28,00	5,50	26,00	5,30	19,00	11,80	18,00	10,70-11,10
9/32"							26,00	6,10				
5/16"	18,00	6,50	18,00	6,60	24,00	6,90	22,00	6,80				
3/8"	16,00	7,90	16,00	8,00	24,00	8,50	20,00	8,30	19,00	15,25	18,00	14,25-14,50
7/16"	14,00	9,30	14,00	9,40	20,00	9,90	18,00	9,70				
1/2"	12,00	10,50	13,00	10,80	20,00	11,50	16,00	11,10	14,00	19,00	14,00	17,50-18,00
9/16"	12,00	12,10	12,00	12,20	18,00	12,90	16,00	12,70				
5/8"	11,00	13,50	11,00	13,50	18,00	14,50	14,00	14,00	14,00	21,00		
3/4"	10,00	16,25	10,00	16,50	16,00	17,50	12,00	16,75	14,00	24,50	14,00	22,75-23,25
7/8"	9,00	19,25	9,00	19,50	14,00	20,40	11,00	19,75	14,00	28,25		
1"	8,00	22,00	8,00	22,50	12,00	23,25	10,00	21,75	11,00	30,75	11,50	28,50-29
1.1/8"	7,00	24,75	7,00	25,00	12,00	26,50	9,00	22,50				
1.1/4"	7,00	28,00	7,00	28,00	12,00	29,50	9,00	28,50	11,00	39,50	11,50	37,50-38,50
1.3/8"	6,00	30,50	6,00	30,75	12,00	32,75	8,00	31,50				
1.1/2"	6,00	33,50	6,00	34,00	12,00	36,00	8,00	34,50	11,00	45,00	11,50	43,50-44,00
1.5/8"	5,00	35,50					8,00					
1.3/4"	5,00	39,00	5,00	39,50			7,00	41,00	11,00	51,00		
1.7/8"	4,50	41,50										
2"	4,50	44,50	4,50	45,00			7,00		11,00	57,00	11,50	55,00-56,00
2.1/4"	4,00	50,50	4,50	51,60			6,00		11,00	63,00		
2.1/2"	4,00	57,00	4,00	57,25			6,00		11,00	73,00	8,00	
2.3/4"	3,50	62,00	4,00	63,60			6,00					
3"	3,50	68,00	4,00	69,90			5,00		11,00	86,00	8,00	
3.1/4"	3,25		4,00	76,25			5,00					
3.1/2"	3,25		4,00	82,60			4,50				8,00	
3.3/4"	3,00		4,00	89,00			4,50					
4"	3,00		4,00	95,30			4,50	47,00	11,00		8,00	
4.1/4"							4,00					
5"									11,00		8,00	
6"									11,00		8,00	
8"											8,00	
10"											8,00	
12"											8,00	

ÖLÇÜ	MM		INC	MM
	Diş	Mat.		
1,00	0,25	0,75	1/32"	0,79
1,10	0,25	0,85	1/30"	0,85
1,20	0,25	0,95	1/20"	1,27
1,40	0,30	1,10	1/16"	1,59
1,60	0,35	1,25	5/64"	1,98
1,80	0,35	1,45	3/32"	2,38
2,00	0,40	1,60	7/64"	2,78
2,20	0,45	1,75	1/8"	3,18
2,50	0,45	2,05	9/64"	3,57
3,00	0,50	2,50	5/32"	3,97
3,50	0,60	2,90	3/16"	4,76
4,00	0,70	3,30	7/32"	5,76
4,50	0,75	3,70	1/4"	6,35
5,00	0,80	4,20	9/32"	7,14
6,00	1,00	5,00	5/16"	7,94
7,00	1,00	6,00	11/32"	8,73
8,00	1,25	6,80	3/8"	9,52
9,00	1,25	7,80	13/32"	10,32
10,00	1,50	8,50	7/16"	11,11
11,00	1,50	9,50	15/32"	11,91
12,00	1,75	10,20	1/2"	12,70
14,00	2,00	12,00	17/32"	13,49
16,00	2,00	14,00	9/16"	14,29
18,00	2,50	15,50	19/32"	15,08
20,00	2,50	17,50	5/8"	15,87
22,00	2,50	19,50	21/32"	16,67
24,00	3,00	21,00	11/16"	17,46
27,00	3,00	21,00	23/32"	18,26
30,00	3,50	26,50	3/4"	19,05
33,00	3,50	29,50	25/32"	19,84
36,00	4,00	32,00	13/16"	20,64
39,00	4,00	35,00	27/32"	21,43
42,00	4,50	37,50	7/8"	22,22
45,00	4,50	40,50	29/32"	23,02
48,00	5,00	43,00	15/16"	23,81
52,00	5,00	47,00	31/32"	24,61
56,00	5,50	50,50	1"	25,40
60,00	5,50	54,50	1.1/16"	26,99
64,00	6,00	58,00	1.1/8"	28,57
68,00	6,00	62,00	1.3/16"	30,16
			1.1/4"	31,75
			1.5/16"	33,34
			1.3/8"	34,92
			1.7/16"	36,51
			1.1/2"	38,10
			1.9/16"	39,69
			1.5/8"	41,27
			1.11/16"	42,86
			1.3/4"	44,45
			1.13/16"	46,04
			1.7/8"	47,62
			1.15/16"	49,21
			2"	50,80
			2.1/8"	53,97
			2.1/4"	57,15
			2.3/8"	60,32
			2.1/2"	63,50
			2.5/8"	66,67
			2.3/4"	69,85
			2.7/8"	73,02
			3"	76,20
			3.1/8"	79,37
			3.1/4"	82,55
			3.3/8"	85,72
			3.1/2"	88,90
			3.5/8"	92,07
			3.3/4"	95,25
			3.7/8"	98,42
			3.29/32"	99,22
			3.15/16"	100,01

TORK ÖLÇÜLERİ ÇEVİRİM TABLOSU

	kgcm	kgm	cNm	Nm	lbft	lbin
kgcm	1	0,01	9,8066	0,0980	0,0723	0,8679
kgm	100	1	980,665	9,8066	7,2330	86,7961
cNm	1019,71	10,1971	1	0,01	73,7562	885,074
Nm	10,1971	0,1019	100	1	0,7375	8,8507
lbft	13,8254	0,1382	135,581	1,3558	1	12
lbin	1,1521	0,0115	11,2984	0,1129	0,0833	1

BASINÇ ÖLÇÜLERİ ÇEVİRİM TABLOSU

	atm	at	psi	torr	bar
atm	1	1,0332	14,7	759,999	1,0133
at	0,9678	1	14,2233	735,559	0,9807
psi	0,068	0,07	1	51,7149	0,6894
torr	0,0013	0,0013	0,1933	1	0,0013
bar	0,9863	1,097	14,5038	750,061	1

MM CIVATALARIN ANAHTAR AĞIZ
ÖLÇÜLERİ

Cıvata	MM	Cıvata	MM
1,6	3,2	22	32
2	4	24	36
2,5	5	27	41
3	5,5	30	46
4	7	33	50
5	8	36	55
6	10	39	60
7	11	42	65
8	13	45	70
10	17	48	75
12	19	52	80
14	22	56	85
16	24	60	90
18	27	64	95
20	30	68	100

GARANTİ ŞARTLARI

- 1- TÜKETİCİ; 4077 numaralı Tüketicinin Korunması Hakkındaki Kanunun 3.Maddesi "e" bendinde bir mal veya hizmeti ticari veya mesleki olmayan amaçlarla edinen, kullanan veya yararlanan gerçek veya tüzel kişi olarak tanımlanmaktadır.TÜKETİCİ olarak amatör kullanımlar için garanti süresi 2 (iki) yıldır.
- 2- PROFESYONEL KULLANICI ise alınan mal veya hizmeti ticari veya mesleki amaçlar için kullanan gerçek veya tüzel kişidir. Profesyonel amaçlı kullanımlar için ise garanti süresi 1 (bir) yıldır.
- 3- Garanti kapsamındaki talepler ancak Yetkili Servis'lerde karşılanır ve garantili tamir ve onarımlarının yapılabilmesi için kaşeli, imzalı garanti belgesi veya fatura ibrazı şarttır.
- 4- Malzeme veya imalat hatalarından kaynaklanan hasarlar, hatalı parçanın veya makinenin onarımı veya değiştirilmesi yoluyla telafi edilir. Diğer bakım ve kontroller ücretli olarak yapılır.
- 5- Malın garanti süresi içerisinde gerek malzeme ve işçilik, gerek se montaj hatalarından dolayı arızalanması halinde işçilik masrafı, değiştirilen parça bedeli ya da başka herhangi bir ad altında hiçbir ücret talep etmeksizin tamiri yapılacaktır.
- 6- Havalı aletler için, kullanıldığı hava tesisatına ait standarda uygunluk belgesi aranmaktadır.

GARANTİ KAPSAMINA GİRMİYEN HALLER

- * Garanti belgesi veya faturası ibraz edilemeyen ürünler,
- * Ürünün mevcut yıpranma durumu ile fatura tarihinin uyumlu olmaması, faturanın sonradan düzenlendiğinin tespit edildiği durumlar
- * Kullanım klavuzuna uyulmaması sonucu üründe meydana gelen arızalar,
- * Ürünün üzerinde değişiklik veya ilave yapılmasından kaynaklanan arızalar,
- * Yetkili servislerin dışındaki şahısların ürünü açmaları, müdahale etmeleri ve orijinal olmayan yedek parça kullanmaları sonucu oluşan arızalar,
- * Kullanıma bağlı veya doğal ömrünü tamamlayan parçalar (yağlar,keçeler,contalar,rulmanlar,segmanlar,kanatlar,çekiçler,soketler v.s.),
- * Amaca uygun olmayan kullanım, aşırı zorlama, eksik bakım veya koruma amaçlı aksesuar ve diğer kısımlarda meydana gelen arızalar (muhafazalar, pensler,mandrenler,hortumlar,rakorlar,nipeller v.s.),
- * Anormal çevre şartları ve uygunsuz işletme şartlarında kullanım, ürünün içine toz toprak, çapak, sıvı girmesine karşın temizliğinin yapılmadan kullanılmasıyla oluşan arızalar,
- * Orijinal olmayan veya yıpranmış, körelmiş, aksesuarların kullanımı sonucu oluşan hasar ve arızalar,
- * Uygun olmayan yağ, yağsız kullanım ve basınçlı hava kullanımına bağlı arızalar,
- * Gerekli bakımlarının yapılmamasından kaynaklanan arızalar,
- * Hatalı ürün seçiminden kaynaklanan arızalar (Profesyonel ürün yerine hafif işlerde kullanım için üretilmiş ürün seçilmesi v.s.),
- * Ürünün tesliminden sonra nakliye, boşaltma, yükleme, harici fiziki (kırık,çatlak,çizik,ezilme vb) ve kimyevi etkenlerden meydana gelen arıza ve hasarlar,
- * Yangın, yıldırım düşmesi, donma ve doğal afetlerden kaynaklanan arızalar,
- * Savaş, terör, gösteri ve eylemler sonucu oluşan arıza ve hasarlar,

GARANTİ KAPSAMINA GİRMEMEKTEDİR.

BAKIM ONARIM ŞARTLARI

- * Tamir için verilen fiyat teklifleri 2 ay geçerlidir.
- * Tamirin tamamlandığı ve onarım ücreti müşteriye bildirildikten sonra o ay içinde alınmayan ürünler için teslim ayındaki döviz kuru ile çarpılan yeni fiyatlar uygulanır.
- * Yetkili servislerimizde ücretli değiştirilen parçalar 6 (altı) ay garantilidir.
- * Onarım sırasında ücretli değiştirilen parçalar, müşteriye onarım bitiminde teslim edilmekte olup teslim alınmayan arızalı parçalar firmamız tarafından imha edilir.Müşteri teslim almadığı arızalı parçalar için hak iddia edemez.



Not: